

FLSN

Atmospheres containing explosive GAS



totally enclosed three-phase asynchronous motors

**CATEGORY 3
ZONE 2**

General information

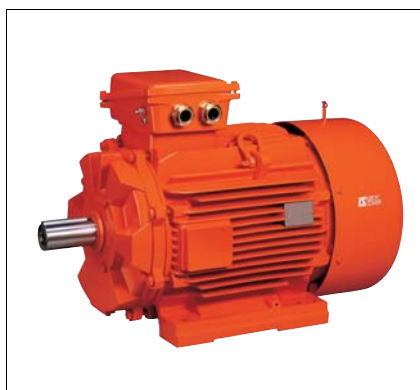

Motors in accordance with the European Directive 94/9/CE.

Non-sparking totally enclosed three-phase asynchronous motors, FLSN series, according to IEC 60034, 60072, EN 50019 and 50021.

- Single speed : power 0.18 to 400 kW¹, frame size 80 to 355 mm, 2, 4, 6, 8 poles; 230/400 V or 400 V Δ, 50 Hz.
- Two speed : on request.

IP 55 protection
(or IP 65 for GD application)

Motors for variable speed operation :

- fitted with thermal probes in winding (obligatory) and bearing probes for frame size ≥ 160 mm ;
- on consultation (for selection).

Finish : cast iron casing

Assembled with protected screws.
Finishing paint **RAL 2004 (orange)**.
Protection of the flange and shaft end against atmospheric corrosion.
Individual anti-shock packaging.

Mains supply

- Standard construction according to IEC 60038 :
- 230/400 V +10% -10% at 50 Hz ;
- 400 V Δ +10% -10% at 50 Hz.

1. Other powers : consult us.



Description of the FLSN three-phase motors



II 3G EEx nA II T3 (T125)

Component	Material	Remarks
Finned housing	Cast iron	- with bolt-on or cast foot, or without foot <ul style="list-style-type: none"> • 4 or 6 mounting holes for the foot housings • lifting rings - earth terminal
Stator	Insulated low carbon magnetic steel laminations Enameled electrolytic copper	- the low carbon content guarantees long term stability of the characteristics - assembled lamination pack - semi-enclosed slots - insulation system class F
Rotor	Insulated low carbon magnetic steel laminations Aluminium	- inclined slots - squirrel cage pressure die cast in aluminium (or alloy for special applications) - keyed or mounted on the shaft by heat shrinking - dynamically balanced rotor class N - 1/2 key
Shaft	Steel	- for frame size < 132 : <ul style="list-style-type: none"> • shaft end fitted with screw and washer • closed keyway - for frame size ≥ 132 : <ul style="list-style-type: none"> • tapped centre hole • open key
End shields	Cast iron	- all frame sizes
Bearings		- ball bearings - rear preloaded bearings
Labyrinth seals Lipseals	Technopolymer or steel Synthetic rubber	- lipseals sealing - front or rear jet deflector or labyrinth seals
Fan	Composite material or aluminium alloy	- 2 directions of rotation : straight blades
Fan cover	Sheet steel	- on request, fitted with a drip cover for operation in vertical position, shaft facing down
Terminal box	Cast iron	- IP 55 or IP 65 for «GD» application - rotatable, mounted opposite to foot - fitted with a 6 stud safety certified terminal board EEx e for frame sizes ≤ 132 and with insulators thereafter - supplied fitted with EEx e safety certified fitted cable glands (type CMDEL) - 1 earth terminal in all terminal boxes (2 from FLSN 160)

FLSN

Atmospheres containing explosive GAS



totally enclosed three-phase asynchronous motors

**CATEGORY 3
ZONE 2**

Mounting positions

Foot mounted motors

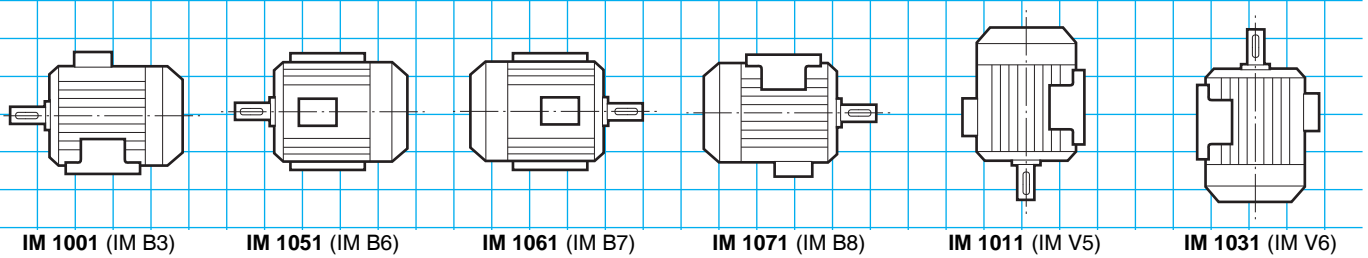

(FF) plain hole flange mounted motors

- Possible position IM 3001 (IM B5) up to 225 frame size inclusive

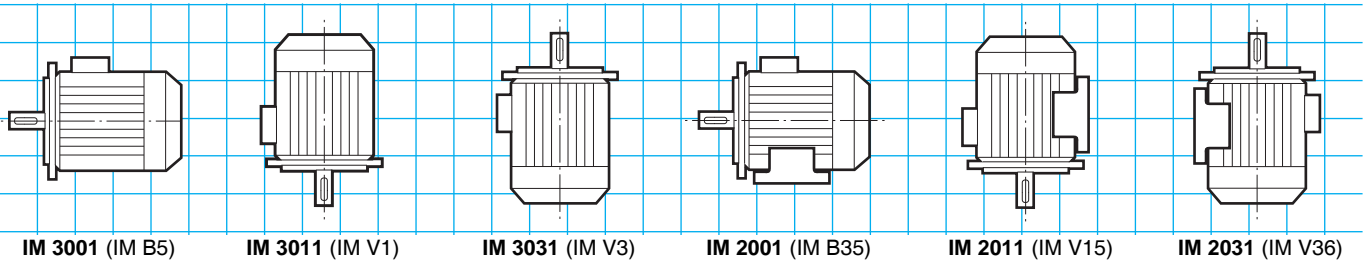

(FT) tapped hole flange mounted motors

- Possible positions up to 132 frame size inclusive

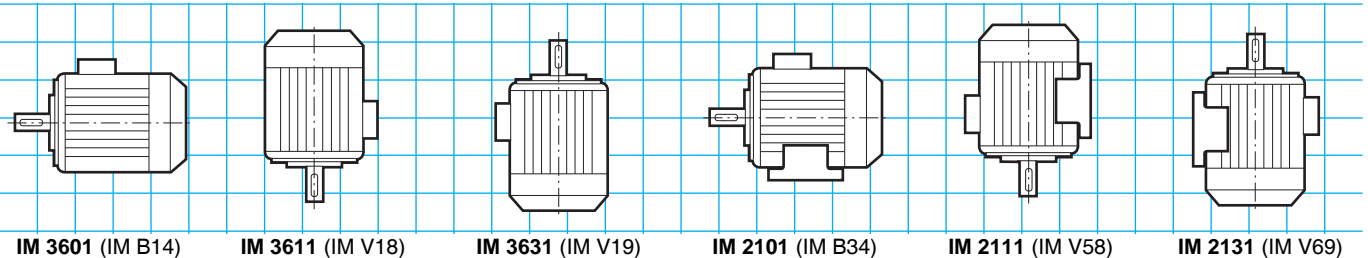

Terminal box position in relation to the motor shaft end

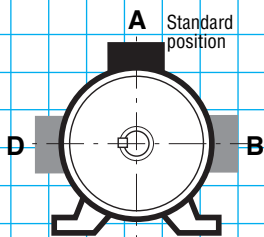

A : standard

Cable gland position in relation to the motor shaft end

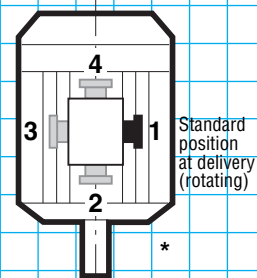

1 : standard

* Position 2 not recommended and not feasible on plain hole flange standard motor (FF)

FLSN

Atmospheres containing explosive GAS



totally enclosed three-phase asynchronous motors

**CATEGORY 3
ZONE 2**

Adaptation possibilities

Leroy-Somer offers, for use with the FLSN totally enclosed three-phase asynchronous motors, many options which meet the needs of highly diverse applications. They are described below and in the chapters relating to gearboxes and to speed variation. For other variants or any special adaptation, consult the technical specialists at Leroy-Somer.



The FLSN three-phase motors may be associated :

- gearboxes
- electronic variable speed drives (1)

The options (according to advice) :

- drip cover
- anti-blocking cover
- forced ventilation (frame size ≥ 160)
- thermal protection
- brass cable glands
- cable glands of different dimensions
- cable output
- merchant navy finish
- stainless steel plate
- second shaft end
- non standard flanges

(1) Conforming to the regulations of use as indicated by the standard IEC 34-17.

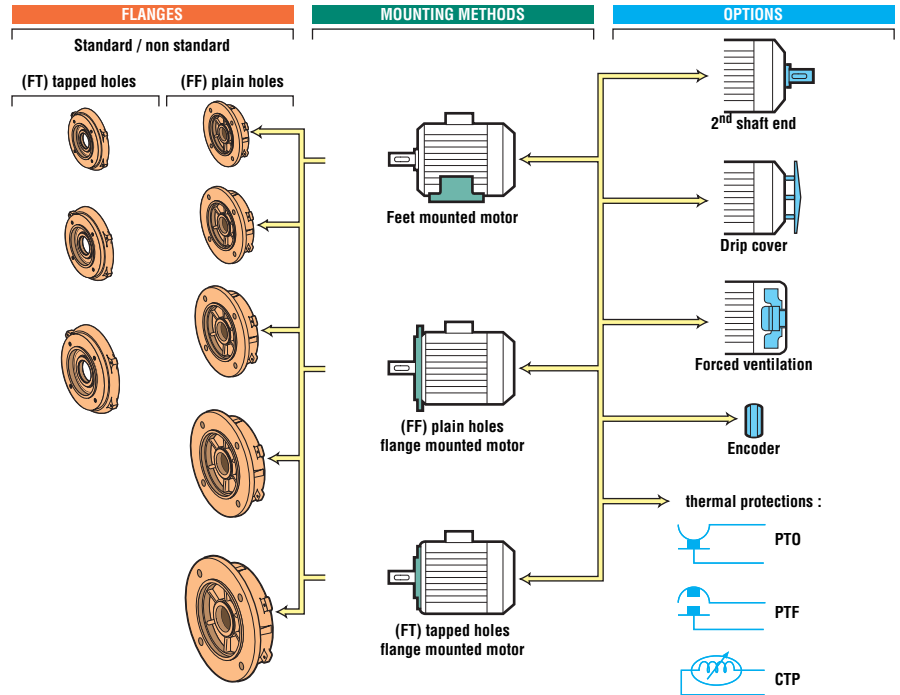

Designation / Codification

ATEX II 3G T1... T3	4P 1500 min⁻¹	FLSN	180	MR	18.5 kW	IM 1001 (IM B3)	400 VΔ	50 Hz	IP 55
Specific application	Speed polarity	Motor type	IEC 60072-1 frame size	Housing designation and builder index	Rated power	IEC 60034-7 mounting position	Power supply voltage	Power supply frequency	IEC 60034-5 protection

Codification example :

FLSN three-phase motor, 1500 min⁻¹, 18.5 kW
IM 1001 (IM B3), 400 V

Designation	Code
4P LS 180 MR 18.5 kW IM 1001 (IM B3) 400 V	-

The table above is an example. It allows the creation of the designation for the required product. This designation corresponds to a product code. The product codes that are present in the selection grids can be used directly. They simplify the ordering process. The codification table is incorporated in the price list with the designations list.

FLSN

Atmospheres containing explosive GAS



totally enclosed three-phase asynchronous motors

Selection

**CATEGORY 3
ZONE 2**

IP 55 - 50 Hz - Class F - Δ T 80 K - 230 V Δ / 400 V Y or 400 V Δ - S1
 II - 3G - EEx nA II T3

**2
poles
3000 min⁻¹**

Type	Rated power at 50 Hz	Rated speed	Rated moment	Rated current	Power factor	Efficiency	Starting torque / Rated torque	Weight
	P_N kW	N_N min ⁻¹	M_N N.m	$I_N(400V)$ A	$\cos \varphi$ 100 %	η 100 %	I_D / I_N	IM B3 kg
FLSN 80 L	0.75	2840	2.5	1.6	0.86	76.9	5.9	15
FLSN 80 L	1.1	2837	3.7	2.4	0.84	79.5	5.6	18
FLSN 90 S	1.5	2870	5	3.3	0.81	82	7.3	21
FLSN 90 L	2.2	2862	7.5	4.3	0.88	84.5	8.1	26
FLSN 100 LK	3	2925	10	5.5	0.91	86	8.4	42
FLSN 112 M	4	2940	13.6	7.5	0.89	86.5	8.7	48
FLSN 132 S	5.5	2940	18.7	10.6	0.86	87	7.6	67
FLSN 132 S	7.5	2950	25	14.1	0.87	88	8.9	70
FLSN 160 MA	11	2935	35.8	20	0.88	88.4	8.6	97
FLSN 160 MB	15	2935	48.8	27	0.88	89.7	8.6	108
FLSN 160 L	18.5	2940	60	33	0.9	90.8	8.4	126
FLSN 180 MR	22	2940	71	39	0.89	91	8.5	135
FLSN 200 LA	30	2950	97	51	0.91	92.4	7.7	245
FLSN 200 LB	37	2959	120	63	0.9	93.5	8.3	265
FLSN 225 MT	45	2958	145	78	0.89	93.8	8.3	290
FLSN 250 M	55	2966	177	94	0.89	94.6	7.9	405
FLSN 280 S	75	2965	241	127	0.9	94.6	8	505
FLSN 280 M	90	2962	290	149	0.91	95.5	7.7	560
FLSN 315 ST	110	2975	356	178	0.93	95.8	8.2	850
FLSN 315 M	132	2962	427	221	0.9	96	7.5	1000
FLSN 315 LA	160	2969	517	272	0.89	95.5	7.5	1050
FLSN 315 LB	200	2967	647	342	0.88	96	7.7	1150
FLSN 355 LA	250	2978	808	424	0.89	95.6	7.2	1400
FLSN 355 LB	315	2976	1016	525	0.9	96.2	7.2	1500
FLSN 355 LC	355	2979	1137	588	0.9	96.8	8.2	1915
FLSN 355 LD	400	2977	1284	673	0.89	96.4	7.8	1915

FLSN

Atmospheres containing explosive GAS



totally enclosed three-phase asynchronous motors

Selection

**CATEGORY 3
ZONE 2**

IP 55 - 50 Hz - Class F - Δ T 80 K - 230 V Δ / 400 V Y or 400 V Δ - S1
 II - 3G - EEx nA II T3

**2
poles
3000 min⁻¹**

A

Type	Rated power at 50 Hz P_N kW	IM 1001 (IM B3)		IM 3001 (IM B5)		IM 2001 (IM B35)		IM 3601 (IM B14)		IM 2101 (IM B34)	
		Code	Qty	Code	Qty	Code	Qty	Code	Qty	Code	Qty
FLSN 80 L	0.75		-		-		-		-		-
FLSN 80 L	1.1		-		-		-		-		-
FLSN 90 S	1.5		-		-		-		-		-
FLSN 90 L	2.2		-		-		-		-		-
FLSN 100 LK	3		-		-		-		-		-
FLSN 112 M	4		-		-		-		-		-
FLSN 132 S	5.5		-		-		-		-		-
FLSN 132 S	7.5		-		-		-		-		-
FLSN 160 MA	11		-		-		-		-		-
FLSN 160 MB	15		-		-		-		-		-
FLSN 160 L	18.5		-		-		-		-		-
FLSN 180 MR	22		-		-		-		-		-
FLSN 200 LA	30		-		-		-		-		-
FLSN 200 LB	37		-		-		-		-		-
FLSN 225 MT	45		-		-		-		-		-
FLSN 250 M	55		-		-		-		-		-
FLSN 280 S	75		-		-		-		-		-
FLSN 280 M	90		-		-		-		-		-
FLSN 315 ST	110		-		-		-		-		-
FLSN 315 M	132		-		-		-		-		-
FLSN 315 LA	160		-		-		-		-		-
FLSN 315 LB	200		-		-		-		-		-
FLSN 355 LA	250		-		-		-		-		-
FLSN 355 LB	315		-		-		-		-		-
FLSN 355 LC	355		-		-		-		-		-
FLSN 355 LD	400		-		-		-		-		-

FLSN

Atmospheres containing explosive GAS



totally enclosed three-phase asynchronous motors

Selection

**CATEGORY 3
ZONE 2**

IP 55 - 50 Hz - Class F - Δ T 80 K - 230 V Δ / 400 V Y or 400 V Δ - S1
 II - 3G - EEx nA II T3

**4
poles
1500 min⁻¹**

A

Type	Rated power at 50 Hz	Rated speed	Rated moment	Rated current	Power factor	Efficiency	Starting torque / Rated torque	Weight
	P_N kW	N_N min ⁻¹	M_N N.m	$I_N^{(400V)}$ A	$\cos \varphi$ 100 %	η 100 %	I_D / I_N	IM B3 kg
FLSN 80 L	0.55	1410	3.7	1.6	0.74	69.2	4.4	15
FLSN 80 L	0.75	1425	5	2	0.75	72.5	5.7	17
FLSN 90 S	1.1	1429	7.5	2.5	0.83	78	4.9	19
FLSN 90 L	1.5	1428	10	3.3	0.82	79.5	5.3	21
FLSN 90 L	1.8	1438	12.3	4	0.82	80.1	5.9	23
FLSN 100 LK	2.2	1457	15	4.6	0.83	83.8	6.3	41
FLSN 100 LK	3	1454	20	6.2	0.82	84.7	6.5	44
FLSN 112 M	4	1462	27.5	8.4	0.81	85.1	7.4	48
FLSN 132 S	5.5	1467	37	10.9	0.84	87	8	65
FLSN 132 M	7.5	1450	50	14.3	0.87	87	7.3	70
FLSN 132 M	9	1449	61	16.8	0.88	87.7	7.6	75
FLSN 160 M	11	1455	72.2	21	0.86	88.5	7.8	103
FLSN 160 L	15	1455	98.5	28	0.86	89.5	7.8	120
FLSN 180 MR	18.5	1465	120	35	0.86	90	7.8	135
FLSN 180 L	22	1465	143	41	0.86	91.4	7.4	184
FLSN 200 L	30	1471	195	56	0.85	91.9	6.5	260
FLSN 225 ST	37	1476	240	70	0.82	93.6	7	290
FLSN 225 M	45	1483	290	79	0.87	94.5	7	388
FLSN 250 M	55	1479	355	101	0.84	94.5	6.5	395
FLSN 280 S	75	1483	484	137	0.84	94.9	7.7	475
FLSN 280 M	90	1478	581	162	0.85	95	7.6	565
FLSN 315 ST	110	1482	710	203	0.83	94.8	7.3	850
FLSN 315 M	132	1489	850	249	0.81	95	8	1000
FLSN 315 LA	160	1486	1032	285	0.85	95.8	7.5	1050
FLSN 315 LB	200	1487	1291	369	0.82	96	8	1150
FLSN 355 LA	250	1487	1611	427	0.88	96.5	7.4	1510
FLSN 355 LB	300	1489	1930	520	0.87	96.3	6.5	1550
FLSN 355 LC	355	1489	2279	619	0.86	96.8	6.6	1800
FLSN 355 LD	400	1489	2564	689	0.87	96.8	7.4	1930

FLSN

Atmospheres containing explosive GAS



totally enclosed three-phase asynchronous motors

Selection

**CATEGORY 3
ZONE 2**

IP 55 - 50 Hz - Class F - Δ T 80 K - 230 V Δ / 400 V Y or 400 V Δ - S1
 II - 3G - EEx nA II T3

**4
poles
1500 min⁻¹**

A

Type	Rated power at 50 Hz P_N kW	IM 1001 (IM B3)		IM 3001 (IM B5)		IM 2001 (IM B35)		IM 3601 (IM B14)		IM 2101 (IM B34)	
		Code	Qty	Code	Qty	Code	Qty	Code	Qty	Code	Qty
FLSN 80 L	0.55		-		-		-		-		-
FLSN 80 L	0.75		-		-		-		-		-
FLSN 90 S	1.1		-		-		-		-		-
FLSN 90 L	1.5		-		-		-		-		-
FLSN 90 L	1.8		-		-		-		-		-
FLSN 100 LK	2.2		-		-		-		-		-
FLSN 100 LK	3		-		-		-		-		-
FLSN 112 M	4		-		-		-		-		-
FLSN 132 S	5.5		-		-		-		-		-
FLSN 132 M	7.5		-		-		-		-		-
FLSN 132 M	9		-		-		-		-		-
FLSN 160 M	11		-		-		-		-		-
FLSN 160 L	15		-		-		-		-		-
FLSN 180 MR	18.5		-		-		-		-		-
FLSN 180 L	22		-		-		-		-		-
FLSN 200 L	30		-		-		-		-		-
FLSN 225 ST	37		-		-		-		-		-
FLSN 225 M	45		-		-		-		-		-
FLSN 250 M	55		-		-		-		-		-
FLSN 280 S	75		-		-		-		-		-
FLSN 280 M	90		-		-		-		-		-
FLSN 315 ST	110		-		-		-		-		-
FLSN 315 M	132		-		-		-		-		-
FLSN 315 LA	160		-		-		-		-		-
FLSN 315 LB	200		-		-		-		-		-
FLSN 355 LA	250		-		-		-		-		-
FLSN 355 LB	300		-		-		-		-		-
FLSN 355 LC	355		-		-		-		-		-
FLSN 355 LD	400		-		-		-		-		-

FLSN

Atmospheres containing explosive GAS



totally enclosed three-phase asynchronous motors

Selection

**CATEGORY 3
ZONE 2**

IP 55 - 50 Hz - Class F - Δ T 80 K - 230 V Δ / 400 V Y or 400 V Δ - S1

II - 3G - EEx nA II T3

6
poles
1000 min⁻¹

A

Type	Rated power at 50 Hz	Rated speed	Rated moment	Rated current	Power factor	Efficiency	Starting torque / Rated torque	Weight
	P_N kW	N_N min ⁻¹	M_N N.m	$I_N(400V)$ A	$\cos \varphi$ 100 %	η 100 %	I_D / I_N	IM B3 kg
FLSN 80 L	0.25	950	2.5	0.8	0.74	60.3	3.6	14
FLSN 80 L	0.37	940	3.7	1.2	0.74	61	3.8	15
FLSN 80 L	0.55	955	5.5	1.8	0.67	65	4.4	16
FLSN 90 S	0.75	940	7.5	2.1	0.8	65.2	3.5	21
FLSN 90 L	1.1	940	11	2.7	0.81	73.5	4.8	23
FLSN 100 LK	1.5	955	15	3.5	0.78	78.3	6.3	41
FLSN 112 M	2.2	960	22	5.2	0.77	80	5.5	45
FLSN 132 S	3	953	30	6.9	0.76	81.9	5.3	71
FLSN 132 M	4	970	40	9	0.78	82.1	6.7	76
FLSN 132 MU	5.5	970	54	12.2	0.79	82.1	7.1	88
FLSN 160 M	7.5	968	74	16	0.8	86	5	100
FLSN 160 L	11	966	109	23	0.81	87	5	128
FLSN 180 L	15	974	147	30	0.82	89.5	7.1	170
FLSN 200 LA	18.5	975	181	36	0.83	90.7	7	240
FLSN 200 LB	22	973	216	43	0.81	91.5	7	260
FLSN 225 M	30	978	293	59	0.8	92	6	392
FLSN 250 M	37	977	362	73	0.8	92.5	6.2	394
FLSN 280 S	45	971	440	84	0.84	93	6	455
FLSN 280 M	55	977	538	109	0.79	93	6.9	532
FLSN 315 ST	75	987	731	133	0.86	94.8	6.5	850
FLSN 315 M	90	987	875	161	0.85	95.6	6.7	1000
FLSN 315 LA	110	983	1067	199	0.85	94.5	6	1050
FLSN 315 LB	132	988	1280	241	0.83	95.9	7.4	1125
FLSN 315 LB	150	986	1454	277	0.82	95.8	6.6	1125
FLSN 355 LA	185	987	1783	346	0.81	95.8	7.5	1415
FLSN 355 LB	220	988	2129	412	0.81	95.6	7.4	1535
FLSN 355 LD	250	993	2406	459	0.82	95.8	7.8	1935
FLSN 355 LD	300	992	2885	558	0.82	95.2	6.8	1935

FLSN

Atmospheres containing explosive GAS



totally enclosed three-phase asynchronous motors

Selection

**CATEGORY 3
ZONE 2**

IP 55 - 50 Hz - Class F - Δ T 80 K - 230 V Δ / 400 V Y or 400 V Δ - S1
 II - 3G - EEx nA II T3

**6
poles
1000 min⁻¹**

A

Type	Rated power at 50 Hz P_N kW	IM 1001 (IM B3)		IM 3001 (IM B5)		IM 2001 (IM B35)		IM 3601 (IM B14)		IM 2101 (IM B34)	
		Code	Qty	Code	Qty	Code	Qty	Code	Qty	Code	Qty
FLSN 80 L	0.25		-		-		-		-		-
FLSN 80 L	0.37		-		-		-		-		-
FLSN 80 L	0.55		-		-		-		-		-
FLSN 90 S	0.75		-		-		-		-		-
FLSN 90 L	1.1		-		-		-		-		-
FLSN 100 LK	1.5		-		-		-		-		-
FLSN 112 M	2.2		-		-		-		-		-
FLSN 132 S	3		-		-		-		-		-
FLSN 132 M	4		-		-		-		-		-
FLSN 132 MU	5.5		-		-		-		-		-
FLSN 160 M	7.5		-		-		-		-		-
FLSN 160 L	11		-		-		-		-		-
FLSN 180 L	15		-		-		-		-		-
FLSN 200 LA	18.5		-		-		-		-		-
FLSN 200 LB	22		-		-		-		-		-
FLSN 225 M	30		-		-		-		-		-
FLSN 250 M	37		-		-		-		-		-
FLSN 280 S	45		-		-		-		-		-
FLSN 280 M	55		-		-		-		-		-
FLSN 315 ST	75		-		-		-		-		-
FLSN 315 M	90		-		-		-		-		-
FLSN 315 LA	110		-		-		-		-		-
FLSN 315 LB	132		-		-		-		-		-
FLSN 315 LB	150		-		-		-		-		-
FLSN 355 LA	185		-		-		-		-		-
FLSN 355 LB	220		-		-		-		-		-
FLSN 355 LD	250		-		-		-		-		-
FLSN 355 LD	300		-		-		-		-		-

FLSN

Atmospheres containing explosive GAS



totally enclosed three-phase asynchronous motors

Selection

**CATEGORY 3
ZONE 2**

IP 55 - 50 Hz - Class F - Δ T 80 K - 230 V Δ / 400 V Y or 400 V Δ - S1
 II - 3G - EEx nA II T3

**8
poles
750 min⁻¹**

A

Type	Rated power at 50 Hz	Rated speed	Rated moment	Rated current	Power factor	Efficiency	Starting torque / Rated torque	Weight
	P_N kW	N_N min ⁻¹	M_N N.m	I_N (400V) A	cos φ 100 %	η 100 %	I_D / I_N	IM B3 kg
FLSN 80 L	0.18	710	2.5	0.8	0.64	52.3	3	14
FLSN 80 L	0.25	720	3.4	1.1	0.6	54.5	3.2	16
FLSN 90 S	0.37	685	5	1.2	0.71	64	3.5	21
FLSN 90 L	0.55	695	7.5	1.7	0.72	63	3.3	23
FLSN 100 LK	0.75	720	10	2.3	0.68	70.9	4.1	41
FLSN 100 LK	1.1	720	15	3.8	0.62	68	4.1	43
FLSN 112 M	1.5	725	20	4.8	0.63	72.5	4	45
FLSN 132 S	2.2	715	30	7.2	0.6	74	3.2	71
FLSN 132 M	3	705	40	9.1	0.63	76	3.1	81
FLSN 160 MA	4	710	54	11.3	0.63	81.5	3.8	105
FLSN 160 MB	5.5	710	74	15	0.65	82	3.8	111
FLSN 160 L	7.5	715	100	20	0.65	83	3.8	128
FLSN 180 L	11	724	147	27	0.7	85.1	3.9	175
FLSN 200 L	15	729	196	34	0.72	88.1	5	265
FLSN 225 ST	18.5	727	242	41	0.73	89	5	285
FLSN 225 M	22	732	288	48	0.72	92.1	5.9	388
FLSN 250 M	30	729	393	61	0.78	91.2	6.2	393
FLSN 280 S	37	723	487	75	0.78	92	4.5	472
FLSN 280 M	45	730	592	102	0.7	91.7	6	563
FLSN 315 ST	55	738	715	102	0.83	94.2	7.4	850
FLSN 315 M	75	743	972	147	0.78	94.8	7.4	1000
FLSN 315 LA	90	742	1169	177	0.78	94.7	6.7	1030
FLSN 315 LB	110	742	1420	222	0.76	94.8	7.2	1125
FLSN 355 LA	132	741	1704	258	0.78	95.3	6.7	1415
FLSN 355 LB	160	741	2065	312	0.78	95.3	6.9	1535
FLSN 355 LD	200	741	2581	364	0.84	95	6.7	1935

FLSN

Atmospheres containing explosive GAS



totally enclosed three-phase asynchronous motors

Selection

**CATEGORY 3
ZONE 2**

IP 55 - 50 Hz - Class F - ΔT 80 K - 230 V Δ / 400 V Y or 400 V Δ - S1

II - 3G - EEx nA II T3

**8
poles
750 min⁻¹**

A

Type	Rated power at 50 Hz P_N kW	IM 1001 (IM B3)		IM 3001 (IM B5)		IM 2001 (IM B35)		IM 3601 (IM B14)		IM 2101 (IM B34)	
		Code	Qty	Code	Qty	Code	Qty	Code	Qty	Code	Qty
FLSN 80 L	0.18		-		-		-		-		-
FLSN 80 L	0.25		-		-		-		-		-
FLSN 90 S	0.37		-		-		-		-		-
FLSN 90 L	0.55		-		-		-		-		-
FLSN 100 LK	0.75		-		-		-		-		-
FLSN 100 LK	1.1		-		-		-		-		-
FLSN 112 M	1.5		-		-		-		-		-
FLSN 132 S	2.2		-		-		-		-		-
FLSN 132 M	3		-		-		-		-		-
FLSN 160 MA	4		-		-		-		-		-
FLSN 160 MB	5.5		-		-		-		-		-
FLSN 160 L	7.5		-		-		-		-		-
FLSN 180 L	11		-		-		-		-		-
FLSN 200 L	15		-		-		-		-		-
FLSN 225 ST	18.5		-		-		-		-		-
FLSN 225 M	22		-		-		-		-		-
FLSN 250 M	30		-		-		-		-		-
FLSN 280 S	37		-		-		-		-		-
FLSN 280 M	45		-		-		-		-		-
FLSN 315 ST	55		-		-		-		-		-
FLSN 315 M	75		-		-		-		-		-
FLSN 315 LA	90		-		-		-		-		-
FLSN 315 LB	110		-		-		-		-		-
FLSN 355 LA	132		-		-		-		-		-
FLSN 355 LB	160		-		-		-		-		-
FLSN 355 LD	200		-		-		-		-		-

FLSN

Atmospheres containing explosive GAS



totally enclosed three-phase asynchronous motors

**CATEGORY 3
ZONE 2**

Dimensions

Dimensions of the FLSN totally enclosed three-phase asynchronous motors - IP 55
Cage rotor

Dimensions in millimetres

- shaft end

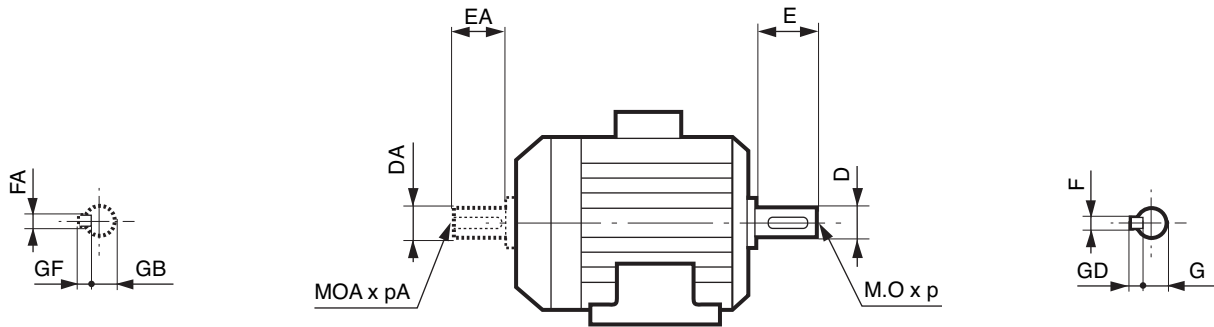

Main dimensions

Type	4, 6 and 8 poles									2 poles								
	F	GD	D	G	E	O	p	L	LO	F	GD	D	G	E	O	p	L	LO
FLSN 80 L	6	6	19j6	15.5	40	6	16	30	6	6	6	19j6	15.5	40	6	16	30	6
FLSN 90 S/L	8	7	24j6	20	50	8	19	40	6	8	7	24j6	20	50	8	19	40	6
FLSN 100 LK	8	7	28j6	24	60	10	22	50	6	8	7	28j6	24	60	10	22	50	6
FLSN 112 M/MR	8	7	28j6	24	60	10	22	50	6	8	7	28j6	24	60	10	22	50	6
FLSN 132 S/M/MR	10	8	38k6	33	80	12	28	63	10	10	8	38k6	33	80	12	28	63	10
FLSN 160 M/L	12	8	42k6	37	110	16	36	-	-	12	8	42k6	37	110	16	36	-	-
FLSN 180 MR/L	14	9	48k6	42.5	110	16	36	-	-	14	9	48k6	42.5	110	16	36	-	-
FLSN 200 L	16	10	55m6	49	110	20	42	-	-	16	10	55m6	49	110	20	42	-	-
FLSN 225 ST/MT/M	18	11	60m6	53	140	20	42	-	-	16	10	55m6	49	110	20	42	-	-
FLSN 250 M	18	11	65m6	58	140	20	42	-	-	18	11	60m6	53	140	20	42	-	-
FLSN 280 S/M	20	12	75m6	67.5	140	20	42	-	-	18	11	65m6	58	140	20	42	-	-
FLSN 315 ST	22	14	80m6	71	170	20	42	-	-	18	11	65m6	58	140	20	42	-	-
FLSN 315 M	22	14	80m6	71	170	20	42	-	-	18	11	65m6	58	140	20	42	-	-
FLSN 315 L	25	14	90m6	81	170	24	50	-	-	20	12	70m6	62.5	140	20	42	-	-
FLSN 355 L/LK	28	16	100m6	90	210	24	50	-	-	22	14	80m6	71	170	20	42	-	-

Secondary shaft end

Type	4, 6 and 8 poles									2 poles								
	FA	GF	DA	GB	EA	OA	pA	L'	LO'	FA	GF	DA	GB	EA	OA	pA	L'	LO'
FLSN 80 L	5	5	14j6	11	30	5	15	25	3.5	5	5	14j6	11	30	5	15	25	3.5
FLSN 90 S/L	6	6	19j6	15.5	40	6	16	30	6	6	6	19j6	15.5	40	6	16	30	6
FLSN 100 LK	8	7	24j6	20	50	8	19	40	6	8	7	24j6	20	50	8	19	40	6
FLSN 112 M/MR	8	7	24j6	20	50	8	19	40	6	8	7	24j6	20	50	8	19	40	6
FLSN 132 S/M/MR	8	7	28j6	24	60	10	22	50	6	8	7	28j6	24	60	10	22	50	6
FLSN 160 M/L	12	8	42k6	37	110	16	36	-	-	12	8	42k6	37	110	16	36	-	-
FLSN 180 MR/L	14	9	48k6	42.5	110	16	36	-	-	14	9	48k6	42.5	110	16	36	-	-
FLSN 200 L	16	10	55m6	49	110	20	42	-	-	16	10	55m6	49	110	20	42	-	-
FLSN 225 ST/MT/M	18	11	60m6	53	140	20	42	-	-	16	10	55m6	49	110	20	42	-	-
FLSN 250 M	18	11	60m6	53	140	20	42	-	-	18	11	60m6	53	140	20	42	-	-
FLSN 280 S/M	20	12	60m6	53	140	20	42	-	-	18	11	60m6	53	140	20	42	-	-
FLSN 315 ST	22	14	80m6	71	170	20	42	-	-	18	11	65m6	58	140	20	42	-	-
FLSN 315 M	22	14	80m6	71	170	20	42	-	-	18	11	65m6	58	140	20	42	-	-
FLSN 315 L	25	14	90m6	81	170	24	50	-	-	20	12	70m6	62.5	140	20	42	-	-
FLSN 355 L/LK	28	16	100m6	90	210	24	50	-	-	22	14	80m6	71	170	20	42	-	-

FLSN

Atmospheres containing explosive GAS



totally enclosed three-phase asynchronous motors

**CATEGORY 3
ZONE 2**

Dimensions

Dimensions of the FLSN totally enclosed three-phase asynchronous motors - IP 55
Cage rotor

Dimensions in millimetres

– foot mounted

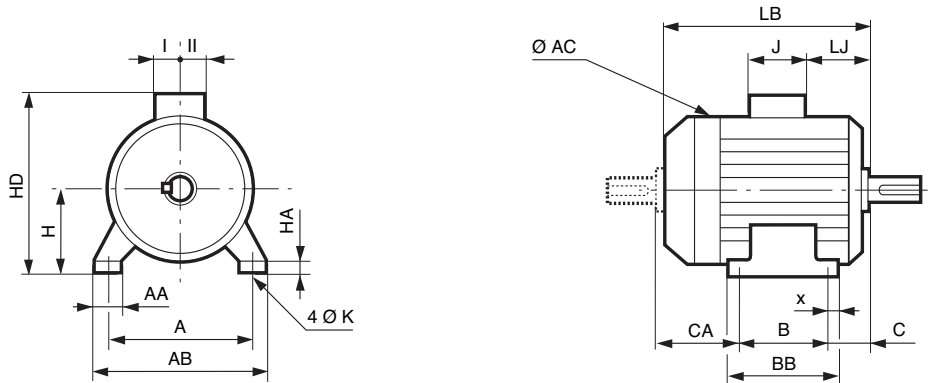

Type	Main dimensions																		
	A	AB	B	BB	C	x	AA	K	HA	H	AC	HD	LB	LB1 ¹	LJ	J	I	II	CA
FLSN 80 L	125	157	100	130	50	20	32	9	10	80	160	222	214	178	33	114	57	57	68
FLSN 90 S	140	172	100	160	56	22	34	9	11	90	185	247	243	204	28	114	57	57	93
FLSN 90 L	140	172	125	160	56	22	34	9	11	90	185	247	243	204	28	114	57	57	68
FLSN 100 LK	160	200	140	174	63	22	42	12	12	100	226	276	323	276	55	114	57	57	125
FLSN 112 M	190	230	140	174	70	22	45	12	12	112	226	288	323	276	55	114	57	57	119
FLSN 132 S	216	255	140	223	89	31	58	12	15	132	264	323	387	328	46	114	57	57	164
FLSN 132 M	216	255	178	223	89	31	58	12	15	132	264	323	387	328	46	114	57	57	126
FLSN 132 MU	216	255	178	223	89	31	58	12	15	132	264	323	410	352	46	114	57	57	149
FLSN 160 M	254	294	210	294	108	20	65	14	20	160	310	385	495	435	50	160	80	80	182
FLSN 160 L	254	294	254	294	108	20	65	14	20	160	310	385	495	435	50	160	80	80	138
FLSN 180 MR	279	324	241	295	121	25	80	14	25	180	310	405	515	450	50	160	80	80	158
FLSN 180 L	279	330	279	335	121	28	70	14	28	180	350	468	555	480	55	220	128	128	160
FLSN 200 L	318	374	305	361	133	28	80	18	44	200	394	515	681	595	65	220	128	128	248
FLSN 225 ST	356	420	286	367	149	28	100	18	35	225	394	540	681	595	65	220	128	128	251
FLSN 225 MT	356	420	311	367	149	28	100	18	35	225	394	540	681	595	65	220	128	128	226
FLSN 225 M	356	426	311	375	149	32	80	18	27	225	540	656	780	630	70	352	173	210	326
FLSN 250 M	406	476	349	413	168	32	80	22	27	250	540	681	780	630	70	352	173	210	269
FLSN 280 S	457	527	368	432	190	32	80	22	27	280	540	711	860	710	70	352	173	210	302
FLSN 280 M	457	527	419	483	190	32	80	22	27	280	540	711	960	810	70	352	173	210	357
FLSN 315 ST	508	598	406	547	216	45	90	27	45	315	556	761	1068	910	68	352	173	210	452
FLSN 315 M	508	600	457	598	216	45	100	27	45	315	624	835	1203	1030	70	452	217	269	536
FLSN 315 L	508	600	508	598	216	45	100	27	45	315	632	835	1203	1030	70	452	217	269	485
FLSN 355 LA/LB	610	710	630	710	254	40	110	27	35	355	700	910	1305	1118	61	452	217	269	427
FLSN 355 LC/LD	610	710	630	710	254	40	110	27	35	355	700	910	1430	1242	61	452	217	269	552
FLSN 355 LK	610	750	630	815	254	40	128	27	45	355	787	1117	1687	1430	52	700	224	396	813

1. LB1 : non ventilated motor.

FLSN

Atmospheres containing explosive GAS



totally enclosed three-phase asynchronous motors

**CATEGORY 3
ZONE 2**

Dimensions

Dimensions of the FLSN totally enclosed three-phase asynchronous motors - IP 55
Cage rotor

Dimensions in millimetres

– (FF) foot and plain hole flange mounted

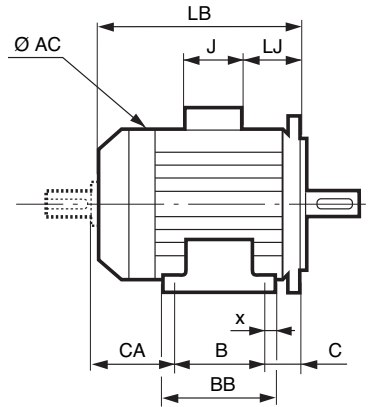
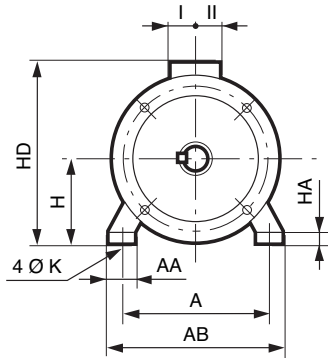

Type	Main dimensions																		
	A	AB	B	BB	C	x	AA	K	HA	H	AC	HD	LB	LB1'	LJ	J	I	II	Sym.
FLSN 80 L	125	157	100	130	50	20	32	9	10	80	160	222	214	178	33	114	57	57	FF 165
FLSN 90 S	140	172	100	160	76	22	34	9	11	90	185	247	263	224	48	114	57	57	FF 165
FLSN 90 L	140	172	125	160	76	22	34	9	11	90	185	247	263	224	48	114	57	57	FF 165
FLSN 100 LK	160	200	140	174	63	22	42	12	12	100	226	276	323	276	55	114	57	57	FF 215
FLSN 112 M	190	230	140	174	70	22	45	12	12	112	226	288	323	276	55	114	57	57	FF 215
FLSN 132 S	216	255	140	223	89	31	58	12	15	132	264	323	387	328	46	114	57	57	FF 265
FLSN 132 M	216	255	178	223	89	31	58	12	15	132	264	323	387	328	46	114	57	57	FF 265
FLSN 132 MU	216	255	178	223	89	31	58	12	15	132	264	323	410	352	46	114	57	57	FF 265
FLSN 160 M	254	294	210	294	108	20	65	14	20	160	310	385	495	435	50	160	80	80	FF 300
FLSN 160 L	254	294	254	294	108	20	65	14	20	160	310	385	495	435	50	160	80	80	FF 300
FLSN 180 MR	279	324	241	295	121	25	80	14	25	180	310	405	515	450	50	160	80	80	FF 300
FLSN 180 L	279	330	279	335	121	28	70	14	28	180	350	468	555	480	55	220	128	128	FF 300
FLSN 200 L	318	374	305	361	133	28	80	18	44	200	394	515	681	595	65	220	128	128	FF 350
FLSN 225 ST	356	420	286	367	149	28	100	18	35	225	394	540	681	595	65	220	128	128	FF 400
FLSN 225 MT	356	420	311	367	149	28	100	18	35	225	394	540	681	595	65	220	128	128	FF 400
FLSN 225 M	356	426	311	375	149	32	80	18	27	225	540	656	780	630	70	352	173	210	FF 400
FLSN 250 M	406	476	349	413	168	32	80	22	27	250	540	681	780	630	70	352	173	210	FF 500
FLSN 280 S	457	527	368	432	190	32	80	22	27	280	540	711	860	710	70	352	173	210	FF 500
FLSN 280 M	457	527	419	483	190	32	80	22	27	280	540	711	960	810	70	352	173	210	FF 500
FLSN 315 ST	508	598	406	547	216	45	90	27	45	315	556	761	1068	910	68	352	173	210	FF 600
FLSN 315 M	508	600	457	598	216	45	100	27	45	315	624	835	1203	1030	70	452	217	269	FF 600
FLSN 315 L	508	600	508	598	216	45	100	27	45	315	632	835	1203	1030	70	452	217	269	FF 600
FLSN 355 LA/LB	610	710	630	710	254	40	110	27	35	355	700	910	1305	1118	61	452	217	269	FF 740
FLSN 355 LC/LD	610	710	630	710	254	40	110	27	35	355	700	910	1430	1242	61	452	217	269	FF 740
FLSN 355 LK	610	750	630	815	254	40	128	27	45	355	787	1117	1687	1430	52	700	224	396	FF 740

1. LB1' : non ventilated motor.

CA dimension and shaft end dimensions identical to those of the foot mounted motors.

FLSN

Atmospheres containing explosive GAS



totally enclosed three-phase asynchronous motors

**CATEGORY 3
ZONE 2**

Dimensions

Dimensions of the FLSN totally enclosed three-phase asynchronous motors - IP 55
Cage rotor

Dimensions in millimetres

– (FF) plain hole flange mounted

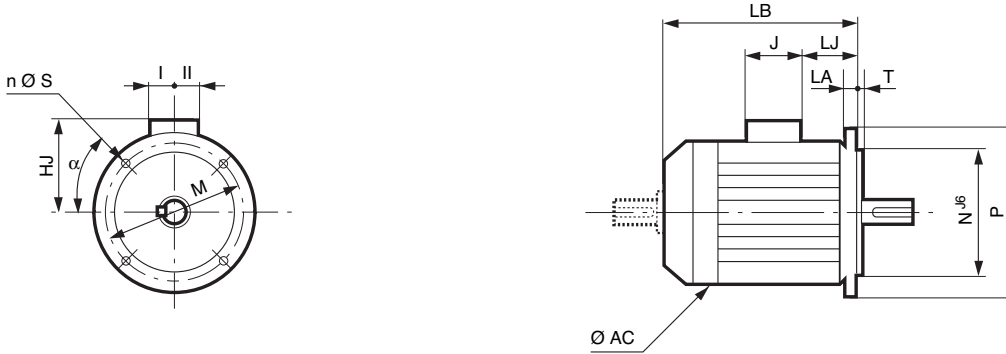

IEC symbol	Flange dimensions						
	M	N	P	T	n	S	LA
FF 165	165	130	200	3.5	4	12	10
FF 165	165	130	200	3.5	4	12	10
FF 165	165	130	200	3.5	4	12	10
FF 215	215	180	250	4	4	15	12
FF 215	215	180	250	4	4	15	12
FF 265	265	230	300	4	4	14.5	14
FF 265	265	230	300	4	4	14.5	14
FF 265	265	230	300	4	4	14.5	14
FF 300	300	250	350	5	4	18.5	15
FF 300	300	250	350	5	4	18.5	15
FF 300	300	250	350	5	4	18.5	15
FF 300	300	250	350	5	4	18.5	15
FF 350	350	300	400	5	4	18	15
FF 400	400	350	450	5	8	18	16
FF 400	400	350	450	5	8	18	16
FF 400	400	350	450	5	8	18	16
FF 500	500	450	550	5	8	18	18
FF 500	500	450	550	5	8	18	18
FF 500	500	450	550	5	8	18	18
FF 600	600	550	660	6	8	22	25
FF 600	600	550	660	6	8	22	25
FF 600	600	550	660	6	8	22	25
FF 740	740	680	800	6	8	22	25
FF 740	740	680	800	6	8	22	25
FF 740	740	680	800	6	8	22	25

Type	Main dimensions							
	AC	LB	LB1 ¹	HJ	LJ	J	I	II
FLSN 80 L	160	214	178	142	33	114	57	57
FLSN 90 S	185	263	224	153	48	114	57	57
FLSN 90 L	185	263	224	153	48	114	57	57
FLSN 100 LK	226	323	276	176	55	114	57	57
FLSN 112 M	226	323	276	176	55	114	57	57
FLSN 132 S	264	387	328	195	46	114	57	57
FLSN 132 M	264	387	328	195	46	114	57	57
FLSN 132 MU	264	410	352	195	46	114	57	57
FLSN 160 M	310	495	435	225	50	160	80	80
FLSN 160 L	310	495	435	225	50	160	80	80
FLSN 180 MR	310	515	450	225	50	160	80	80
FLSN 180 L	350	555	480	280	55	220	128	128
FLSN 200 L	394	681	595	315	65	220	128	128
FLSN 225 ST	394	681	595	315	65	220	128	128
FLSN 225 MT	394	681	595	315	65	220	128	128
FLSN 225 M	540	780	630	431	70	352	173	210
FLSN 250 M	540	780	630	431	70	352	173	210
FLSN 280 S	540	860	710	431	70	352	173	210
FLSN 280 M	540	960	810	431	70	352	173	210
FLSN 315 ST	556	1068	910	446	68	352	173	210
FLSN 315 M	624	1203	1030	520	70	452	217	269
FLSN 315 L	632	1203	1030	520	70	452	217	269
FLSN 355 LA/LB	700	1305	1118	555	61	452	217	269
FLSN 355 LC/LD	700	1305	1242	555	61	452	217	269
FLSN 355 LK	787	1687	1430	762	52	700	224	396

1. LB1 : non ventilated motor.
FF flange mounted motors, in position IM 3001 (IM B5), are only available up to frame size 225.

FLSN

Atmospheres containing explosive GAS



totally enclosed three-phase asynchronous motors

**CATEGORY 3
ZONE 2**

Dimensions

Dimensions of the FLSN totally enclosed three-phase asynchronous motors - IP 55
Cage rotor

Dimensions in millimetres

– (FT) foot and tapped hole flange mounted

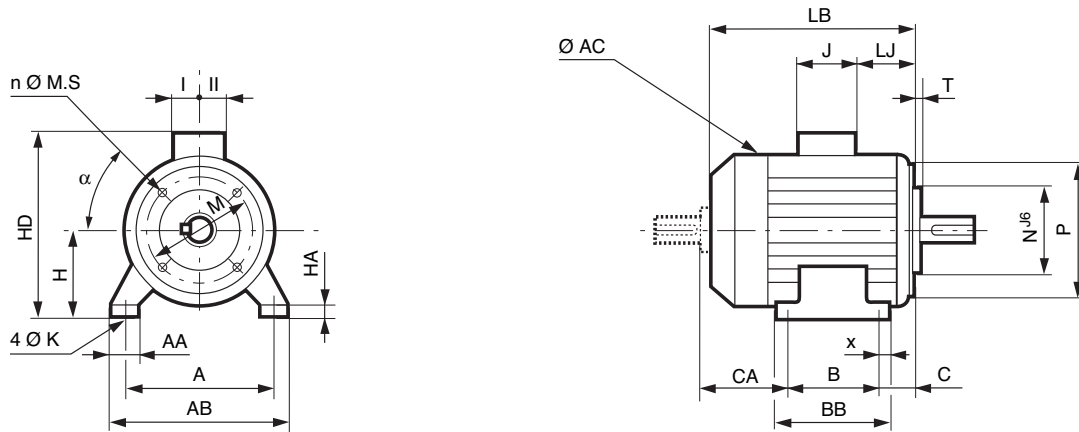

Type	Main dimensions																		Sym.
	A	AB	B	BB	C	x	AA	K	HA	H	AC	HD	LB	LJ	J	I	II	CA	
FLSN 80 L	125	157	100	130	50	20	32	9	10	80	160	222	214	33	114	57	57	68	FT 100
FLSN 90 S	140	172	100	160	56	22	34	10	11	90	185	247	243	28	114	57	57	93	FT 115
FLSN 90 L	140	172	125	160	56	22	34	10	11	90	185	247	243	28	114	57	57	68	FT 115
FLSN 100 LK	160	200	140	174	63	22	42	12	12	100	226	276	323	55	114	57	57	125	FT 130
FLSN 112 M	190	230	140	174	70	22	45	12	12	112	226	288	323	55	114	57	57	119	FT 130
FLSN 112 MR	190	230	140	174	70	22	45	12	12	112	226	288	345	28	114	57	57	142	FT 130
FLSN 132 M	216	255	178	223	89	31	58	12	15	132	264	323	387	46	114	57	57	126	FT 215
FLSN 132 MR	216	255	178	223	89	31	58	12	15	132	264	323	387	46	114	57	57	126	FT 215

CA dimension and shaft end dimensions identical to those of the foot mounted motors.

FLSN

Atmospheres containing explosive GAS



totally enclosed three-phase asynchronous motors

**CATEGORY 3
ZONE 2**

Dimensions

Dimensions of the FLSN totally enclosed three-phase asynchronous motors - IP 55
Cage rotor

Dimensions in millimetres

– (FT) tapped hole flange mounted

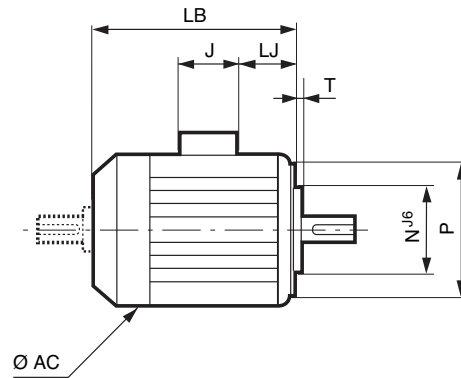
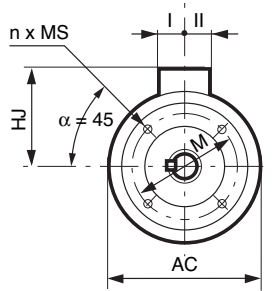

IEC symbol	Flange dimensions					
	M	N	P	T	n	MS
FT 100	100	80	120	3	4	M6
FT 115	115	95	140	3	4	M8
FT 115	115	95	140	3	4	M8
FT 130	130	110	160	3.5	4	M8
FT 130	130	110	160	3.5	4	M8
FT 215	215	180	250	4	4	M12
FT 215	215	180	250	4	4	M12
FT 215	215	180	250	4	4	M12

Type	Main dimensions						
	AC	LB	HJ	LJ	J	I	II
FLSN 80L	160	214	150	22	126	63	63
FLSN 90 L	185	243	160	22	126	63	63
FLSN 90 S	185	243	160	22	126	63	63
FLSN 100 LK	226	323	193	37	150	75	75
FLSN 112 M	226	323	176	37	150	75	75
FLSN 132 M	264	387	213	28	150	75	75
FLSN 132 MU	264	387	213	28	150	75	75
FLSN 132 S	264	387	213	28	150	75	75

Shaft end dimensions identical to those of the foot mounted motors.

