

LSA 40

Low Voltage Alternator - 4 pole

10 to 20 kVA - 50 Hz / 12.5 to 25 kVA - 60 Hz
Electrical and mechanical data

LEROY-SOMER[™]

Nidec
All for dreams

The best of performance

Nidec Leroy-Somer LSA 40 alternator has been designed to offer you the best power generation performances. With its meticulous design and optimized architecture, the LSA 40 strikes the perfect balance between compactness, reliability, performance and longevity.

Whatever your application, the LSA 40 will meet your needs and will adapt to all situations.

Standards

Nidec Leroy-Somer LSA 40 alternator meets all key international standards and regulations, including IEC 60034, NEMA MG 1.32-33, ISO 8528-3, CSA C22.2 n°100-14 and UL 1446 (UL 1004 on request). Also compliant with IEC 61000-6-2, IEC 61000-6-3, IEC 61000-6-4, VDE 0875G, VDE 0875N and EN 55011, group 1 class A for European zone. Nidec Leroy-Somer LSA 40 alternator can be integrated in EC marked generator set, and bears EC, UKCA and CMIM markings. It is designed, manufactured and marketed in an ISO 9001 and ISO 14001 quality assurance environment.

Electrical characteristics and performances

- Class H insulation
- 2/3 pitch winding, standard 12-wire (6) reconnectable
- Voltage range:
 - 50 Hz: 220V - 240V and 380V - 415V (440V)
 - 60 Hz: 208V - 240V and 380V - 480V
- High efficiency and motor starting capacity
- Other voltages are possible with optional adapted windings:
 - 50 Hz: 440V (no. 7), 500V (no. 9)
 - 60 Hz: 380V and 416V (no. 8), 600V (no. 9)

Excitation and regulation system

Excitation system			Regulation options		
AVR	SHUNT	AREP (option)	C.T. Current transformer for paralleling	Mains paralleling	Remote voltage potentiometer
R220	Standard				
D350	Option	Standard	√*		√
D550**	Option	Option	√*	√	√

*: only with AREP **: external mounting

3-phase sensing is included as a standard with digital regulators.

Protection system and options

- The LSA 40 is IP 23
- Complete winding protection for clean environments with relative humidity ≤ 95 %, including indoor marine environments
- Options:
 - Filters on air inlet: derating 5%
 - Filters on air inlet and air outlet (IP 44): derating 10%
 - Reinforced winding protection for harsh environments and relative humidity greater than 95%
 - Space heater
 - Thermal protection for stator windings
 - Shaft height: H = 180 mm (to be specified when ordering)

Mechanical construction

- Compact and rigid assembly to better withstand generator vibrations
- Steel frame and terminal box
- Aluminum flanges and shields
- Two-bearing and single-bearing versions designed to be suitable for commercially-available heat engines
- Half-key balancing
- Greased for life bearings (20 000h)
- Direction of rotation: clockwise and anti-clockwise (without derating)

Terminal box design

- Easy access to the voltage regulator and to the connections
- 8-way terminal block for reconnecting the voltage
- Predrilled holes for cable gland



LSA 40 - 10 to 20 kVA - 50 Hz / 12.5 to 25 kVA - 60 Hz

General characteristics

Insulation class	H	Excitation system	SHUNT	AREP
Winding pitch	2/3 (wind. 6)	AVR type	R220	D350
Number of wires	12	Voltage regulation (*)	± 0.5%	± 0.25%
Protection	IP 23	Short-circuit current	-	300% (3 IN): 10 s
Altitude	≤ 1000 m	Total Harmonic Distortion THD (**) in no-load	< 3%	
Overspeed	2250 R.P.M.	Total Harmonic Distortion THD (**) on linear load	< 5%	
Air flow	0.06 m ³ /s (50 Hz) - 0.072 m ³ /s (60 Hz)	Waveform: NEMA = TIF (**)	< 50	

(*) Steady state (**) Total harmonic distortion between phases, in no-load or on linear load

Ratings 50 Hz - 1500 R.P.M.

kVA / kW - P.F. = 0.8																				
Duty/T°C	Continuous duty/40°C					Continuous duty/40°C					Stand-by/40°C					Stand-by/27°C				
Class/T°K	H/125°K					F/105°K					H/150°K					H/163°K				
Phase	3 ph.			1 ph.		3 ph.			1 ph.		3 ph.			1 ph.		3 ph.			1 ph.	
Y	380V	400V	415V	440V	ΔΔ	380V	400V	415V	440V	ΔΔ	380V	400V	415V	440V	ΔΔ	380V	400V	415V	440V	ΔΔ
Δ	220V	230V	240V		230V	220V	230V	240V		230V	220V	230V	240V		230V	220V	230V	240V		230V
YY		200V		220V			200V		220V			200V		220V			200V		220V	
LSA 40 VS1 kVA	10	10	10	9	7	9	9	9	8	6.5	10.5	10.5	10.5	9.5	7.5	11	11	11	10	8
kW	8	8	8	7	5.5	7	7	7	6.5	5	8.5	8.5	8.5	7.5	6	9	9	9	8	6.5
LSA 40 VS2 kVA	12.5	12.5	12.5	11	9	11.5	11.5	11.5	10	8	13.5	13.5	13.5	12	9.5	14	14	14	12.5	10
kW	10	10	10	9	7	9	9	9	8	6.5	11	11	11	9.5	7.5	11	11	11	10	8
LSA 40 S3 kVA	15	15	15	13	10.5	14	14	14	12	10	16	16	16	14	11.5	16.5	16.5	16.5	15	12
kW	12	12	12	10.5	8.5	11	11	11	9.5	8	13	13	13	11	9	13	13	13	12	9.5
LSA 40 S4 kVA	17.5	17.5	17.5	16	12.5	16	16	16	14.5	11.5	19	19	19	17	13.5	19.5	19.5	19.5	17.5	14
kW	14	14	14	13	10	13	13	13	11.5	9	15	15	15	13.5	11	15.5	15.5	15.5	14	11
LSA 40 M5 kVA	20	20	20	18	14	18.5	18.5	18.5	16.5	13	21.5	21.5	21.5	19	15	22	22	22	20	15.5
kW	16	16	16	14.5	11	15	15	15	13	10.5	17	17	17	15	12	17.5	17.5	17.5	16	12.5

Ratings 60 Hz - 1800 R.P.M.

kVA / kW - P.F. = 0.8																				
Duty/T°C	Continuous duty/40°C					Continuous duty/40°C					Stand-by/40°C					Stand-by/27°C				
Class/T°K	H/125°K					F/105°K					H/150°K					H/163°K				
Phase	3 ph.			1 ph.		3 ph.			1 ph.		3 ph.			1 ph.		3 ph.			1 ph.	
Y	380V	416V	440V	480V	ΔΔ	380V	416V	440V	480V	ΔΔ	380V	416V	440V	480V	ΔΔ	380V	416V	440V	480V	ΔΔ
Δ	220V	240V			240V	220V	240V			240V	220V	240V			240V	220V	240V			240V
YY		208V	220V	240V			208V	220V	240V			208V	220V	240V			208V	220V	240V	
LSA 40 VS1 kVA	10	11	11.5	12.5	9	9.5	10.5	10.5	11.5	8.5	11	11.5	12.5	13.5	9.5	11.5	12	13	14	10
kW	8	9	9	10	7	7.5	8.5	8.5	9	7	9	9	10	11	7.5	9	9.5	10.5	11	8
LSA 40 VS2 kVA	12.5	13.5	14.5	15.5	11.5	11.5	12.5	13.5	14.5	10.5	13.5	14.5	15.5	16.5	12	14	15	16	17	12.5
kW	10	11	11.5	12.5	9	9	10	11	11.5	8.5	11	11.5	12.5	13	9.5	11	12	13	13.5	10
LSA 40 S3 kVA	15	16.5	17.5	19	13	14	15.5	16.5	17.5	12	16	18	19	20	14	17	18.5	19.5	21	14.5
kW	12	13	14	15	10.5	11	12.5	13	14	9.5	13	14.5	15	16	11	13.5	15	15.5	17	11.5
LSA 40 S4 kVA	17.5	19	20	22	14.5	16.5	18	19	20.5	13	19	20.5	21.5	23.5	15.5	19.5	21	22	24.5	16
kW	14	15	16	17.5	11.5	13	14.5	15	16.5	10.5	15	16.5	17	19	12.5	15.5	17	17.5	19.5	13
LSA 40 M5 kVA	20	22	23	25	16	18.5	20.5	21.5	23	15	21.5	23.5	25	27	17	22	24.5	26	27.5	17.5
kW	16	17.5	18.5	20	13	15	16.5	17	18.5	12	17	19	20	21.5	13.5	17.5	19.5	21	22	14

Efficiencies 400 V - 50 Hz (— P.F.: 0.8) (--- P.F.: 1)

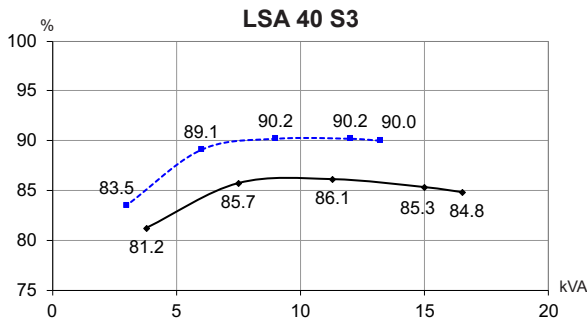
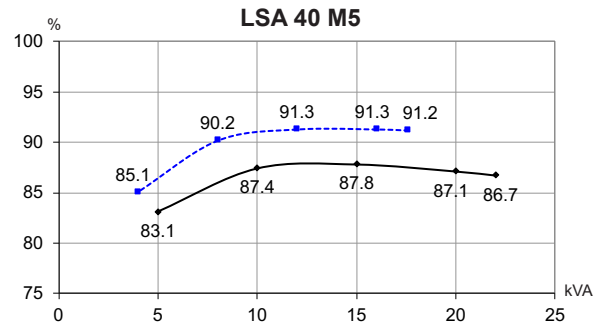
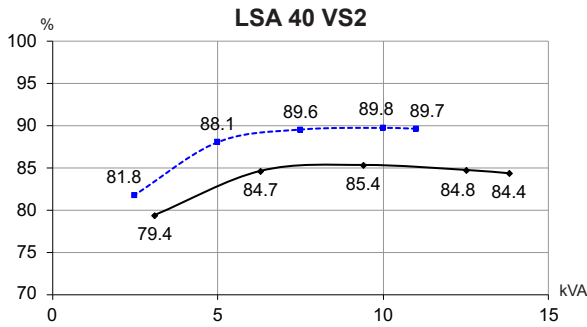
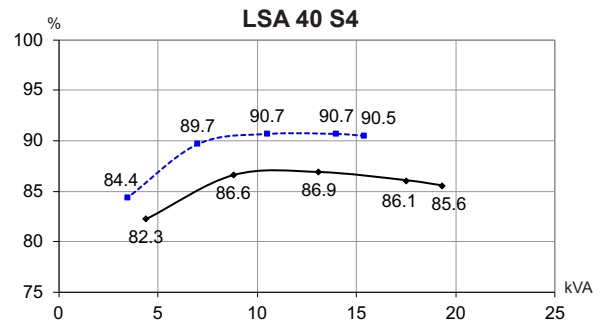
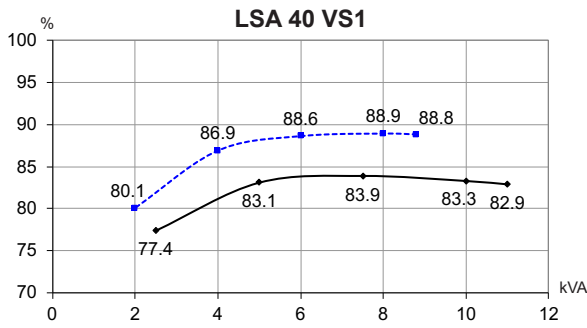

Reactances (%). Time constants (ms) - Class H / 400 V

	VS1	VS2	S3	S4	M5
Kcc Short-circuit ratio	0.7	0.67	0.6	0.6	0.61
Xd Direct-axis synchronous reactance unsaturated	167	174	190	195	193
Xq Quadrature-axis synchronous reactance unsaturated	85	88	97	99	98
T'do No-load transient time constant	719	790	837	878	926
X'd Direct-axis transient reactance saturated	17.2	16.3	16.8	16.4	15.4
T'd Short-circuit transient time constant	74	74	74	74	74
X''d Direct-axis subtransient reactance saturated	8.6	8.1	8.4	8.2	7.7
T''d Subtransient time constant	7	7	7.4	7	7
X''q Quadrature-axis subtransient reactance saturated	16.1	15.9	16.8	16.8	16.2
Xo Zero sequence reactance	0.71	0.68	0.7	0.68	0.64
X2 Negative sequence reactance saturated	12.36	12.04	12.66	12.55	12.01
Ta Armature time constant	11	11	11	11	11

Other class H / 400 V data

	VS1	VS2	S3	S4	M5
io (A) No-load excitation current SHUNT / AREP	0.77 / 1.06	0.78 / 1.06	0.76 / 1.03	0.75 / 1.03	0.72 / 0.98
ic (A) On-load excitation current SHUNT / AREP	1.94 / 2.65	1.97 / 2.69	2.05 / 2.79	2.06 / 2.8	1.95 / 2.66
uc (V) On-load excitation voltage SHUNT / AREP	23.7 / 17.1	24 / 17.3	24.9 / 17.9	24.9 / 18	23.6 / 17
ms Response time ($\Delta U = 20\%$ transient)	500	500	500	500	500
kVA Start ($\Delta U = 20\%$ cont. or $\Delta U = 30\%$ trans.) SHUNT / AREP	24.6	29.9	36.1	43.3	52.7
% Transient ΔU (on-load 4/4) SHUNT / AREP - P.F.: 0.8 _{LAG}	16.1	18.4	17.3	17.1	16.7
W No-load losses	461	514	540	590	645
W Heat dissipation	1597	1784	2063	2255	2352

Transient voltage variation 400V - 50 Hz

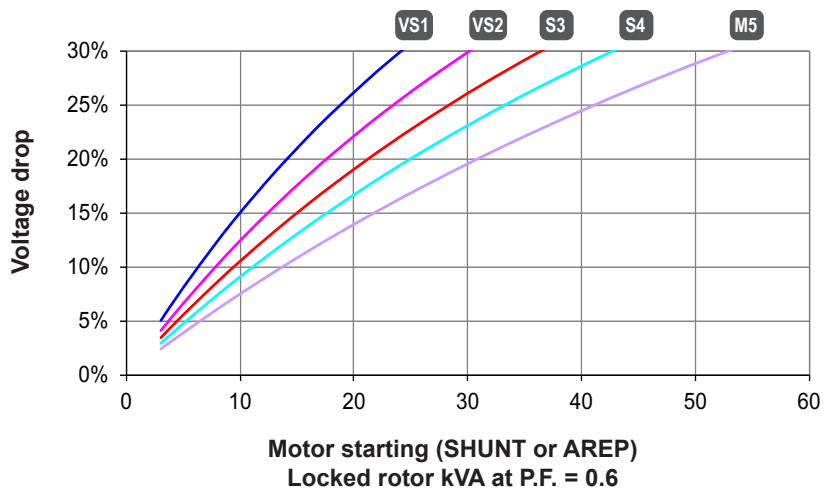
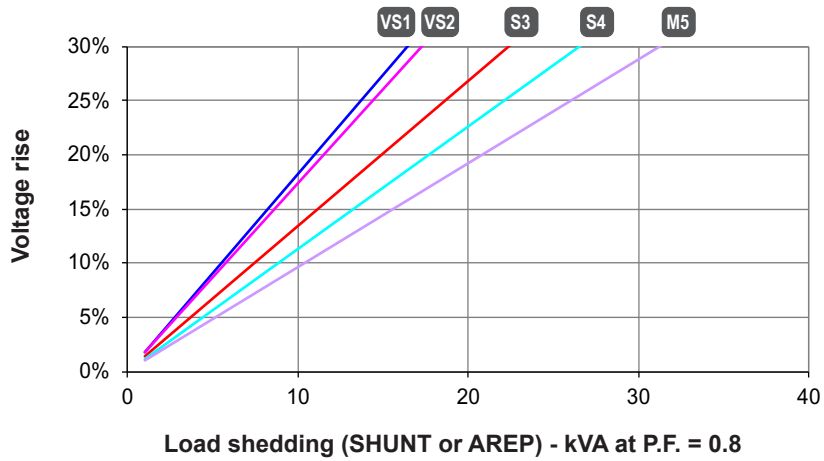
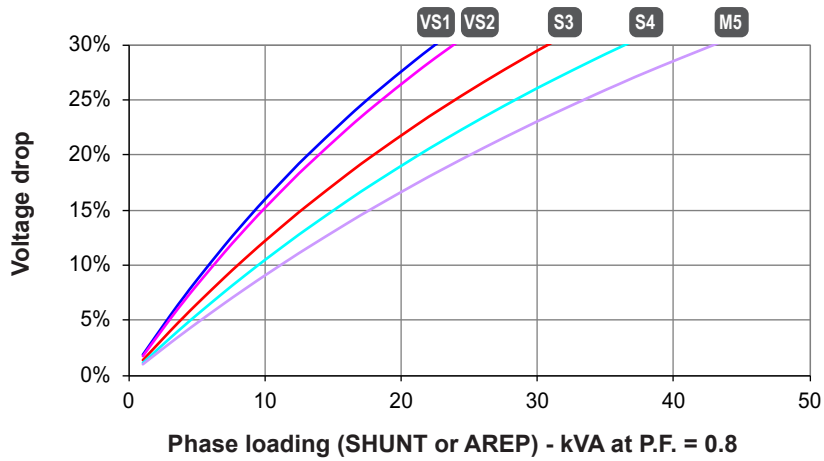

- 1) For a starting P.F. other than 0.6, the starting kVA must be multiplied by $K = \text{Sine P.F.} / 0.8$
- 2) For voltages other than 400V (Y), 230V (Δ) at 50 Hz, then kVA must be multiplied by $(400/U)^2$ or $(230/U)^2$.

Efficiencies 480 V - 60 Hz (— P.F.: 0.8) (--- P.F.: 1)

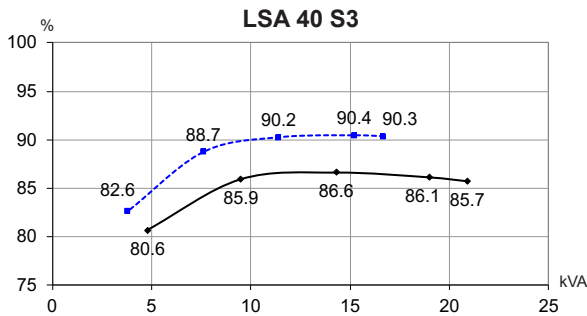
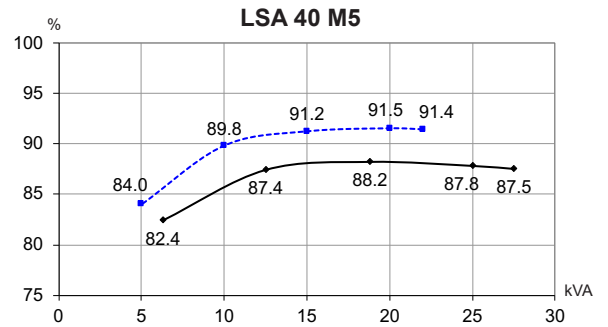
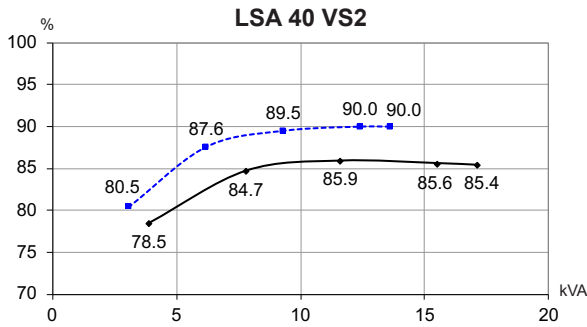
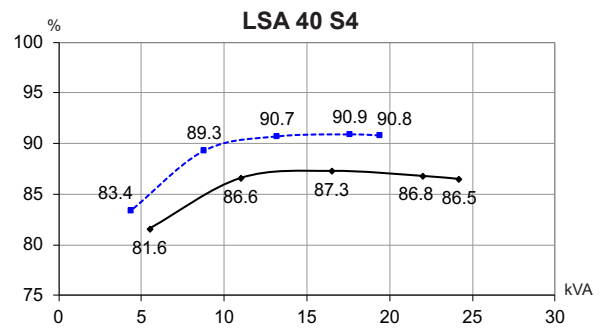
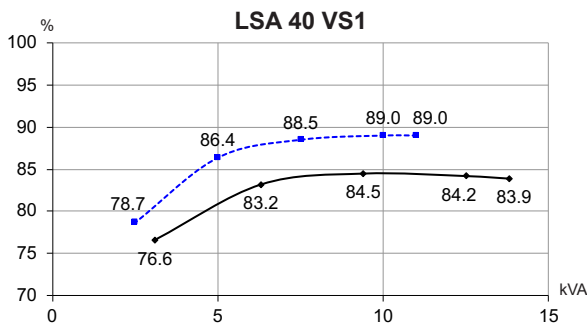

Reactances (%). Time constants (ms) - Class H / 480 V

	VS1	VS2	S3	S4	M5
Kcc Short-circuit ratio	0.67	0.65	0.57	0.57	0.58
Xd Direct-axis synchronous reactance unsaturated	174	180	201	204	201
Xq Quadrature-axis synchronous reactance unsaturated	88	91	102	104	102
T'do No-load transient time constant	719	790	837	878	926
X'd Direct-axis transient reactance saturated	17.9	16.8	17.8	17.2	16.1
T'd Short-circuit transient time constant	74	74	74	74	74
X''d Direct-axis subtransient reactance saturated	8.9	8.4	8.9	8.6	8
T''d Subtransient time constant	7	7	7.4	7	7
X''q Quadrature-axis subtransient reactance saturated	16.7	16.4	17.8	17.6	16.9
Xo Zero sequence reactance	0.74	0.7	0.74	0.71	0.67
X2 Negative sequence reactance saturated	12.87	12.44	13.36	13.15	12.51
Ta Armature time constant	11	11	11	11	11

Other class H / 480 V data

	VS1	VS2	S3	S4	M5
io (A) No-load excitation current SHUNT / AREP	0.77 / 1.06	0.77 / 1.06	0.76 / 1.03	0.75 / 1.02	0.72 / 0.98
ic (A) On-load excitation current SHUNT / AREP	1.97 / 2.69	1.99 / 2.71	2.1 / 2.86	2.1 / 2.86	1.97 / 2.69
uc (V) On-load excitation voltage SHUNT / AREP	24.1 / 17.4	24.3 / 17.5	25.6 / 18.5	25.5 / 18.4	24 / 17.3
ms Response time ($\Delta U = 20\%$ transient)	500	500	500	500	500
kVA Start ($\Delta U = 20\%$ cont. or $\Delta U = 30\%$ trans.) SHUNT / AREP	29.4	35.8	43.3	51.9	63.1
% Transient ΔU (on-load 4/4) SHUNT / AREP - P.F.: 0.8 _{LAG}	16.4	18.7	17.7	17.5	17
W No-load losses	643	717	755	825	904
W Heat dissipation	1866	2069	2447	2654	2763

Transient voltage variation 480V - 60 Hz

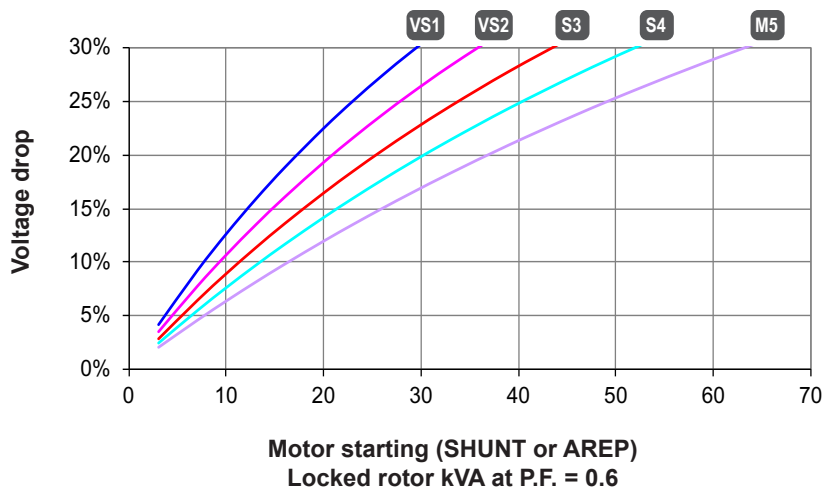
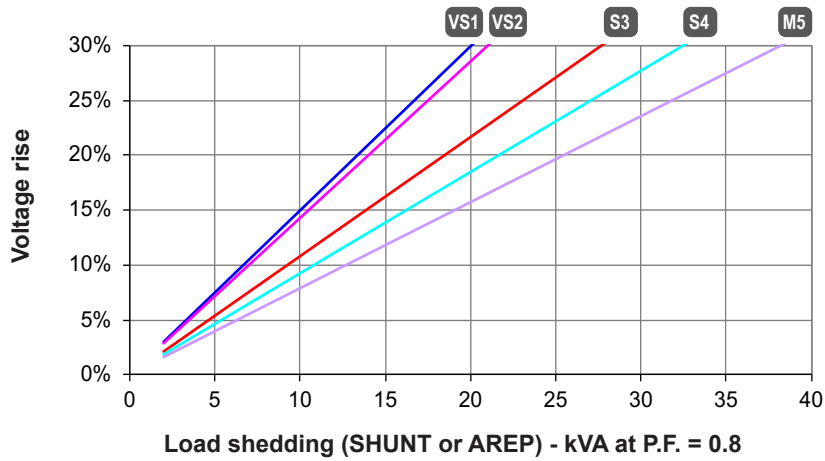
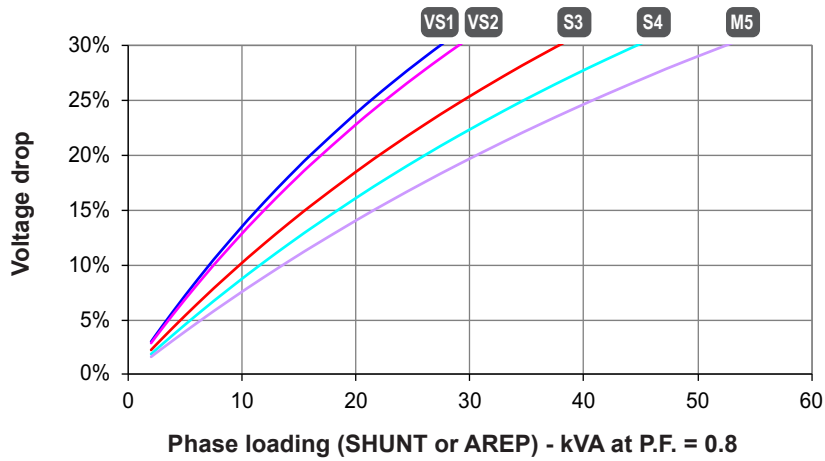

- 1) For a starting P.F. other than 0.6, the starting kVA must be multiplied by $K = \text{Sine P.F.} / 0.8$
- 2) For voltages other than 480V (Y), 277V (Δ), 240V (YY) at 60 Hz, then kVA must be multiplied by $(480/U)^2$ or $(277/U)^2$ or $(240/U)^2$.

3-phase short-circuit curves at no load and rated speed (star connection Y)

LSA 40 VS1

Symmetrical —
Asymmetrical - - -

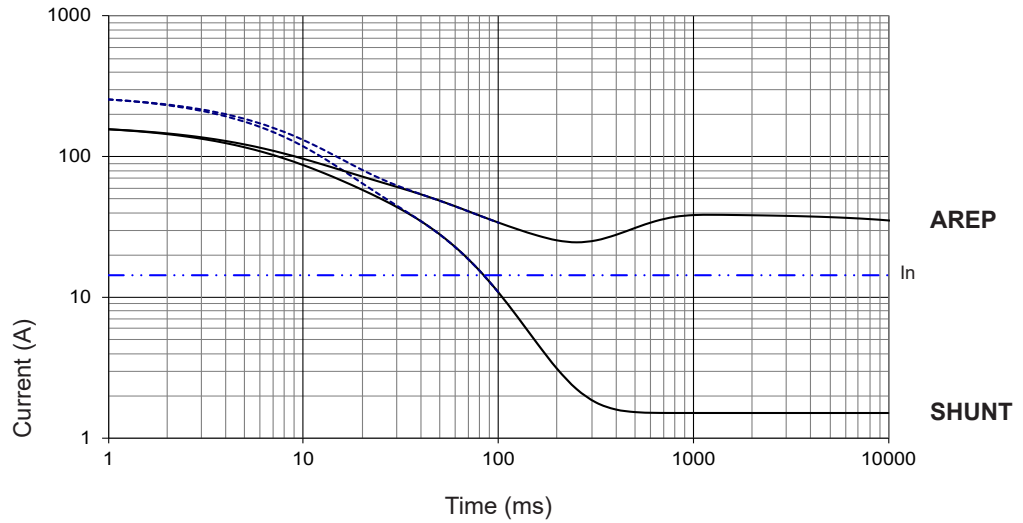

LSA 40 VS2

Symmetrical —
Asymmetrical - - -

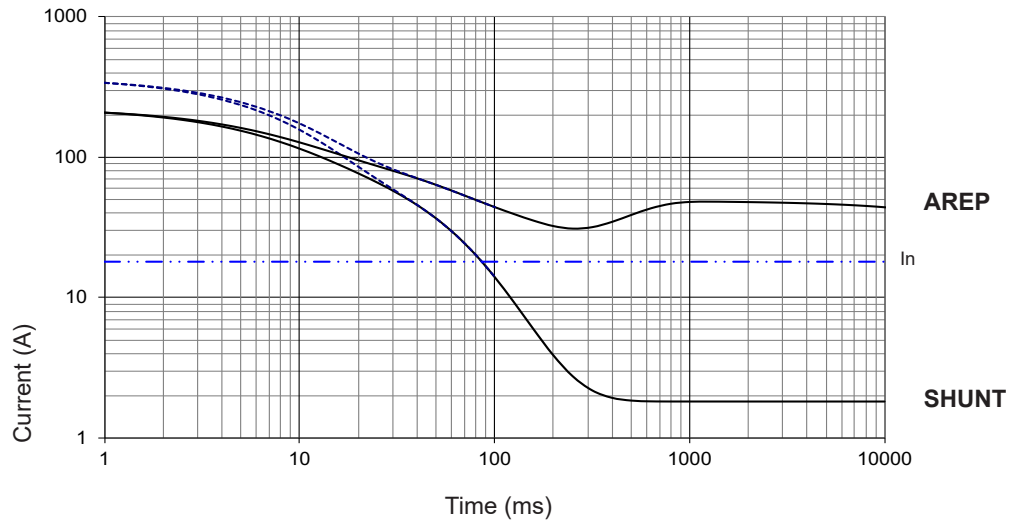

LSA 40 S3

Symmetrical —
Asymmetrical - - -

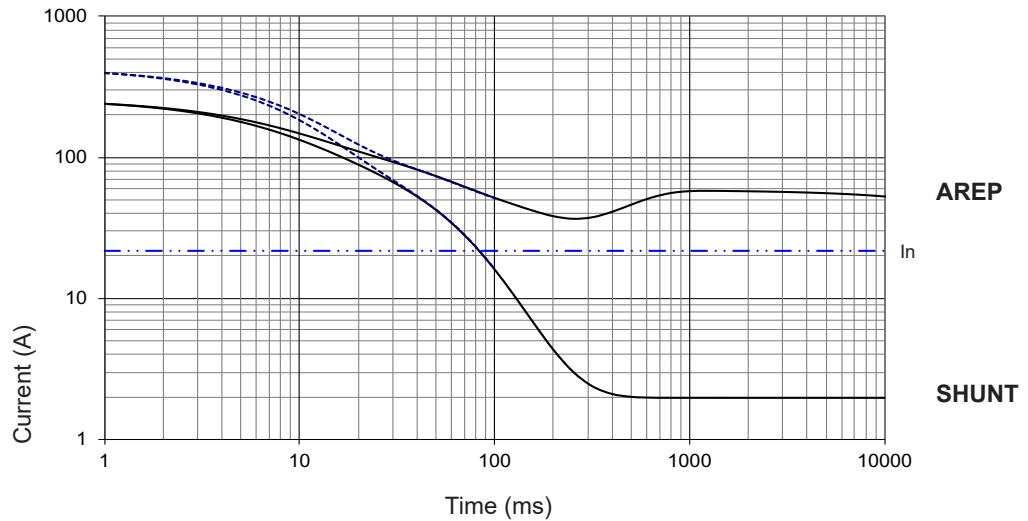

Influence due to connection

Curves shown are for star (Y) connection.

For other connections, use the following multiplication factors:

- Series delta : current value x 1.732 - Parallel star : current value x 2

3-phase short-circuit curves at no load and rated speed (star connection Y)

LSA 40 S4

Symmetrical —
Asymmetrical - - -

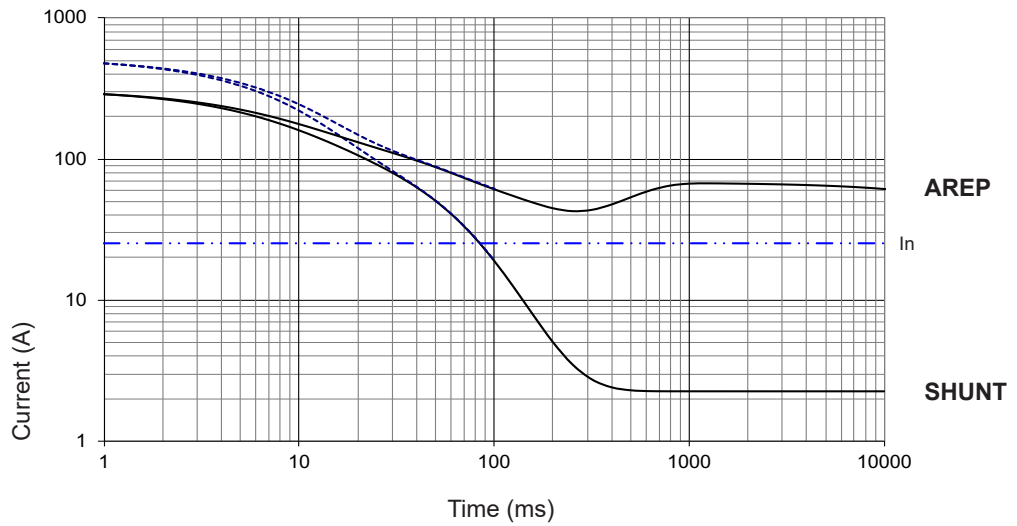

LSA 40 M5

Symmetrical —
Asymmetrical - - -

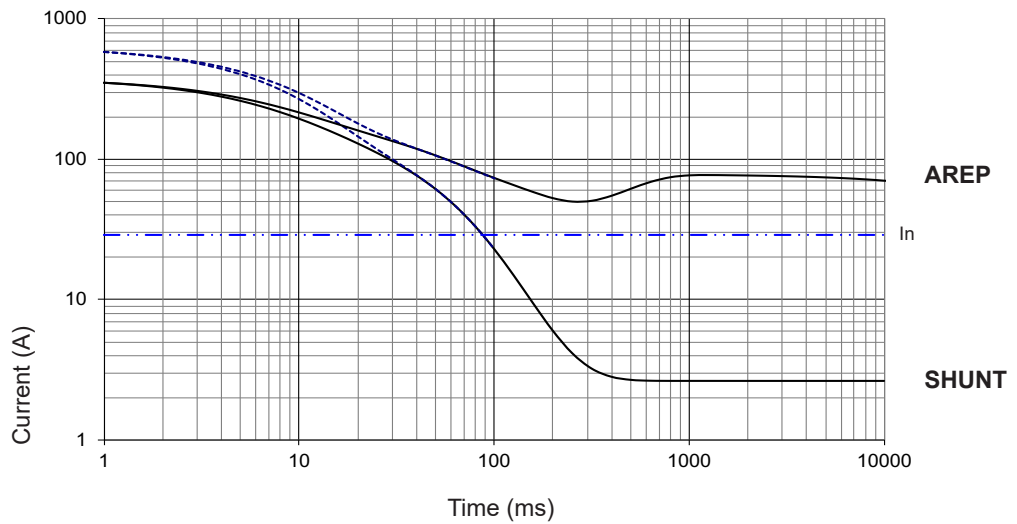

Influence due to short-circuit
Curves are based on a three-phase short-circuit.
For other types of short-circuit, use the following multiplication factors.

	3-phase	2-phase L/L	1-phase L/N
Instantaneous (max.)	1	0.87	1.3
Continuous	1	1.5	2.2
Maximum duration (AREP)		1.5	

Single-bearing dimensions

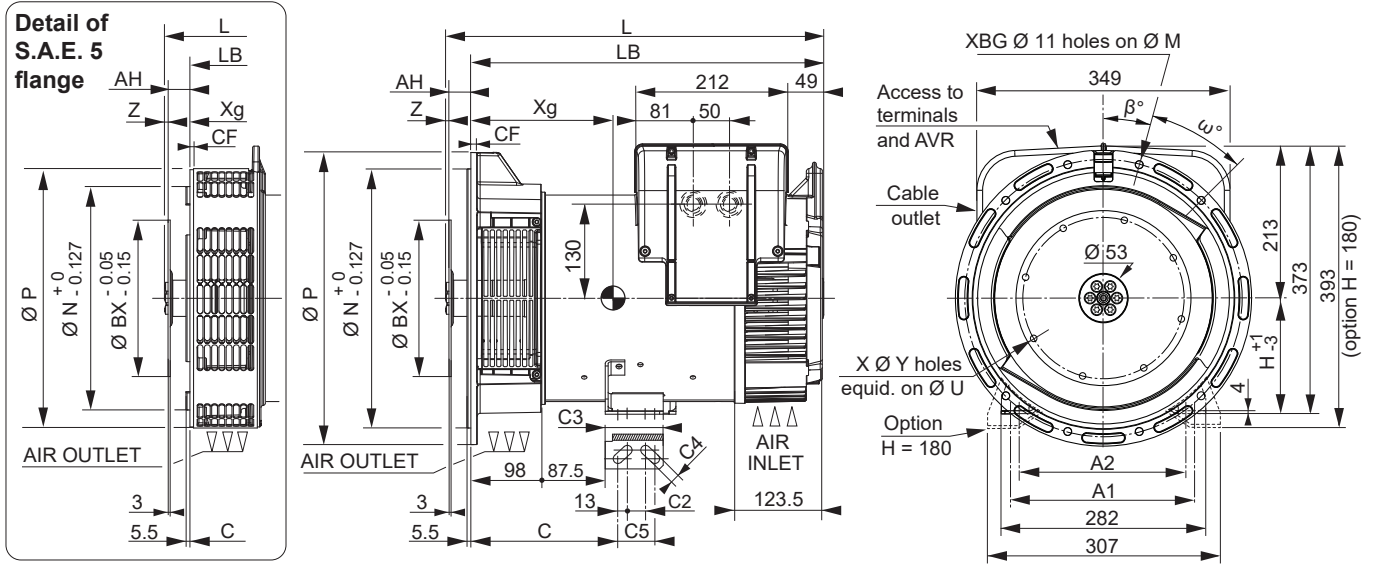

Dimensions (mm) and weight				
Type	L maxi*	LB	Xg	Weight (kg)
LSA 40 VS1	469	407	186	73
LSA 40 VS2	469	407	196	80
LSA 40 S3	499	437	204	87
LSA 40 S4	499	437	221	92
LSA 40 M5	519	457	221	102

* L maxi = LB + AH maxi + Z

Shaft height (mm)	Standard		Option
	H	160	180
C	203	238	
C2	25	22	
C3	80	60	
C4	13	12	
C5	51	22	
A1	254	279	
A2	230	-	

Coupling	Flange		
	3	4	5
Flex plate			
11 1/2	x	-	-
10	x	x	-
8	x	x	-
7 1/2	-	x	x
6 1/2	-	x	x

Flange (mm)							
S.A.E.	P	N	M	XBG	β°	ω°	CF
5	358	314.32	333.38	8	22°30'	45°	11
4	408	361.95	381	8*	15°	30°	9
3	460	409.58	428.62	8*	15°	30°	12

* Four lateral holes removal on S.A.E. 3 and 4

Flex plate (mm)						
S.A.E.	BX	U	X	Y	AH	Z
11 1/2	352.42	333.38	8	11	39.6	0
10	314.32	295.28	8	11	53.8	0
8	263.52	244.48	6	11	62	0
7 1/2	241.3	222.25	8	9	30.2	6
6 1/2	215.9	200.02	6	9	30.2	6

Torsional analysis data

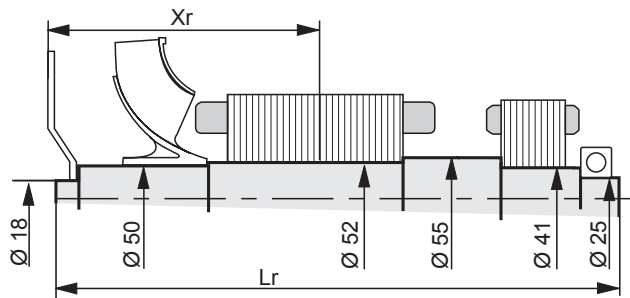

Centre of gravity: Xr (mm), Rotor length: Lr (mm), Weight: M (kg), Moment of inertia: J (kgm²): (4J = MD²)																				
Flex plate	S.A.E. 6 1/2				S.A.E. 7 1/2				S.A.E. 8				S.A.E. 10				S.A.E. 11 1/2			
	Type	Xr	Lr	M	J	Xr	Lr	M	J	Xr	Lr	M	J	Xr	Lr	M	J	Xr	Lr	M
LSA 40 VS1	211.7	428	25.54	0.0779	211.7	428	25.7	0.0802	243.5	428	26	0.0847	238.3	428	26.5	0.0964	221.1	428	27	0.1080
LSA 40 VS2	221.7	428	27.95	0.0867	221.7	428	28.11	0.0890	253.5	428	28.41	0.0935	248.3	428	28.91	0.1052	231.1	428	29.41	0.1168
LSA 40 S3	229.2	458	30.32	0.0936	229.2	458	30.48	0.0959	261	458	30.78	0.1004	255.8	458	31.28	0.1121	238.6	458	31.78	0.1237
LSA 40 S4	236.7	458	32.23	0.1004	236.7	458	32.39	0.1027	268.5	458	32.69	0.1072	263.3	458	33.19	0.1189	246.1	458	33.69	0.1305
LSA 40 M5	246.7	478	35.26	0.1102	246.7	478	35.42	0.1125	278.5	478	35.72	0.1170	273.3	478	36.22	0.1287	256.1	478	36.72	0.1403

NOTE : Dimensions are for information only and may be subject to modifications. Contractual 2D drawings can be downloaded from the Leroy-Somer site, 3D drawing files are available upon request. The torsional analysis of the transmission is imperative. All values are available upon request.

Two-bearing dimensions

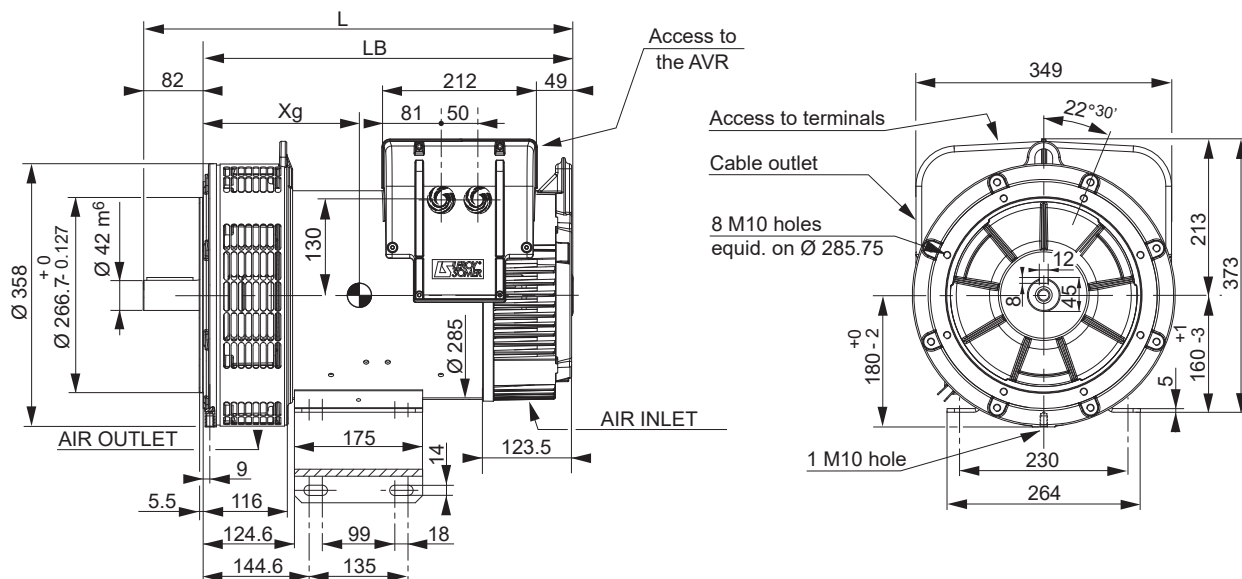

Dimensions (mm) and weight

Type	L	LB	Xg	Weight (kg)
LSA 40 VS1	507	425	198	82
LSA 40 VS2	507	425	208	89
LSA 40 S3	537	455	216	96
LSA 40 S4	537	455	233	101
LSA 40 M5	557	475	233	109

Torsional analysis data

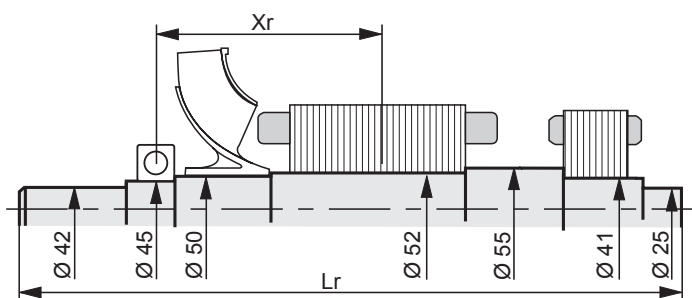

Centre of gravity: Xr (mm), Rotor length: Lr (mm), Weight: M (kg), Moment of inertia: J (kgm²): (4J = MD²)

Type	Xr	Lr	M	J
LSA 40 VS1	176.5	450.2	25.38	0.0731
LSA 40 VS2	186.5	450.2	27.79	0.0819
LSA 40 S3	194	480.2	30.16	0.0888
LSA 40 S4	201.5	480.2	32.07	0.0956
LSA 40 M5	211.5	500.2	35.10	0.1054

NOTE : Dimensions are for information only and may be subject to modifications. Contractual 2D drawings can be downloaded from the Leroy-Somer site, 3D drawing files are available upon request.

The torsional analysis of the transmission is imperative. All values are available upon request.

LEROY-SOMER[™]

www.leroy-somer.com/epg

Connect with us at:



Nidec
All for dreams

© 2024 Moteurs Leroy-Somer SAS. The information contained in this brochure is for guidance only and does not form part of any contract. The accuracy cannot be guaranteed as Moteurs Leroy-Somer SAS have an ongoing process of development and reserve the right to change the specification of their products without notice.

Moteurs Leroy-Somer SAS. Headquarters: Bd Marcellin Leroy, CS 10015, 16915 Angoulême Cedex 9, France. Share Capital: 32,239,235 €, RCS Angoulême 338 567 258.