

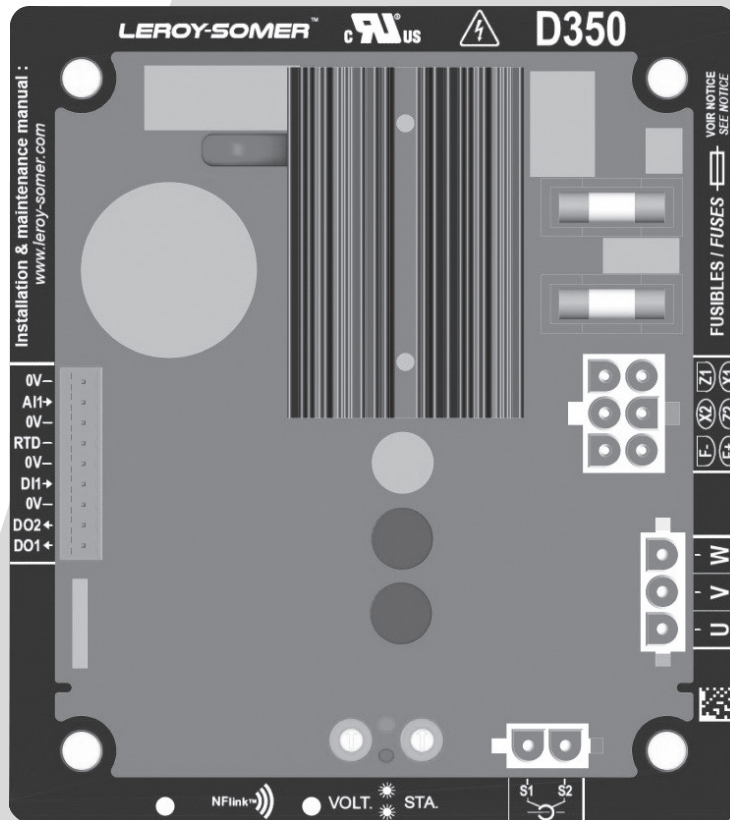

Power



D350

Digital Voltage Regulator

Installation and maintenance

D350

Digital Voltage Regulator

**This manual concerns the alternator AVR which you have just purchased.
We wish to draw your attention to the contents of this maintenance manual.**

SAFETY MEASURES

Before using your machine for the first time, it is important to read the whole of this installation and maintenance manual.

All necessary operations and interventions on this machine must be performed by a qualified technician.

For field applications relative to for instance nonlinear loads, transformers magnetizations or huge load impacts and load shedding, it is highly recommended to contact our technical support service in order to fine tune the factory settings of the voltage regulator.

Our technical support service will be pleased to provide any additional information you may require.

The various operations described in this manual are accompanied by recommendations or symbols to alert the user to potential risks of accidents. It is vital that you understand and take notice of the following warning symbols.

WARNING

Warning symbol for an operation capable of damaging or destroying the machine or surrounding equipment.



Warning symbol for general danger to personnel.



Warning symbol for electrical danger to personnel.



All servicing or repair operations performed on the AVR should be undertaken by personnel trained in the commissioning, servicing and maintenance of electrical and mechanical components.

WARNING

**This AVR can be incorporated in a EC-marked machine.
This manual is to be given to the end user.**

© 2024 Moteurs Leroy-Somer SAS

Share Capital: 32,239,235 €, RCS Angoulême 338 567 258.

We reserve the right to modify the characteristics of this product at any time in order to incorporate the latest technological developments. The information contained in this document may therefore be changed without notice.

This document may not be reproduced in any form without prior authorization.

All brands and models have been registered and patents applied for.

D350

Digital Voltage Regulator

Table of content

1. General Instructions	5
1.1. Identity sheet.....	5
1.2. General Presentation.....	5
1.2.1. The D350 AVR	5
1.2.2. NFLink™ configuration module	6
1.3. Technical characteristics.....	7
1.4. D350 AVR Dimensions.....	9
1.5. D350 AVR and NFLink™ Dimensions	10
1.6. Mounting.....	11
1.7. Wiring.....	11
1.7.1. Alternator voltage measurement:	11
1.7.2. Inputs/outputs	12
1.7.3. Power supply and excitation	14
1.7.4. Alternator current measurement (parallel operation CT):.....	16
1.8. Wiring precautions	16
2. Operations Instructions.....	18
2.1. Description of manual controls and signaling	18
2.1.1. The potentiometers.....	18
2.1.2. The LED	18
2.2. Description of the operating modes.....	19
3. Setting instructions	21
3.1. PC Software	21
3.1.1. Software installation	21
3.1.2. Different access levels of Easyreg Advanced	23
3.1.3. Description of the banner and tabs	24
3.1.4. Communication with the D350.....	26
3.1.5. “Configuration” window	27
3.1.6. Create a new quick configuration.....	30
3.1.6.1. Step 1: Selection of the alternator type.....	30
3.1.6.2. Step 2: Definition of the alternator features	31
3.1.6.3. Step 3: Wiring.....	31
3.1.6.4. Step 4: Regulation mode selection	32
3.1.6.5. Step 5: Configuration upload	33
3.1.7. Create a new configuration in custom mode	33
3.1.7.1. Step 1: Description of the alternator	34
3.1.7.2. Step 2: AVR wiring	35
3.1.7.3. Step 3: Definition of the over excitation limit	36
3.1.7.4. Step 4: Definition of stator current monitoring.....	37
3.1.7.5. Step 5: Definition of the protections.....	37
3.1.7.6. Step 6a: Setting of the voltage soft start	40
3.1.7.7. Step 6b: Voltage regulation.....	41
3.1.7.8. Step 6c: Regulation of the field current (Manual mode).....	47
3.1.7.9. Step 7: Setting the PID gains.....	49
3.1.7.10. Step 8: Inputs and outputs management.....	50
3.1.7.11. Step 9: Log Event.....	51

D350

Digital Voltage Regulator

3.1.7.12. Step 10: The Second Configuration	52
3.1.8. "Oscilloscope" window	53
3.1.8.1. Curves	53
3.1.8.2. Trigger	55
3.1.8.3. Cursors	56
3.1.8.4. Transient test	57
3.1.8.5. Open a curve or an oscilloscope display configuration	58
3.1.8.6. Save a curve or an oscilloscope display configuration	58
3.1.8.7. Change the plotting area background	58
3.1.9. "Monitor" window	59
3.1.9.1. Display units	59
3.1.9.2. Graph	60
3.1.9.3. Gauges	60
3.1.9.4. Change the size of an object	61
3.1.9.5. Delete an object	62
3.1.9.6. Save a monitor configuration	62
3.1.9.7. Open a monitor configuration	62
3.2. Operations as analogue AVR	63
3.2.1. Voltage setting	63
3.2.2. Stability setting	64
3.2.3. Droop compensation	64
3.2.4. Switching 50/60Hz	64
3.3. Tips and tricks	65
3.4. Comparison window	65
4. APPENDICES	67
4.1. Vector permutations	67
4.2. Regulation modes prioritization	68
4.3. Electrical diagrams	69
4.3.1. SHUNT	69
4.3.2. AREP	70
4.3.3. PMG	71
4.4. Faults trouble shooting	72
4.4.1. No Voltage	72
4.4.2. Voltage too low	73
4.4.3. Voltage unstable	74
4.4.4. Important voltage drop on load	75
4.4.5. Time response too long	76

D350

Digital Voltage Regulator

1. General Instructions

1.1. Identity sheet

The D350 AVR is designed by:

Moteurs Leroy-Somer SAS
Boulevard Marcellin Leroy, CS 10015
16915 ANGOULEME Cedex 9, France

Description	Type	Code
Digital AVR	D350	5124059
Configuration module	NFLink	5124189

1.2. General Presentation

1.2.1. The D350 AVR

This manual describes how to install, use, set up and maintain the D350 AVR.

The purpose of this AVR is to regulate alternators with a field current of less than 5 A in continuous operations, and 10 A maximum in the event of short-circuit for 10 seconds maximum.

Its design is in accordance with mounting in a generator terminal box or a control cabinet. It is required, at a minimum, to follow the local protection and safety standards, especially those specific to electrical installations for voltages of 300 Vac phase-to-neutral maximum.

Similarly to the other AVR, the D350 is an electronic printed circuit board, protected with a polyurethane resin as show on the figure below.

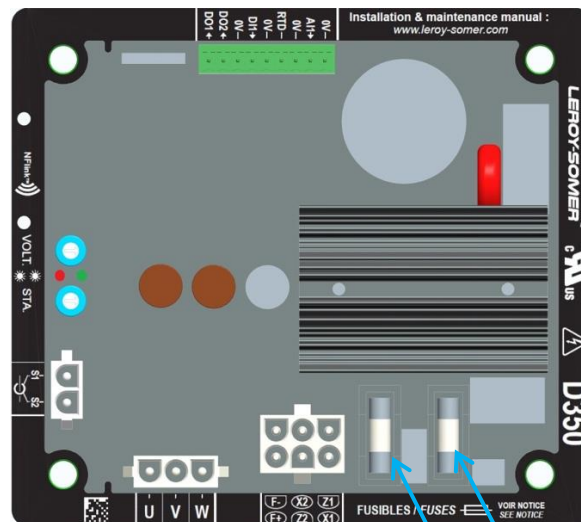

Fuse references

- In standard:

F1: 10A 250V ref. Mersen Q206071T or equivalent

F2: 10A 250V ref. Mersen Q206071T or equivalent

- For UL applications:

F1: 8A 250V ref. Mersen T084013T or equivalent

F2: 10A 250V ref. Mersen Q206071T or equivalent

F1

F2

D350

Digital Voltage Regulator

1.2.2. NFLink™ configuration module

The D350 AVR is equipped with NFC¹ technology for communication and configuration purposes. The configuration module hereafter called NFLink™ is placed on the plastic enclosure thanks to two dedicated positioning holes as shown below.

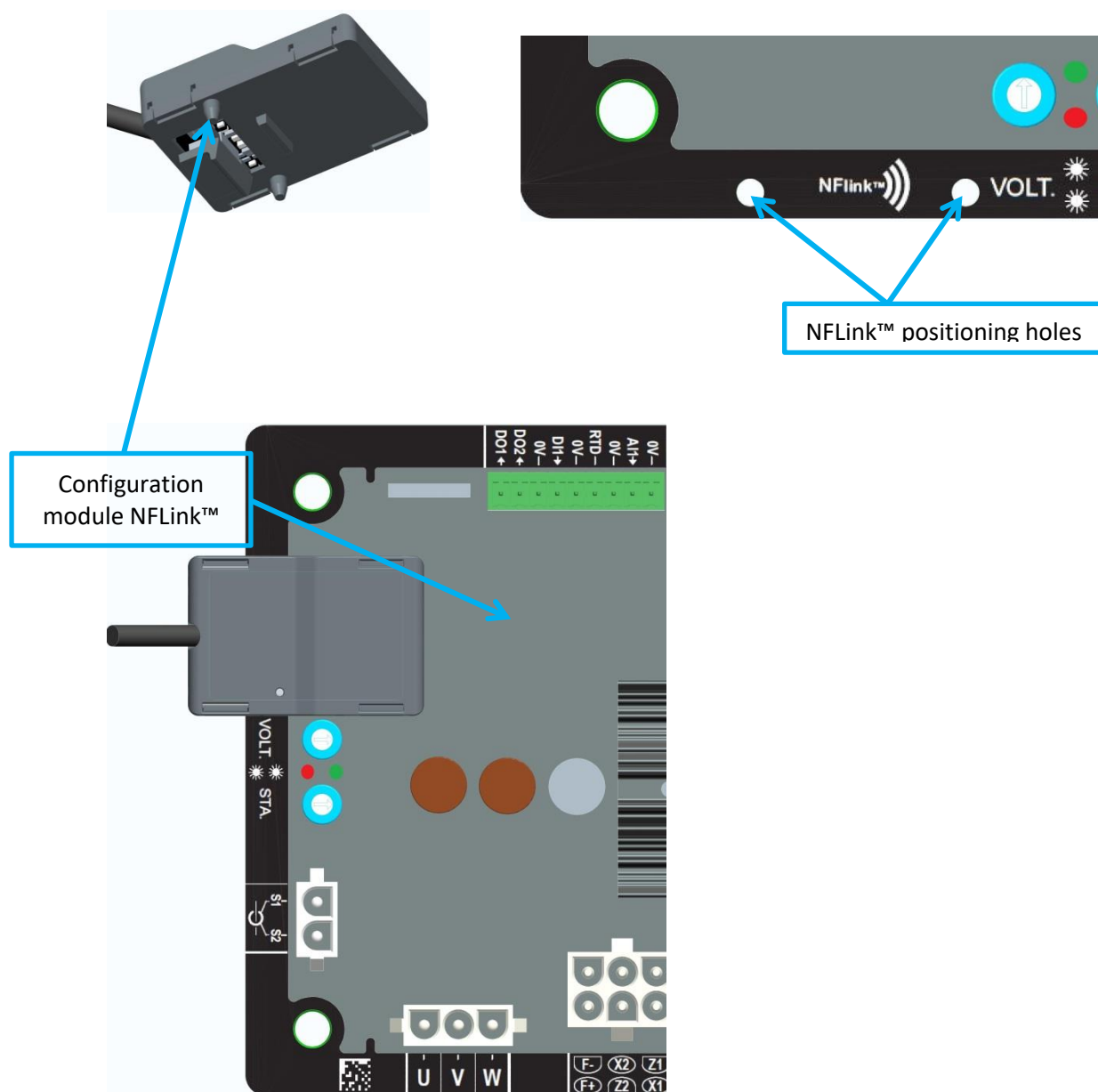

NOTE: A holding system placed at the bottom of the NFLink ensures a mechanical strength hold on the D350 plastic board. Once the configuration is done, the NFLink must be removed as it is not supposed to be left on the D350 when it is in continuous operation.

¹ Near Field Communication

D350

Digital Voltage Regulator

1.3. Technical characteristics

The D350 AVR is a digital voltage regulator used to control the alternator from the field current or the output voltage regulation loops.

- Voltage regulation:
 - With or without reactive droop compensation droop to allow parallel machine operation.
 - With or without line droop compensation.²
- Regulation of the field current, or manual mode, which allows direct control of the field current value.

The D350 can also be used to:

- Adjust the reference for the regulation mode in progress, using an analogue input (0-10V and potentiometer)
- Monitoring of temperature sensor (Pt100 or CTP)
- Limit the minimum field current delivered to the exciter field
- Monitoring of the maximum stator current limit
- Loss of voltage sensing
- Withstand a sudden short-circuit for 10 seconds maximum in AREP, PMG
- Signals monitoring (events logger)

The various trip, regulation mode and measurement data items can be delivered onto the 2 digital outputs.

- **Alternator voltage sensing**
 - 3 phases without neutral, 2 phases or 1 phase with neutral
 - Three-phase range 0-530Vac
 - Consumption < 2VA
- **Stator current measurement with CT**
 - Range 0-1A ou 0-5A
 - Consumption < 2VA
- **Power supply**
 - **AC**
 - 4 terminals for PMG, AREP, SHUNT
 - Range 50-277 Vac
 - Consumption max < 3000VA
 - **DC (preloading not managed)**
 - Range 50-400 Vdc
 - Consumption max < 3000VA
- **Field excitation**
 - Rated 0-5 A
 - Short-circuit 10A max.
 - Field winding resistance > 4 ohms
- **Frequency**
 - Range 10-100Hz

²The reactive droop and the line droop compensation cannot be simultaneously enabled and a current transformer is required in both cases.

D350

Digital Voltage Regulator

- Regulation accuracy:
 - +/-0.25% of the average of the three phases with harmonic distortion less than 5%
 - +/-0.5% of the average of the three phases with harmonic distortion up to 20% (harmonics associated to six-thyristors load type)
- Voltage adjustment range: 0 to 150% of the rated voltage
- Quadrature droop adjustment range: -20% to 20%
- Under frequency protection: integrated, adjustable threshold, slope adjustable from 0.5 to 3 x V/Hz in steps of 0.1 V/Hz
- Excitation ceiling: adjustable by configuration at 3 points
- Environment: ambient temperature from -40°C to +65°C, relative humidity of less than 95%, non-condensing, mounted in a cabinet or in a terminal box
- AVR parameters set using software "EasyReg Advanced" provided by Nidec Power
- Dimensions:
 - Height: 52.9mm
 - Width: 125mm
 - Length: 140mm
- Mounting:
 - Holes spacing on the Length: 115mm
 - Holes spacing on the width: 100mm
- Weight: 0.45kg
- Conformity to standards:
 - EMC: IEC 61000-6-2, IEC 61000-6-4
 - Humidity: IEC 60068-1 and test in accordance with IEC 60068-2-14
 - Dry heat: IEC 60068-2-2
 - Damp heat: IEC 60028-2-30
 - Cold: IEC 600068-2-1

D350

Digital Voltage Regulator

1.4. D350 AVR Dimensions

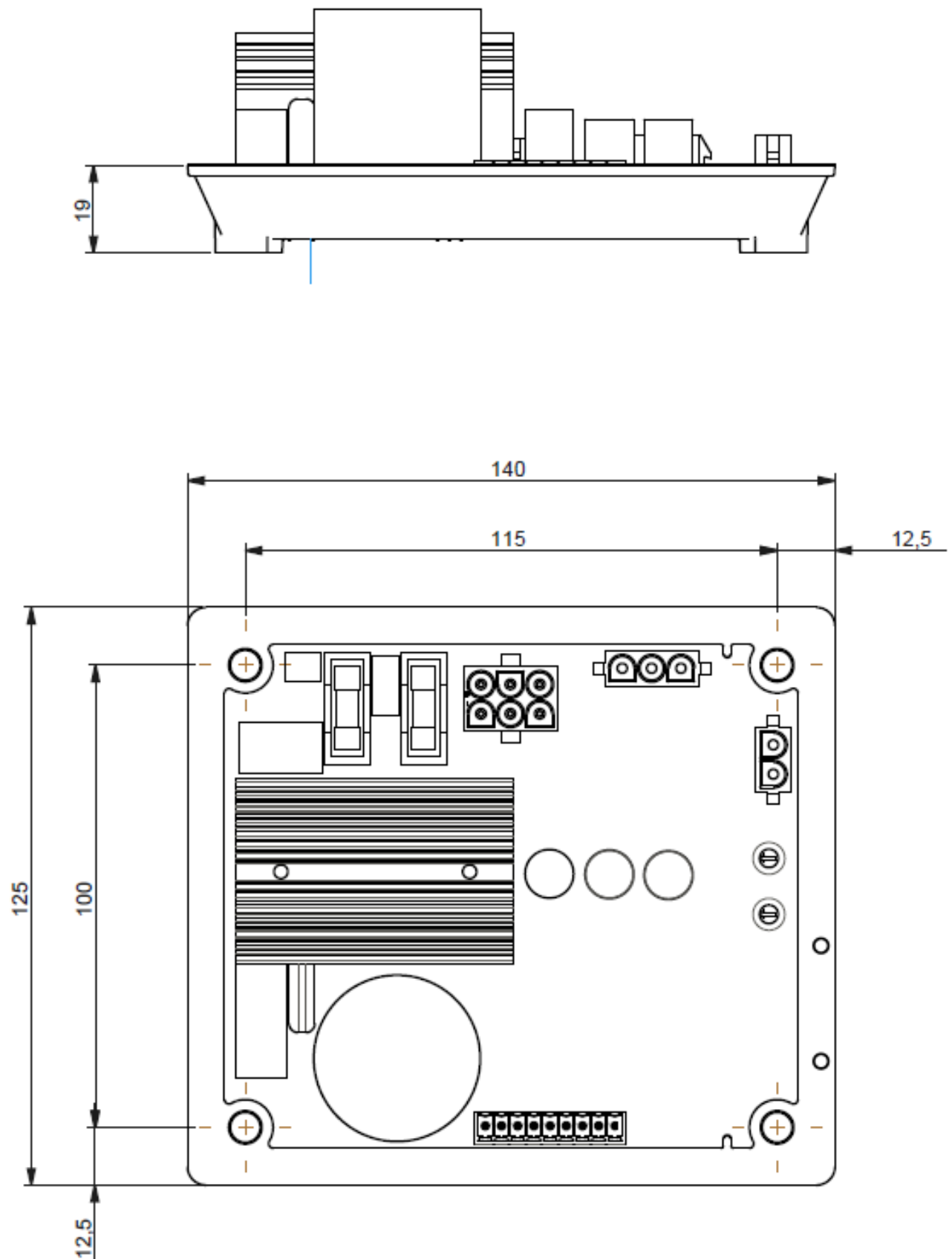

D350

Digital Voltage Regulator

1.5. D350 AVR and NFLink™ Dimensions

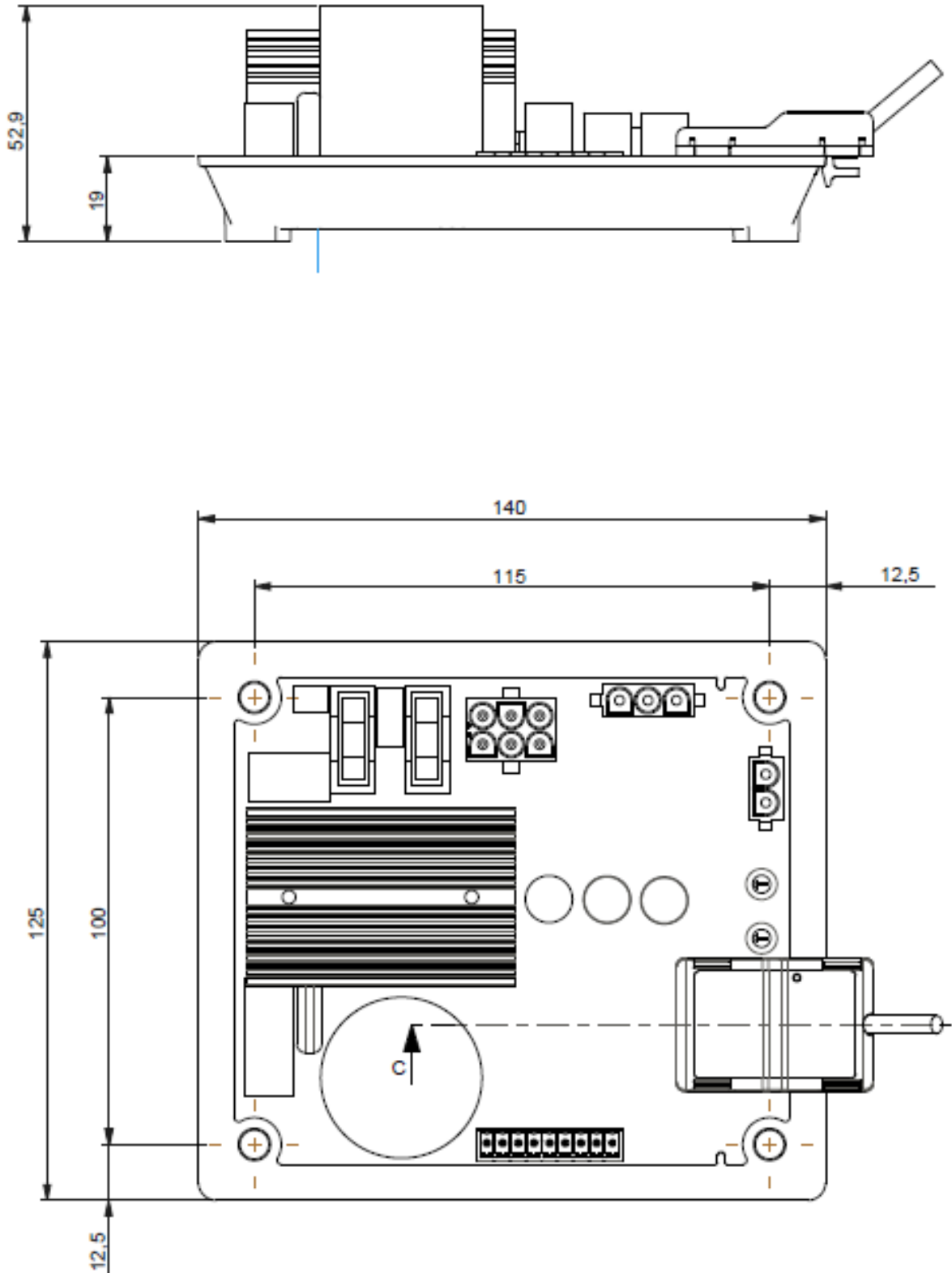

D350

Digital Voltage Regulator

1.6. Mounting

The D350 is mounted on a mechanical part on the terminal box or the cabinet with 4xM5 screws and the nominal screwing torque is de 2.5 N.m.

1.7. Wiring



The AVR and its connections are not isolated against alternator stator outputs. There is a risk of electrical shock. All wiring and connection operations must be performed only by qualified personnel and upon a stopped, de-excited machine.

The D350 must be connected to the different measurement, power and control signals to ensure the proper regulation functions.

1.7.1. Alternator voltage measurement:



Figure 1 : Alternator voltage sensing

Voltage transformers are mandatory if the alternator voltage measurement is higher than 480 Vac rms phase-to-phase (530Vac rms maximum for 10 seconds or 277 Vac rms between phase and neutral).

Connection	Electrical Schematic
Phase / Phase (with or without PT)	
3 Phases with or without PT)	

NOTE: The alternator voltage measurement connection must match the alternator current measurement transformer mounting phase. Failure to respect this recommendation, bad reactive power sharing will occur when operating in parallel between alternators.

D350

Digital Voltage Regulator

NOTE 2: If necessary, see the appendix for examples of vector permutations.

1.7.2. Inputs/outputs

The D350 is equipped with one digital input, one analog input, one temperature input (PT100 or CTP) and two digital outputs. The figure below gives an overview of these inputs/outputs.

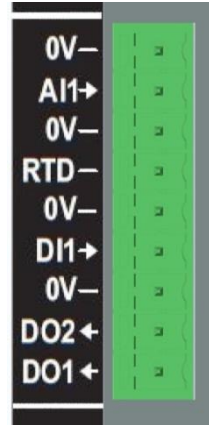

- **PT100 input**

Only 2 wires Pt100 can be used:

Connection	Electrical schematic
Without compensation	<p>The schematic shows a PT100 sensor with two wires. One wire is connected to the 0V terminal of the RTD input block. The other wire is connected to the RTD terminal of the same input block. The 0V terminal of the input block is also connected to the 0V terminal of the terminal block.</p>

The measurement range for these temperature sensor inputs is between -50°C and 250°C and two thresholds can be defined: the alarm threshold and the trip threshold.

CAUTION: The PT100 input is non-isolated.

- **PTC input**

This input allows to use a PTC which suddenly increases when the temperature reaches a threshold. Different resistance thresholds are defined for 2 PTC configurations but the user can customize these values according to this sensors. This customization is done via the PC software Easyreg Advanced.

Connection	Electrical schematic
1xCTP or 3xCTP	<p>The schematic shows a PTC/CTP sensor with two wires. One wire is connected to the 0V terminal of the RTD input block. The other wire is connected to the RTD terminal of the same input block. The 0V terminal of the input block is also connected to the 0V terminal of the terminal block.</p>

D350

Digital Voltage Regulator

- **Analog input:**

The analog input can be configured in two modes:

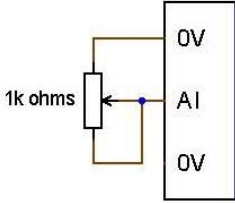
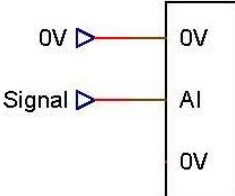
Connection	Electrical schematic
Potentiometer	
0/+10V	

This input is defined by its type (potentiometer or 0/10V) and by its minimum and maximum limits.

CAUTION: The analog input is non-isolated.

- **Digital output:**

Each digital output is open collector transistor type. They can each withstand a maximum voltage of 24 Vdc and 60 mA maximum.

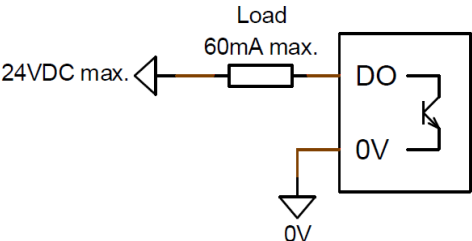
Connection	Electrical schematic
Digital output	

They are configured by a source parameter (alarm, regulation mode in progress, etc.) and their activation mode: normally open (active low) or normally closed (active high).

CAUTION: The digital outputs are non-isolated. Watch out for the risk of reversed polarity on the voltage which could cause the output to break.

D350

Digital Voltage Regulator

- **Digital input:**

It should be controlled by a volt-free contact.

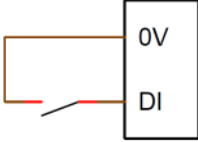
Connection	Electrical schematic
Digital input	

It is configured by a destination parameter (control of a regulation mode, motor starting, switch to second configuration, etc.) and its activation mode: normally open (active low) or normally closed (active high).

CAUTION: The digital input is non-isolated.

1.7.3. Power supply and excitation

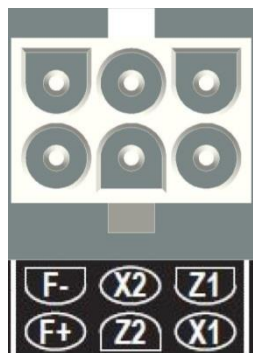

- **Excitation:**

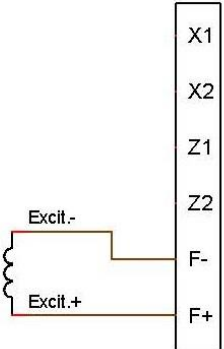
Connection	Electrical schematic
Excitation	

- **Power supply:**

The D350 power stage can take several different source types: shunt, PMG, AREP. This stage consists of rectifier diodes as in the electrical schematic below.

D350

Digital Voltage Regulator

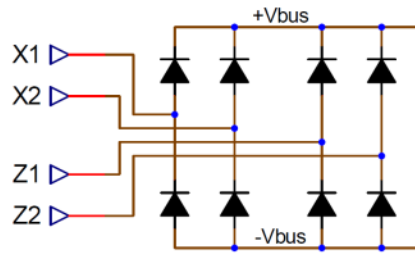

NOTE: According power supply, a suitable capacitor preloading system will be implemented so as to avoid damaging them. Total capacitor value: 330 μ F. Maximum preloading current 2A.

The maximum power supply voltage is 300Vac between each of the connection points X1, X2, Z1, Z2.

Connection	Electrical schematic
AREP	
PMG	
2-phase SHUNT with power voltage transformer	

D350

Digital Voltage Regulator

Connection	Electrical schematic
Phase-to-neutral SHUNT (low voltage)	

1.7.4. Alternator current measurement (parallel operation CT):

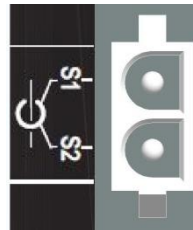

The alternator current can be measured on phase U as shown on the figure below.

Connection	Electrical schematic
CT on phase U	

1.8. Wiring precautions

Cables must never exceed 100 m in length.

To ensure respect of standards IEC 61000-6-2, IEC 61000-6-4, shielded cables are imperative in case of a D350 installed outside of the terminal box.

The total ohmic value of the exciter loop (out and back) must not exceed 5% of the exciter resistance, regardless of the cable length.

D350

Digital Voltage Regulator

The total ohmic value of the power system cables must not exceed 5% of the exciter resistance, regardless of the cable length.

For information, the resistance at 20°C in mΩ/m for copper cables is approximately:

Cross-section (mm ²)	Resistance (mΩ/m)
1,5	13,3
2,5	7,98
4	4,95
6	3,3
10	1,91

Calculation example:

For a 10 ohm exciter

- Maximum cable resistance = 0.5 ohms (2 x 0.25 ohms)
- Cross-section as a function of the distance between the AVR and the alternator:

Distance (m)	Cross-section (mm ²)
30	2,5
50	4
75	6
100	10

D350

Digital Voltage Regulator

2. Operations Instructions

The D350 AVR has operations range limits that must be respected. Incorrect settings of voltages and currents could lead to partial or total damage of the regulator and/or the alternator.

2.1. Description of manual controls and signaling

The D350 is equipped with potentiometers and LEDs to ensure interaction between the regulator and the environment.

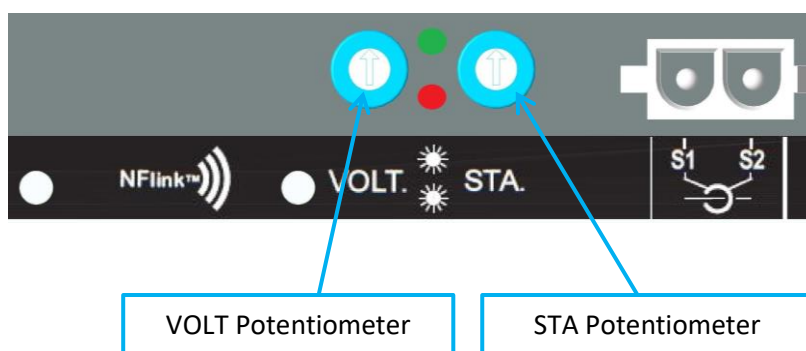

2.1.1. The potentiometers

VOLT Potentiometer is dedicated to the voltage setting. It allows to adjust the alternator output voltage in a predefined range, for example 380V-420V. The VOLT Potentiometer can be activated via the configuration software and when deactivated, any operation on the potentiometer will be ignored.

STA Potentiometer can be assigned either to the PID global gain (sometimes called Stability) or the reactive droop compensation. The PC software allows to select the assignment and the variation range.

2.1.2. The LED

The different statuses of the two LEDs are given in the table below in relation with the events or operations they are assigned to.

Description	GREEN LED	RED LED
Normal operation	ON	OFF
Voltage loss of sensing (1s) Stator short-circuit(10s)	OFF	Flashing
Loss of sensing fault Stator short-circuit fault	OFF	ON
Overload and overheating	ON	Flashing
NFC Communication + generator stopped	Flashing	OFF
Firmware upgrading	Flashing	Flashing

D350

Digital Voltage Regulator

2.2. Description of the operating modes

The various regulation modes to be configured depend on the alternator operation (standalone, parallel between machines). Based on these different operating modes, certain function will need to be enabled.³ The simplest examples are shown below.

- **Example no. 1: The alternator only is connected to a load (factory, lighting, pump, etc.)**

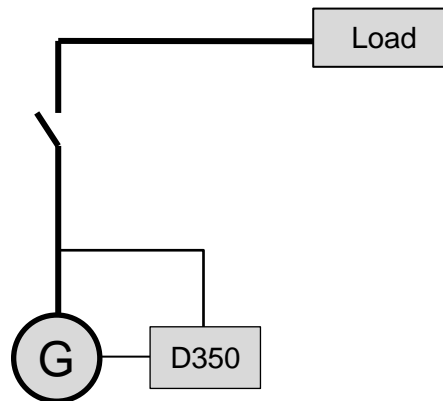

- **The AVR is operating in voltage regulation mode only.**
- There is no need to measure the alternator current. In this example, no power rating can be indicated, and the line droop compensation cannot be enabled, nor does the quadrature droop.
- No quadrature droop correction is needed.
- Load compensation can be enabled in the case of long-distance connections so as to ensure there is a minimum voltage at the load terminals.⁴
- **Field current regulation is optional.** In this case, the reference must be permanently set so that it matches the existing load and will not risk any damage to the load or the machine (risk of overvoltage or under voltage and risk of over excitation).

³ The following schematics are given for information only; they do not take into account any voltage sensing transformers.

⁴ In this case, one alternator current measurement transformer is needed.

D350

Digital Voltage Regulator

- **Example no. 2: The alternator is connected to other alternators and a load (factory, lighting, pump, etc.)**

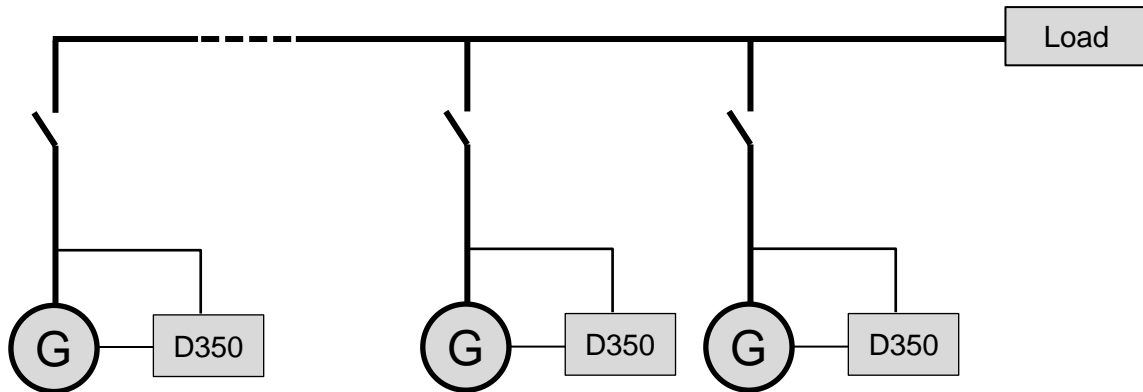

- **The AVR is operating in voltage regulation mode only.**
- In order to divide the load reactive power equally between all the machines which are running, the Quadrature droop must be enabled: voltage drop according to the percentage of rated reactive load applied to the machine. In this case, alternator current measurement is mandatory on the alternator current measurement input.
- NOTE: Load compensation cannot be enabled if quadrature droop is active.
- **Field current regulation is optional.** In this case, the reference must be permanently set so that it matches the existing load and will not risk damaging the load or the machine (risk of overvoltage or under voltage and over excitation).

D350

Digital Voltage Regulator

3. Setting instructions

3.1. PC Software

All the D350 settings can be entered using the "EasyReg Advanced" software available as a free download:

<https://acim.nidec.com/generators/leroy-somer/downloads/software/easyreg-advanced>.

The parameter-setting pages describe primarily the alternator parameters, regulations, limits, and protection devices.

3.1.1. Software installation

EasyReg Advanced® is the software to be used for configuring the regulator.

NOTE: This program is only compatible with computers running WINDOWS® versions Windows 7 and Windows 10 operating systems.

Execute this program, checking first that you have "Administrator" rights for your terminal.

Step 1: Choose the installation language

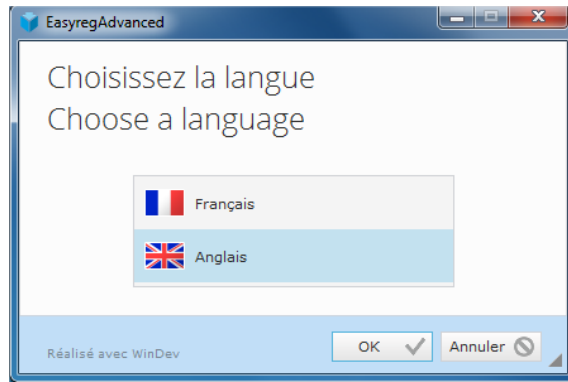

Step 2: Choose the installation type:

- Quick installation: the files are copied automatically and the software directory is created
- Custom installation:
 - Choose the installation directory

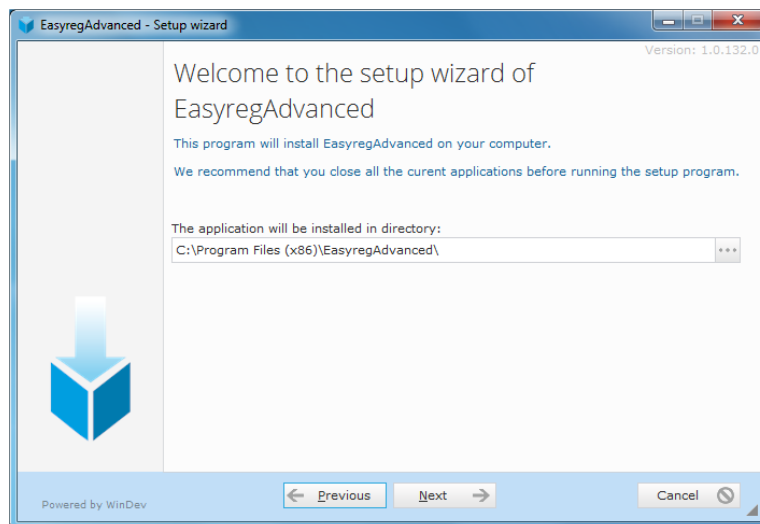

- After selecting the directory, click "Next"

D350

Digital Voltage Regulator

- Confirm by clicking “Install” if the path is as expected

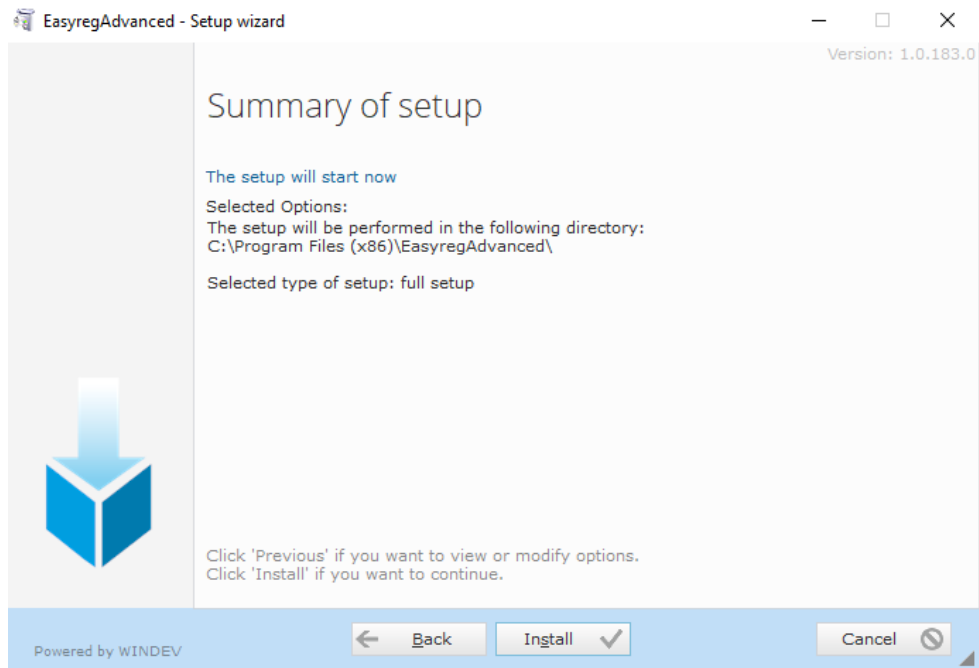

Step 3: Once installation is complete, you can choose to start the software (box ticked by default) and to manage the shortcuts. Click on “Done” to quit the installation page.

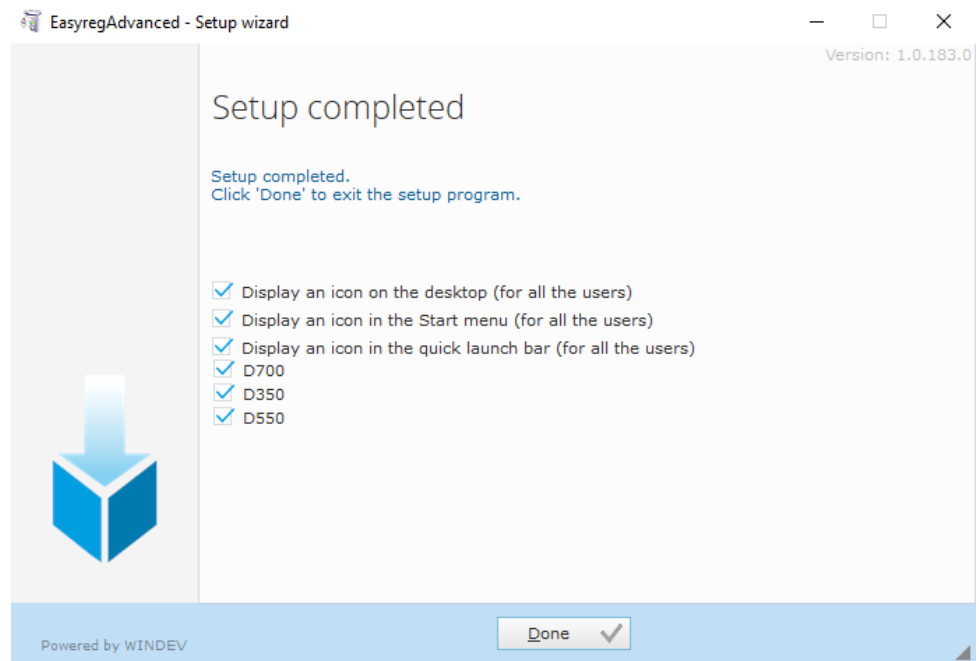

A shortcut is created on your desktop:

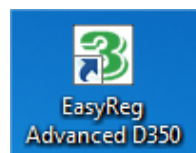

D350

Digital Voltage Regulator

3.1.2. Different access levels of Easyreg Advanced

Two modes are available:

- Standard: for read only access to the parameters.

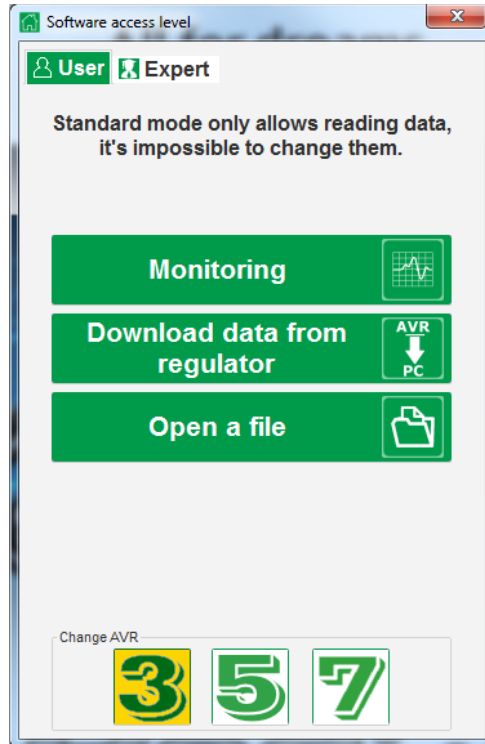

- Expert: for full access to the different functions of the regulator in read and write mode.

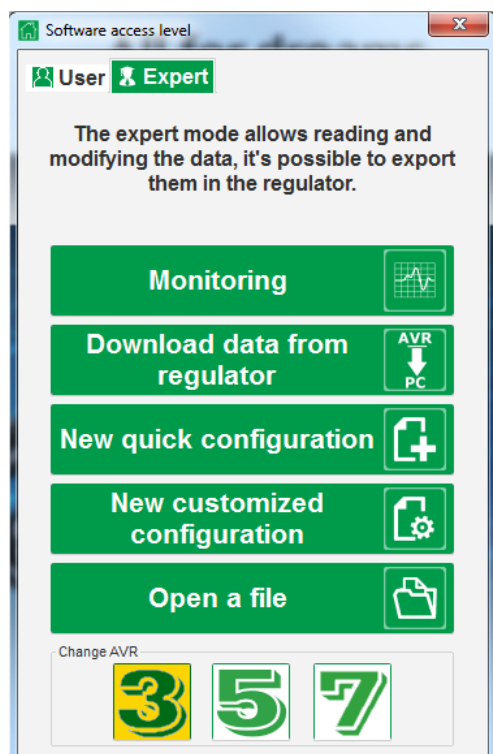

D350

Digital Voltage Regulator

3.1.3. Description of the banner and tabs

The software takes the form of a single window with a general banner and a bottom zone where sub-windows are opened.

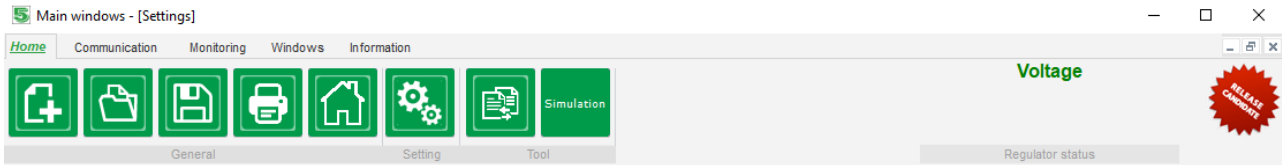

The banner consists of 5 tabs:

- "Home" tab:

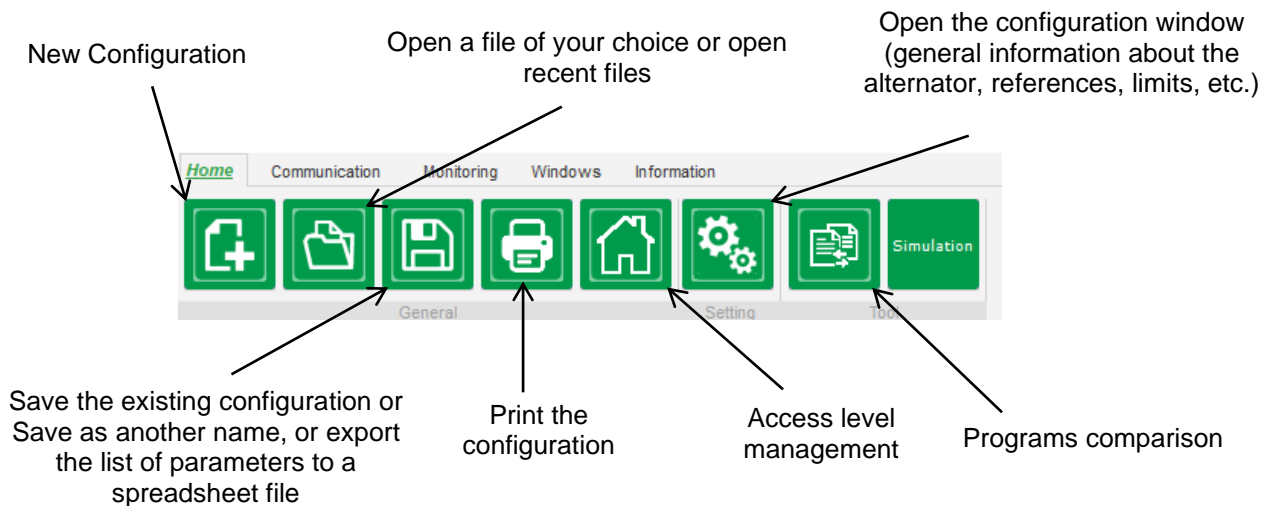

- "Communication" tab:

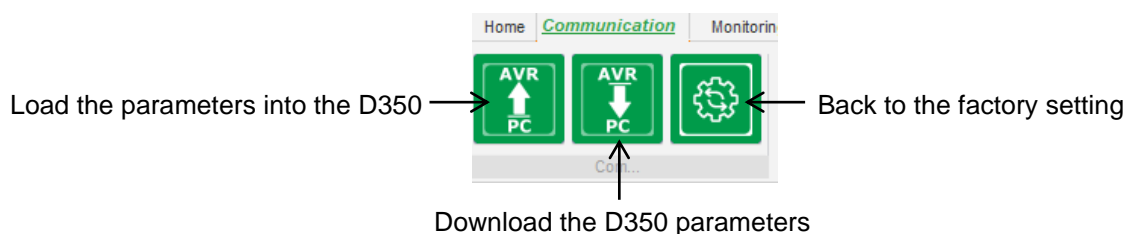

NOTE: Before parameters are exported the user will be asked to confirm and to check the product status (regulation in progress or not). If regulation is in progress, confirmation is requested again.

D350

Digital Voltage Regulator

- “Monitoring” group:

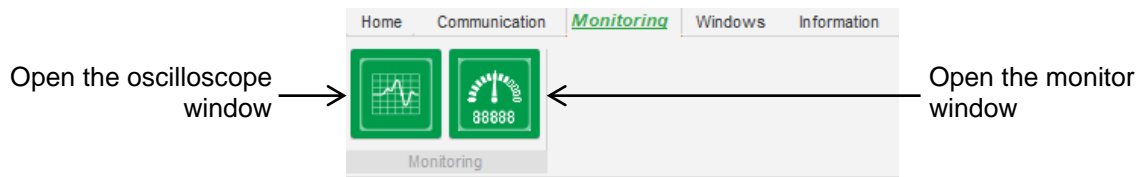

- “Windows” group:

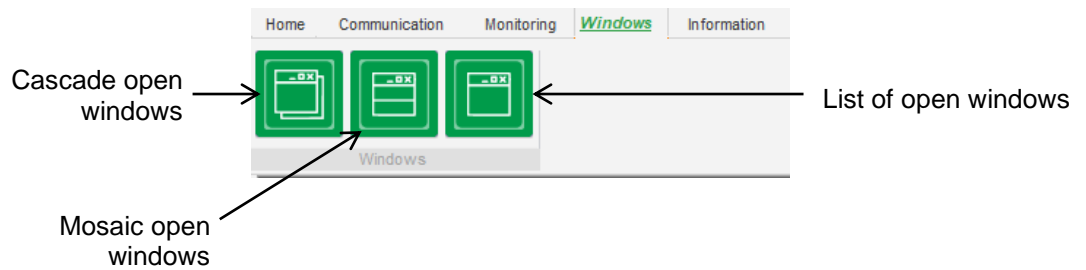

- “Information” group:

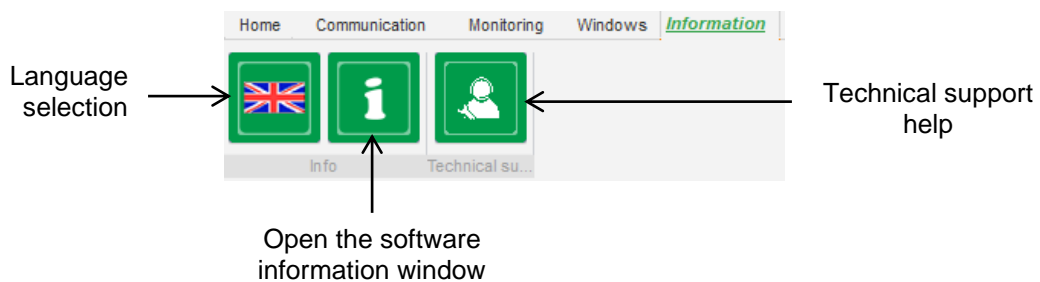

D350

Digital Voltage Regulator

The D350 is equipped with running hours counter accessible in the « About  » window (given in hours and minutes). The firmware update can also be done in this window as shown below.

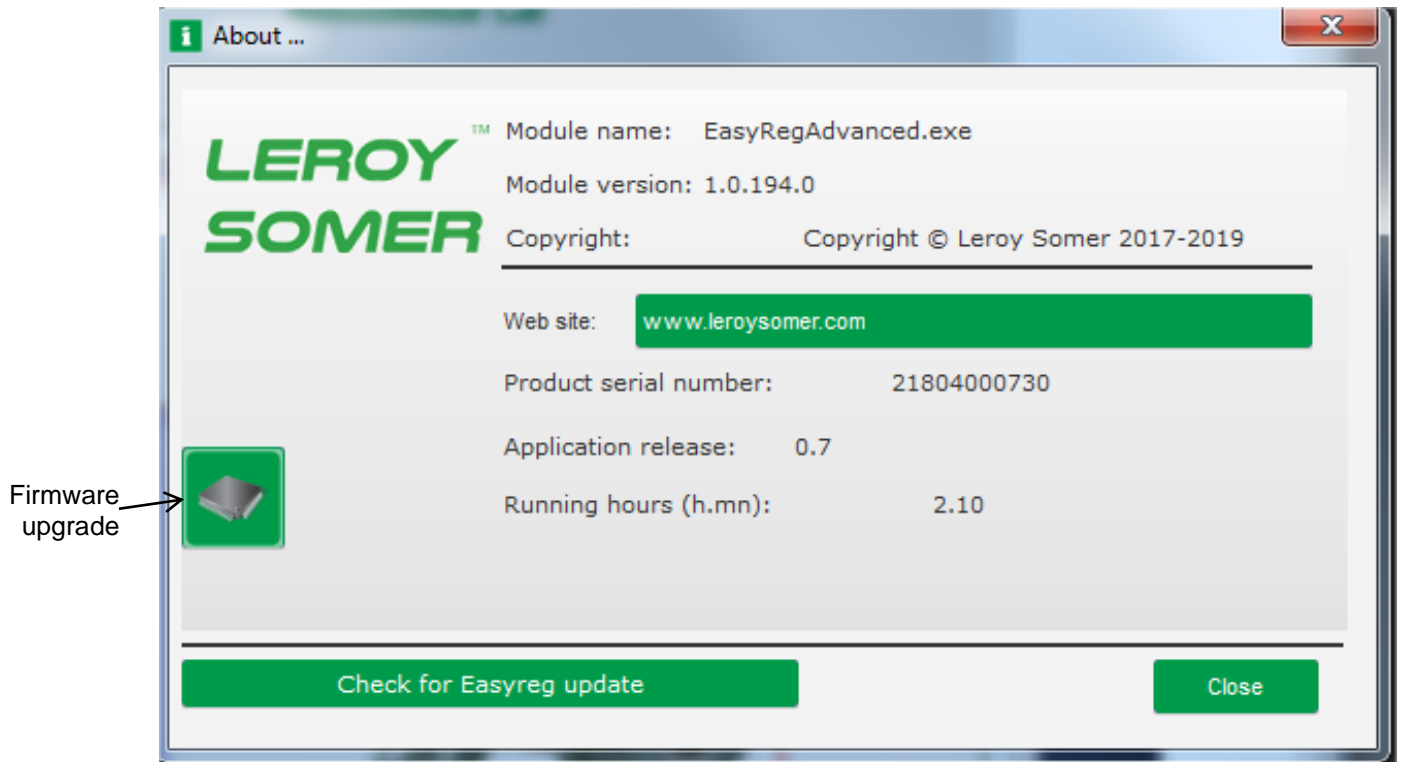

NOTE: This counter is updated every 10min and only when the voltage regulation setpoint is reached.

- "Regulator state" window:

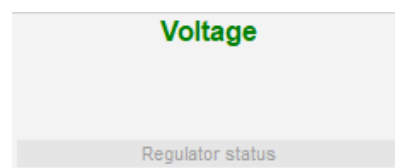

3.1.4. Communication with the D350

Communication between the D350 and the PC software is done thanks to the NFLink module. When the communication is established, a confirmation message is displayed on the bottom left of the PC software as shown below.

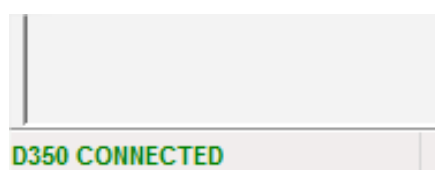

D350

Digital Voltage Regulator

3.1.5. “Configuration” window

This window consists of several pages for configuring the entire alternator operation. To move between pages, use the “Next” or “Previous” buttons or click on the list of pages.

NOTE: More details of these pages are given in the sections describing how to create a new quick or customized configuration.

- **Description of the alternator:** this page contains all the alternator electrical characteristics, plus the field excitation data.

The screenshot shows the 'Settings' window for the D350 Digital Voltage Regulator. The title bar reads 'Settings' and the window title is 'Generator description'. There are 'Next' and 'Previous' navigation buttons. The interface is split into two columns. The left column contains input fields for 'Application name' and 'D350 serial number'. Below these are two sections: 'Generator data' and 'Excitation data'. The 'Generator data' section has the following values: Rated voltage (V) 400,00; Rated frequency (Hz) 50,00; Rated power factor 0,80; Rated apparent power (kVA) 350,00; Rated nominal power (kW) 280,00; Rated reactive power (kVar) 210,00; Rated current (A) 505,18. The 'Excitation data' section has: Field inductor resistance (Ohms) 12,30; Shutdown field current (A) 0,00; Rated field current (A) 5,00. The right column shows a 'Grid/Load' diagram with a green alternator and a control panel. The diagram shows a 500V (0V) connection point and labels for V, W, and U phases.

- **Wiring:** this page contains all the D350 wiring data for the measurement inputs (alternator voltage and current). Each time the wiring is modified by selection of a VT or CT, the drawing changes.

D350

Digital Voltage Regulator

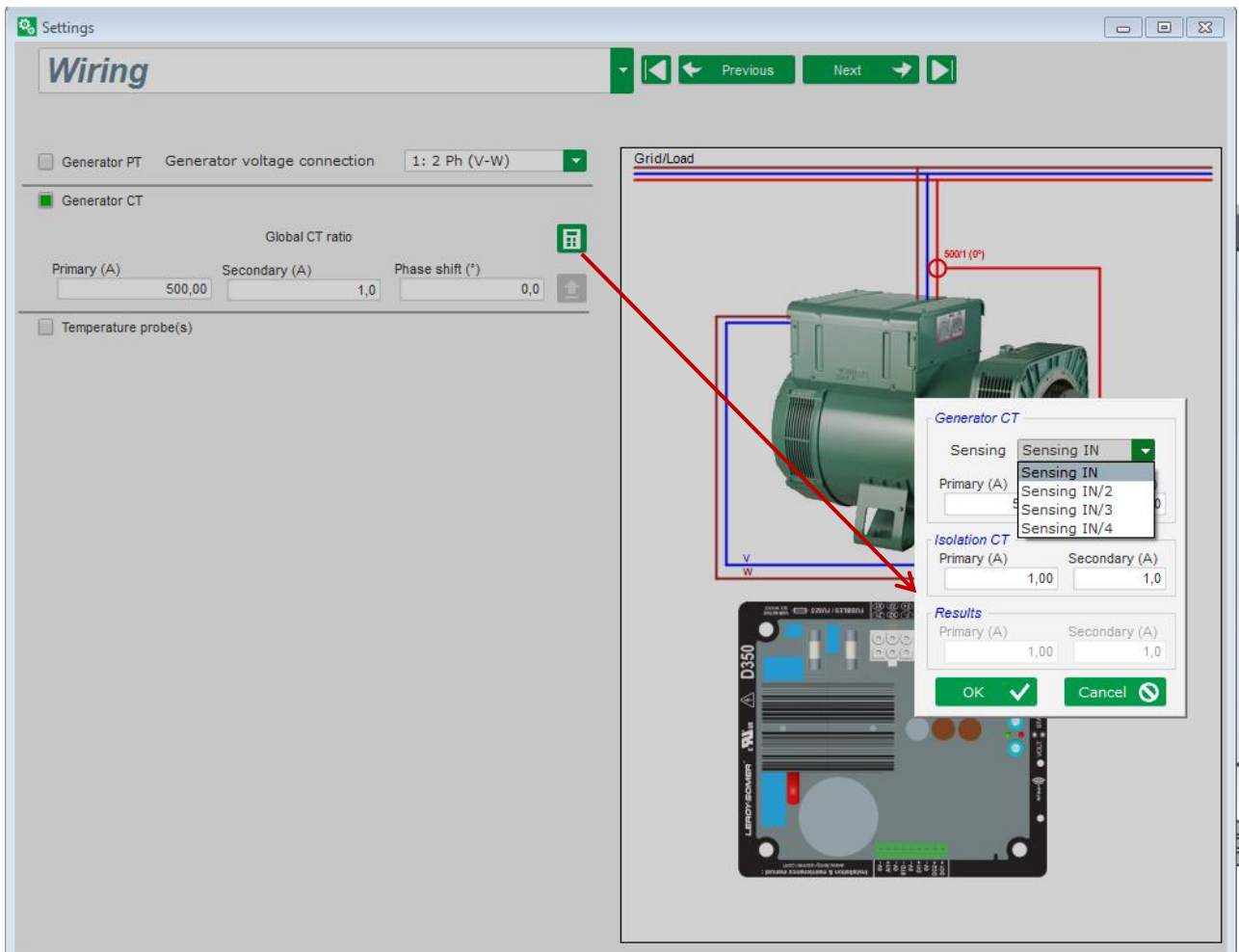

When the CT only measures part of the generator total current, the help button to access to the advanced level of CT settings as shown above.

- **Faults and Protections:** This page contains the parameter settings for the protection devices provided by the D350 (over and under voltage, temperatures, etc.).

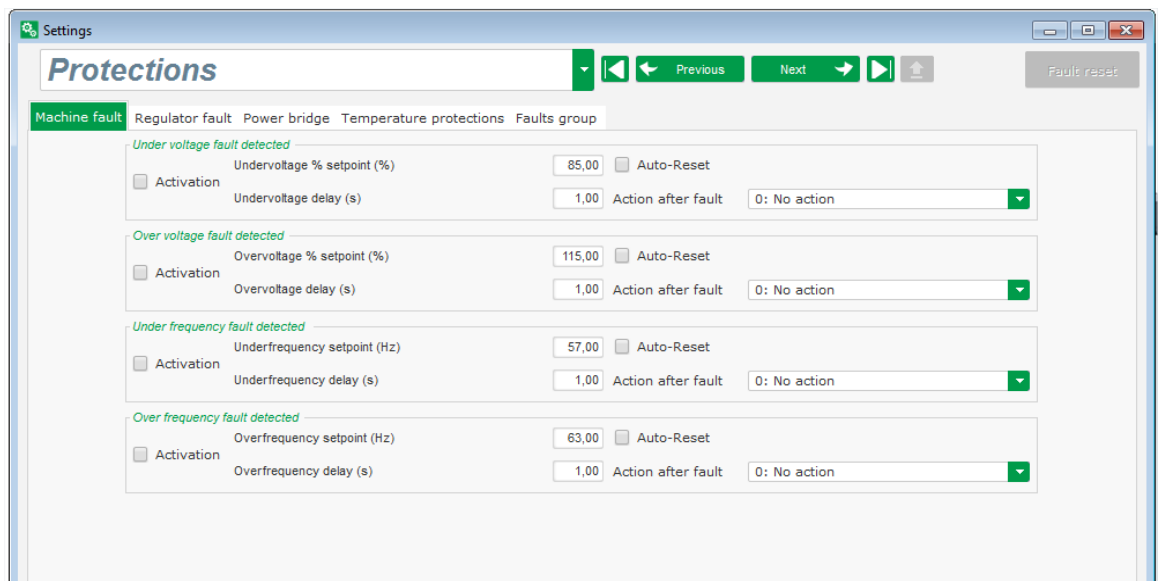

D350

Digital Voltage Regulator

- **Regulation modes:** this page contains all the regulation parameter settings: active regulations, references and their adjustments.

Regulation mode

Start-up: Voltage | Field Current

Regulation enabled by: Always enabled

Unom (V): 400,00

Max. setpoint(% Unom.): 132,50

Min. setpoint(% Unom.): 0,00

Setpoint adjustment: Active

Analog Input configuration: Analog input POT

Lower deviation (V): -100,00 | Upper deviation (V): 0,00

Underspeed: Knee (Hz): 48,0 | Slope (V/Hz): 1,0

Reactive droop compensation (%): 3,0

Engine help: Soft voltage recovery (s/%): 0,100 | Smart L.A.M. (%): L.A.M. (%):

TYPICAL UNDERSPEED CURVE

REACTIVE DROOP CURVE

- **PID settings:** this page contains all the values for the PID settings.

PID settings

	Voltage	Field current
Proportional	9 000	2 000
Integral	100	50
Derivative	900	15
Gain	100	100

DC Bus voltage compensation: ?

AVR PC Upload your configuration

Grid/Load diagram showing motor and regulator connection.

D350

Digital Voltage Regulator

3.1.6. Create a new quick configuration

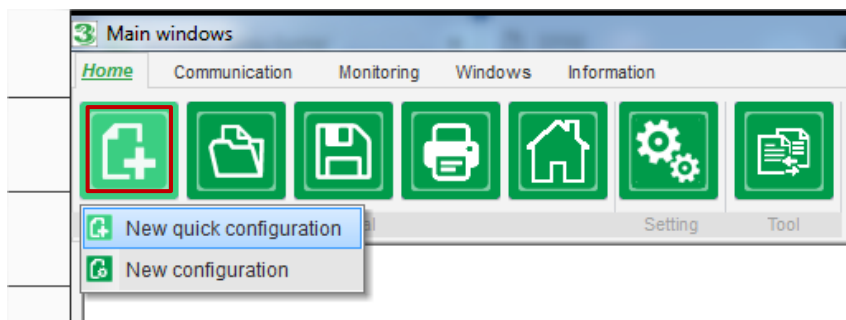

3.1.6.1. Step 1: Selection of the alternator type

Select the alternator type among those included in the database.

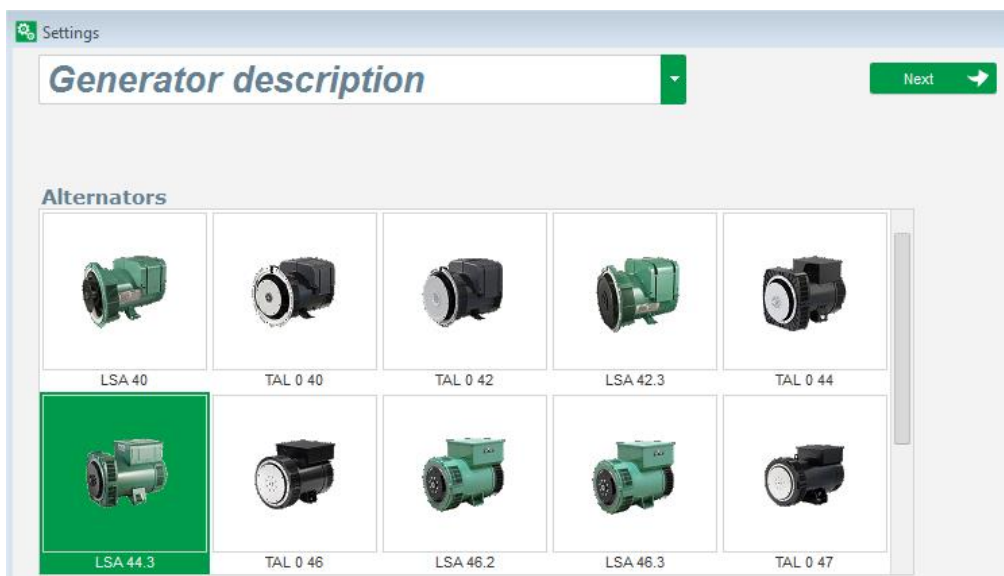





NOTE: Double click on the picture to continue the configuration process.

D350

Digital Voltage Regulator

3.1.6.2. Step 2: Definition of the alternator features

LSA 44.3	TAL 0 46	LSA 46.2	LSA 46.3	TAL 0 47
				
Length	L10			
Excitation type	AREP			
Nominal frequency (Hz)	50.0			
Number of stator outputs	12 wires			
Stator connection diagram	CONNECTION: D			
Rated voltage (V)	400			
Service T°C/Class T°K	H / 125°K			

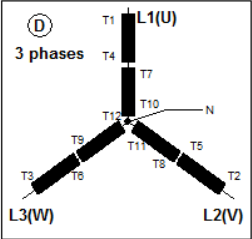

3 phases

Select the alternator core length

- Define the excitation type (AREP, SHUNT or PMG)
- Select the frequency and the connection diagram. The right side picture is updated according to the user's selection
- Selection the rated voltage and the thermal class
- Then click on « Next »

3.1.6.3. Step 3: Wiring

Settings

Wiring

Generator PT
Generator voltage connection

1: 2 Ph (V-V)
 0: 2 Ph (U-W)
 1: 2 Ph (V-V)
 2: 3 Ph (U-V-W)

Generator CT

Global CT ratio

Primary (A)

Secondary (A)

Phase shift (°)

Temperature probe(s)

Grid/Load

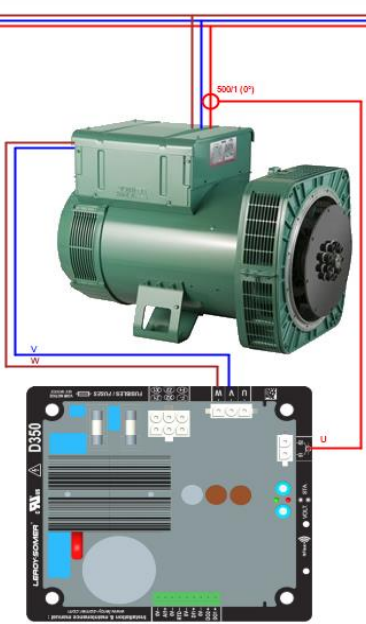

D350

Digital Voltage Regulator

When a PT is used: Tick the « Alternator PT » box and fill the primary and the secondary of the voltage transformer.

When a CT is used: Tick the « Alternator CT » box and fill the primary and the secondary of the current transformer.

3.1.6.4. Step 4: Regulation mode selection

The screenshot shows the 'Regulation mode' settings window. The 'Voltage' tab is selected. The 'Regulation enabled by' dropdown is set to 'Always enabled'. The 'Setpoint from internal potentiometer' is selected and set to 'Active'. The 'Underspeed' section shows a knee of 48.0 Hz and a slope of 1.0 V/Hz. The 'Reactive droop compensation (%)' is set to 3.0. The 'Typical Underspeed Curve' graph shows a linear increase in voltage from 0V at 0 Hz to 400V at 48 Hz, then a constant voltage of 400V up to 90 Hz. The 'Reactive Droop Curve' graph shows three curves of voltage (U) vs. reactive power (Q) at 100% load. The curves are labeled with values 514, 388, and 291 at 100% Q.

Voltage regulation: The box is ticked by default. Adjust the voltage setpoint if necessary.

Reactive droop compensation: When a CT is connected this function can be activated and its value adjusted.

Soft Start duration: This function can be used to ensure a smooth voltage build up.

D350

Digital Voltage Regulator

3.1.6.5. Step 5: Configuration upload

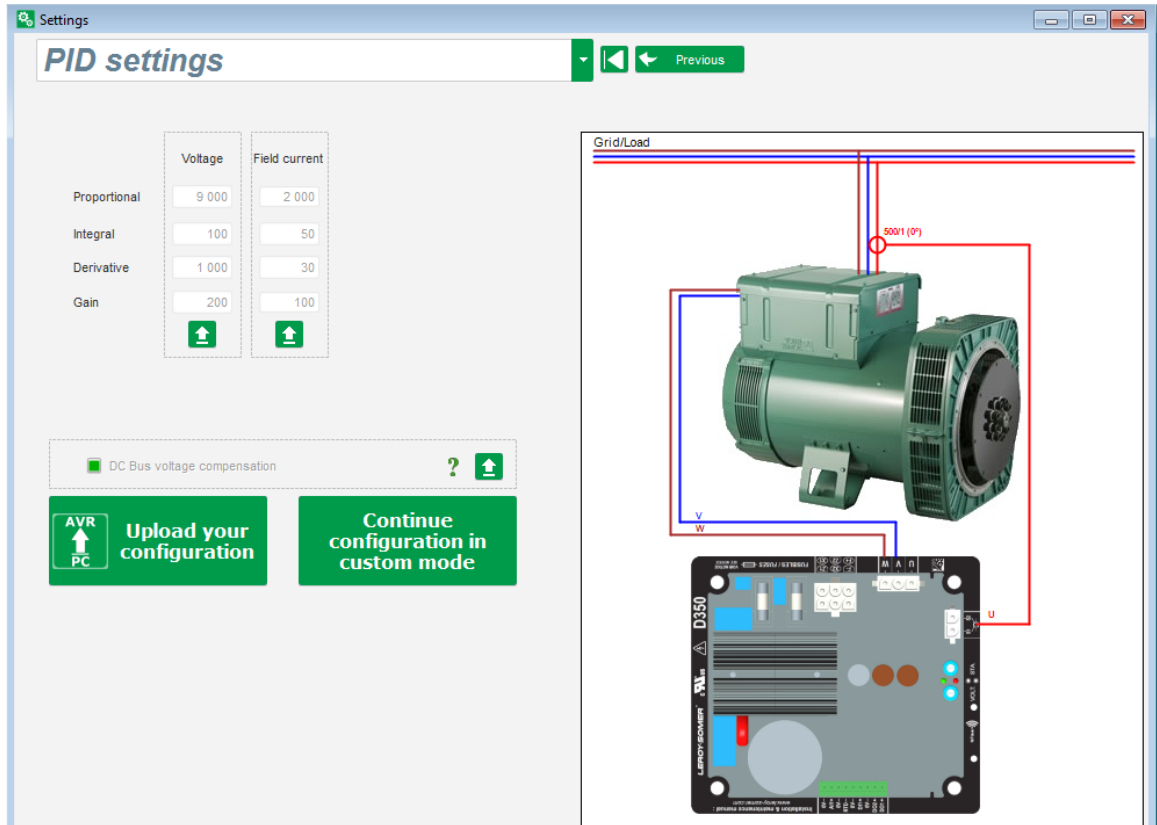

Click on « **Upload your new configuration** » to upload the configuration into the regulator. In that case, the not filled parameters will be completed thanks to the Easyreg Advanced database.

When clicking on « **Continue the configuration in custom mode** », the user will access to a configuration mode which contains all the parameters menus initialized with the values that were defined on quick configuration mode.

3.1.7. Create a new configuration in custom mode

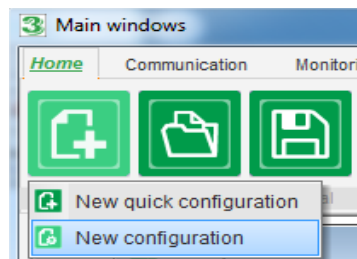

Click on "New configuration":

NOTE: As previously shown, it is possible to also access to this mode at the end of the Quick configuration.

D350

Digital Voltage Regulator

The sequence of configuration steps is shown in the diagram below:

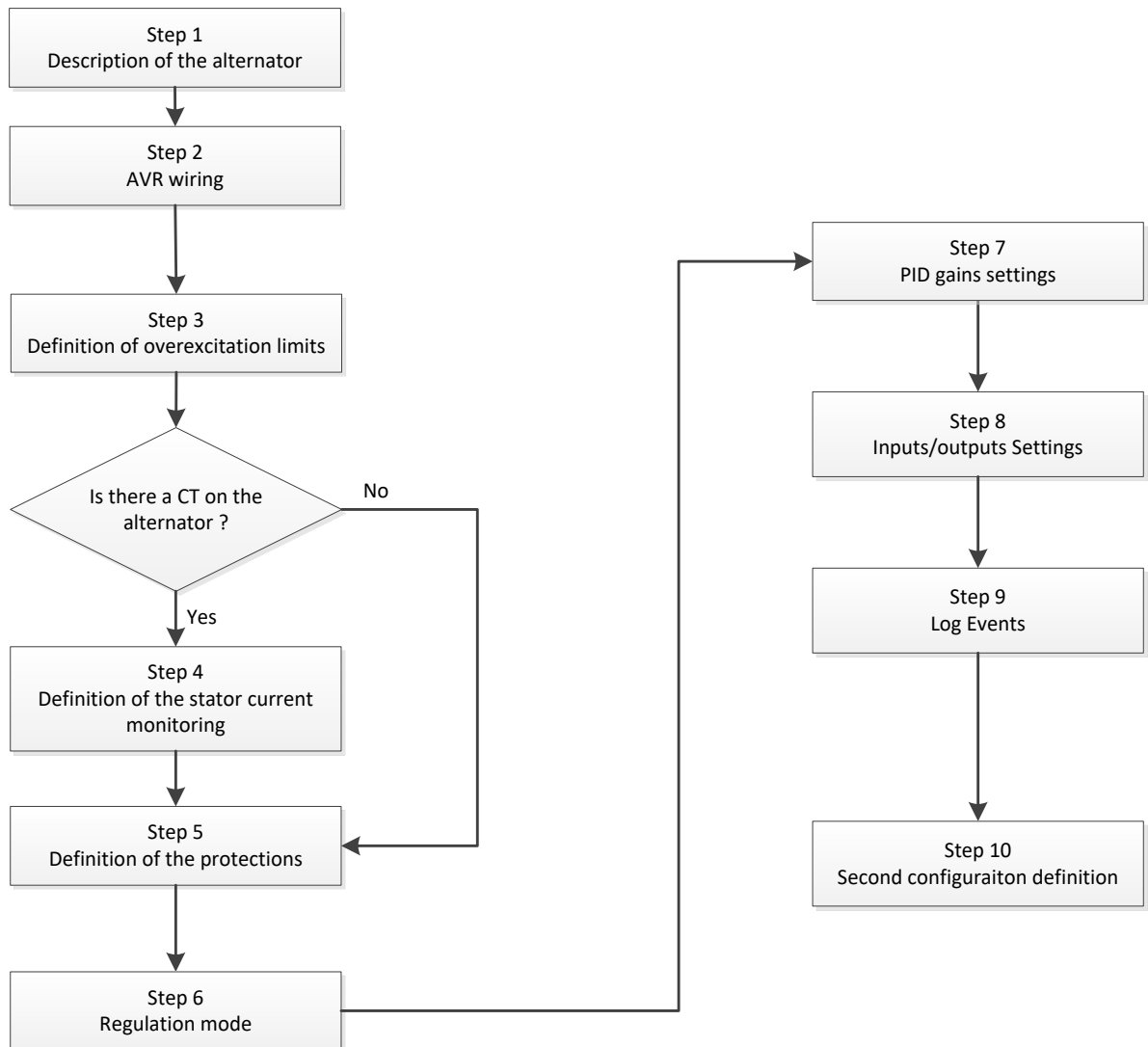

3.1.7.1. Step 1: Description of the alternator

- Describe all the alternator characteristics: voltage (in Volts), apparent power (in kVA), frequency (in Hz), and power factor.
- Fields: rated current, reactive power and active power are calculated automatically.

Generator data	
Rated voltage (V)	400,00
Rated frequency (Hz)	50,00
Rated power factor	0,80
Rated apparent power (kVA)	296,00
Rated nominal power (kW)	236,80
Rated reactive power (kVar)	177,60
Rated current (A)	427,24

D350

Digital Voltage Regulator

- Describe all the field excitation characteristics: exciter field resistance (in ohms), shutdown field current (in Amps), and rated field current (in Amps).

Excitation data

Field inductor resistance (Ohms)	<input type="text" value="15,54"/>
Shutdown Field current (A)	<input type="text" value="0,50"/>
Rated field current (A)	<input type="text" value="3,21"/>

- Click on the “Next” button

3.1.7.2. Step 2: AVR wiring

This wiring must be typical of the connections between the AVR and the alternator. As your configuration develops, the wiring diagram in the right site window changes as well: representation of VT and/or CT, number of conductors, etc.

- Alternator voltage measurement VTs:**

- If these are present, tick the box. The various parameters can then be set
- State the primary and secondary winding voltages (in Volts)
- State the type of measurement: phase-to-phase, 3 phases

Generator PT Generator voltage connection

Primary (V): Secondary (V):

- Alternator current measurement CT:**

- If it is present, tick the box. The various parameters can then be set.
- State the primary and secondary winding current (in Amps).

Generator CT

Primary (A) Secondary (A) Phase shift (°)



Generator CT

Sensing

Primary (A)

Secondary (A)

Isolation CT

Primary (A) Secondary (A)

Results

Primary (A) Secondary (A)

Valider Annuler

D350

Digital Voltage Regulator

NOTE:

- The phase shift value should be set during tests and commissioning. It is used to compensate for the phase difference caused by the CT and VTs.
- When the CT only measures part of the generator total current, the advanced CT configuration mode must be used to complete the configuration.

3.1.7.3. Step 3: Definition of the over excitation limit

- This limit is divided into 3 different parts using 3 points which define the areas. These points are determined according to the machine capability. The default adjustment values are:
 - Twice the rated field current for 10 seconds for the stator short-circuit
 - 1.5 times the rated field current for 10 seconds for 120 seconds
 - 1.1 times the rated field current for 10 seconds for 3600 seconds
- As soon as the field current exceeds the value of the rated current, a counter is triggered. The S1 “field current measurement x time” area (shown in red below) is then compared with the “maximum field current x time” area (shown in blue below). If S1 equals S2, the limit is active and the D350 limits the field current to 99% of the rated current (which in this case results in the regulation mode in progress reference not being tracked).

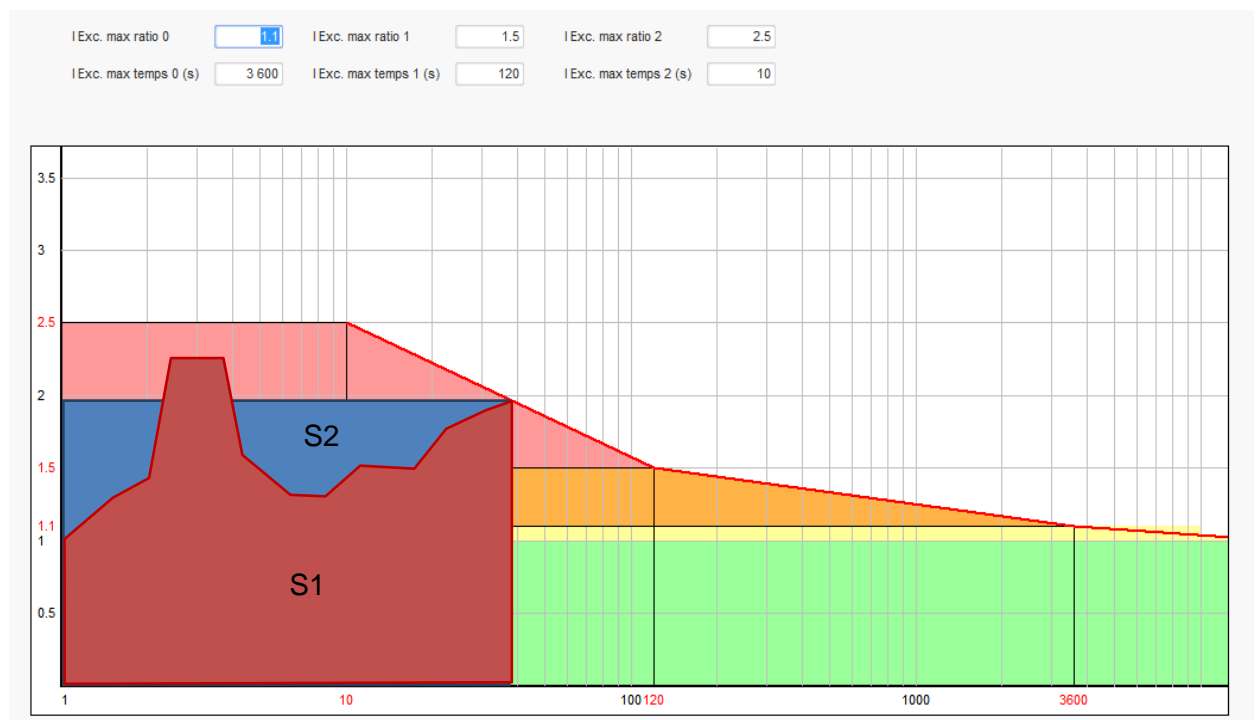

- If the limit is active, in order to protect the machine, it is only possible to have a current higher than 99% of the rated current after 24 hrs.
- Click on the "Next" button.

D350

Digital Voltage Regulator

3.1.7.4. Step 4: Definition of stator current monitoring

- This monitoring can only be enabled in voltage regulation mode and with a CT configured to measure the stator current. If no CT is configured then got to Step 5.
- It is divided into 3 different parts using 3 points which define the areas. These points are determined according to the machine capability. The default adjustment values are:
 - Three times the rated stator current for 10 seconds for the stator short-circuit
 - 1.5 times the rated stator current for 120 seconds
 - 1.1 times the rated stator current for 3600 seconds
- As soon as the stator current exceeds the value of the rated current, a counter is triggered. The S1 “stator current measurement x time” area (shown in red below) is then compared with the “maximum stator current x time” area (shown in blue below). If S1 equals S2, the limit is active and the D350 enables “overcurrent” fault and the red LED is flashing to indicate abnormal operation.

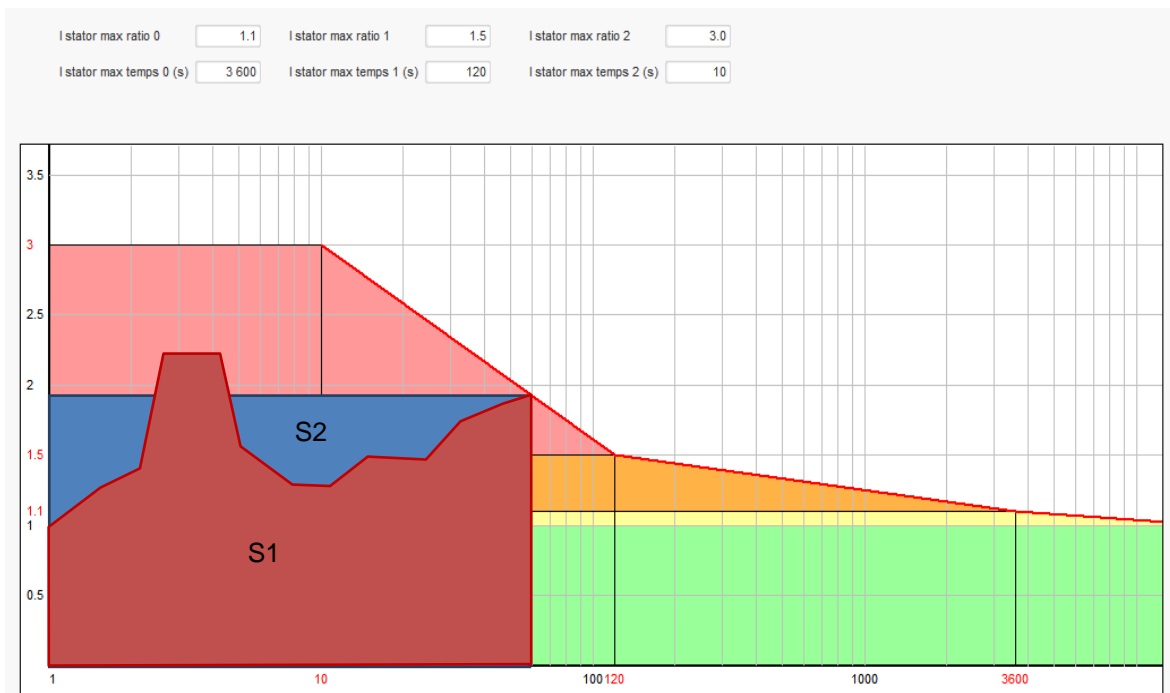

- Click on the "Next" button

3.1.7.5. Step 5: Definition of the protections

There are 3 types of protection devices:

- Generator faults
- Regulator faults
- The alarm and trip thresholds for the temperature sensor

All protections have the same architecture:

- An activation of the protection
- A threshold
- A delay

D350

Digital Voltage Regulator

- An action to realize (or not) when the delay is over. This action is chosen in a list:
 - No action: the regulation will continue
 - Regulation stopped: the excitation is then stopped
 - Regulation in field current mode at shutdown value
 - Regulation in field current mode at the field current value before fault: no bump in the regulation

Each protection has an auto-reset option:

- If this option is selected: if fault disappears, regulation will return to the automatic mode (voltage mode, or excitation current)
- If this option is not selected, the chosen action is maintained

Below is an example for overvoltage:

Over voltage fault detected

Activation
 Overtoltage % setpoint
 Auto-Reset

Overtoltage delay
 Action after fault

On activation of this fault, background becomes light green.

Over voltage fault detected

Activation
 Overtoltage % setpoint
 Auto-Reset

Overtoltage delay
 Action after fault

- **Under voltage and overvoltage:** These protections can be enabled by ticking the checkboxes "Activation" and defining a threshold (in percentage of the rated voltage) and a delay before the activation of the protection. In the case below:
 - Under voltage fault is activated if the generator voltage is less than 85% of the rated voltage for at least 1 second. This fault is active only if the regulation is enabled and the soft start ramp achieved.
 - Overtoltage fault is active if the generator voltage is higher than 115% of the rated voltage and for at least 1 second.

Under voltage fault detected

Activation
 Undervoltage % setpoint
 Auto-Reset

Undervoltage delay
 Action after fault

Over voltage fault detected

Activation
 Overtoltage % setpoint
 Auto-Reset

Overtoltage delay
 Action after fault

- **Under frequency and over frequency:** These protections can be enabled by ticking the checkboxes "Activation" and defining a frequency value and a delay before the activation of the protection. In the case below:
 - Under frequency fault is activated if the generator frequency is less than 45Hz for at least 5 seconds. This fault is active only if the regulation is enabled.
 - Over frequency fault is active if the generator frequency is higher than 55Hz for at least 5 seconds.

D350

Digital Voltage Regulator

Under frequency fault detected

Activation Underfrequency setpoint Auto-Reset

Underfrequency delay Action after fault

Over frequency fault detected

Activation Overfrequency setpoint Auto-Reset

Overfrequency delay Action after fault

- **Start motor fault:** This protection can be enabled by ticking the checkbox "Activation" and defining a delay. In the case below, fault is activated if the generator voltage is less than the voltage setpoint when the 30 second delay is complete.

Motor start fault detected

Activation Motor start delay Auto-Reset

Action after fault

- **Loss of sensing:** this protection can be enabled by ticking the checkbox "Activation" and defining a voltage threshold in percentage of the generator voltage setpoint, as well as a delay before activation of the protection device. In the case below, the trip is active if the generator voltage is less than 20% of the voltage setpoint after 1 second.

Loss of sensing fault detected

Activation Lost of sensing % Auto-Reset

Lost of sensing delay Action after fault

- **Unbalance voltage:** this protection can be enabled by ticking the checkbox "Activation" and defining a percentage of voltage unbalance as well as a delay before activation of the protection device. Calculation of the voltage unbalance is according to the NEMA standard:

$$\text{Unbalance percentage} = \frac{\text{Maximum generator voltage}}{\text{Average of generator voltage}} \times 100$$

In the case below, this fault is activated if the percentage of unbalance is at least 20% after 1 second.

Unbalanced voltage fault detected

Activation Unbalanced voltage % Auto-Reset

Unbalanced voltage delay Action after fault

- **Short-circuit:** this protection can be enabled by ticking the checkbox "Activation" and defining a minimum stator current threshold in percentage of the generator rated current, as well as a delay before activation of the protection device. In the case below, the trip is active if the generator current measurement is higher than 200% of the rated stator current after 10 seconds.

Short circuit fault detected

Activation Short circuit nominal stator current % Auto-Reset

Short circuit delay Action after fault

D350

Digital Voltage Regulator

- **Temperature protection:** these protections can be enabled by ticking the checkbox "Activation" and defining the trip and alarm temperature thresholds. The screenshots below give an overview for a PT100 and a PTC.

PT100 fault

Activation

PT100 alarm temperature (°C) Auto-Reset

PT100 temperature fault (°C) Action after fault

PTC fault detected

Activation

PTC Value (Ohm)

1 PTC Auto-Reset

3 PTC (serial)

Custom Action after fault

On the last page of the protections, are defined groups of faults. All the faults can be then put altogether and assigned to one digital output for example. In the example below group 1 corresponds to the faults linked to the voltage and group 2 is relative to frequency ones.

Fault	Group 1	Group 2
Overvoltage fault class	<input checked="" type="checkbox"/>	<input type="checkbox"/>
Undervoltage fault class	<input checked="" type="checkbox"/>	<input type="checkbox"/>
Overvoltage fault class	<input type="checkbox"/>	<input checked="" type="checkbox"/>
Underfrequency fault class	<input type="checkbox"/>	<input checked="" type="checkbox"/>
PT100 fault class	<input type="checkbox"/>	<input type="checkbox"/>
PT100 KO (Open or Short Circuit) fault class	<input type="checkbox"/>	<input type="checkbox"/>
PTC fault class	<input type="checkbox"/>	<input type="checkbox"/>
Loss of sensing fault class	<input checked="" type="checkbox"/>	<input type="checkbox"/>
Short circuit fault class	<input type="checkbox"/>	<input type="checkbox"/>
Unbalance voltage fault class	<input checked="" type="checkbox"/>	<input type="checkbox"/>
Motor start fault class	<input type="checkbox"/>	<input type="checkbox"/>
Power bridge overload fault class	<input type="checkbox"/>	<input type="checkbox"/>

- Click on the "Next" button

3.1.7.6. Step 6a: Setting of the voltage soft start

A controlled voltage build up is done through the soft start and the start on threshold functions.

Start-up Voltage Field Current

Ramp delay (s)

Supply initial PWM (%) ?

Start on threshold

Start on Threshold (SoT) Mode Active

Voltage Threshold (V)

Initial PWM SoT (%) ?

D350

Digital Voltage Regulator

- The **Ramp delay** corresponds to the time duration to reach the voltage setpoint (or the excitation current setpoint) of the generator. If no soft start is needed this value must be set to "0".
- The **Supply initial PWM** allows to correctly initialize the microcontroller and internal supplies of the regulator. The default value is 25%, but can be adjusted according to the excitation system and the type of the generator.
- **Start on Threshold** allows a master of the voltage build up. The initial PWM is the ratio of available Voltage (rectified from the excitation AC supply) that is applied to the exciter stator until the voltage has reached the predefined voltage threshold. In the example above the threshold is 100V and the percentage is 5%. The different steps of the function are described in the figure hereafter.

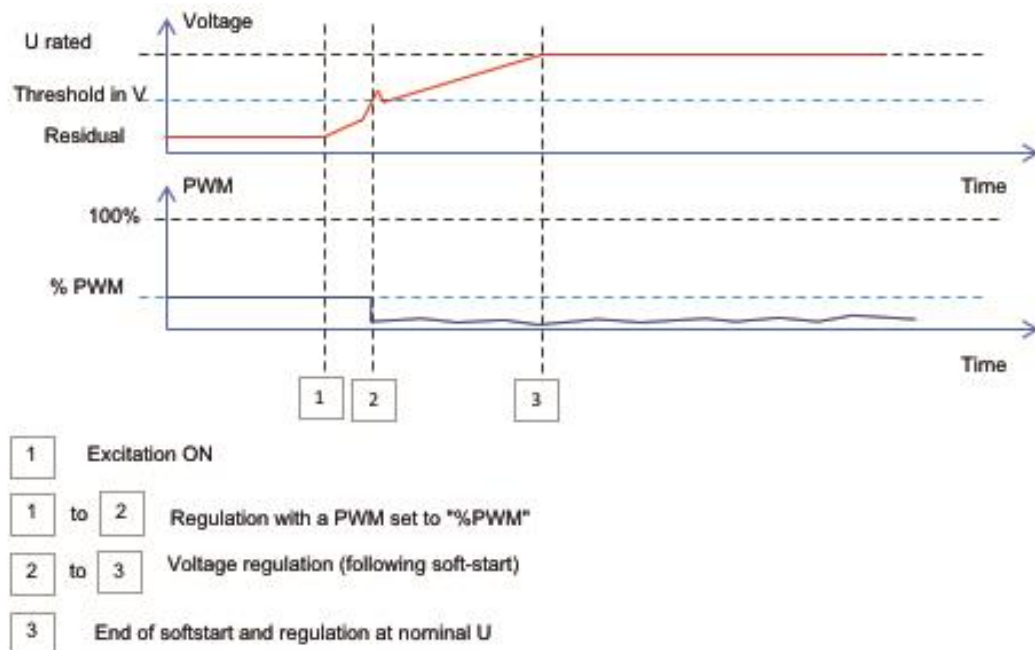

Example: threshold=100V; voltage setpoint =400V and Softstart=10s → when the threshold « 100V » is reached, the regulator will take additional 7.5s ($=10s \cdot (400-100)/400$) time to reach the desired voltage setpoint.

- Click on the "Next" button

3.1.7.7. Step 6b: Voltage regulation

- The **Setpoint source** is determined by the drop-down list: via a fixed value in the configuration, or by an analog input with a range to be determined or by internal potentiometer.

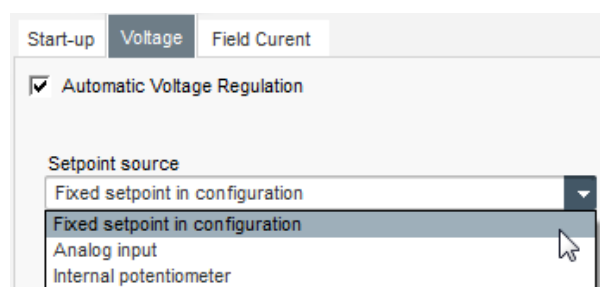

D350

Digital Voltage Regulator

- If the “Analog input” option is selected, the “Reference via analog input” part is enabled further down. Select the desired analog input box, determine its mode (0/10V or potentiometer) and the voltage values at 0% and 100%.

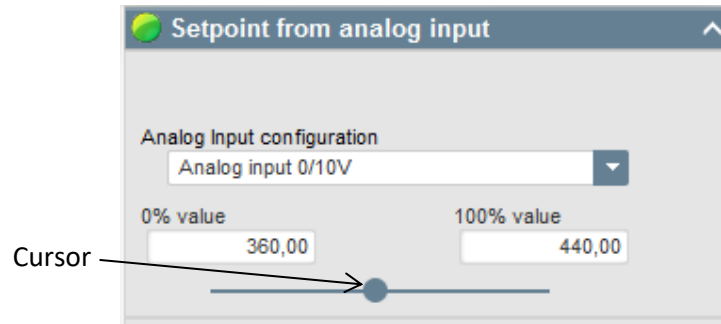

NOTE: By moving the cursor, it is possible to view the values obtained on the voltage and under frequency curves displayed on the right.

- **The limits of this setpoint** should be fixed, depending on the machine capability (in the example below, the minimum voltage reference is 90% of 400 V (i.e. 360 V), and the maximum voltage reference is 110% of 400 V, (i.e. 440 V).

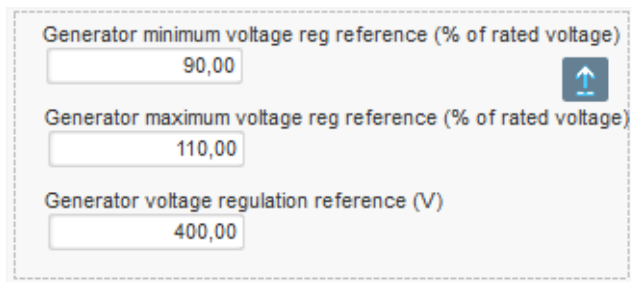

- If «internal potentiometer» option is selected, the page "Setpoint from internal potentiometer" is enabled further down. The voltage levels at 0% and 100% must then be entered.

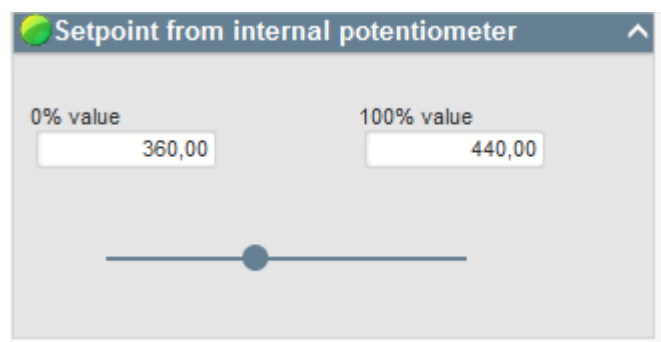

D350

Digital Voltage Regulator

- **When fixed setpoint or internal potentiometer is used** it is possible to combine with voltage bias through the analog input AI1:

With setting above, if the voltage setpoint is 400V, the output voltage will range from 350V to 450V when the voltage on AI1 will vary from 0 to 10V.

- **Underfrequency:** These two fields are used to set the voltage drop as a function of the alternator speed.
- **Knee-point value:** The typical values are 47.5 Hz for an alternator at 50 Hz, 57 Hz for an alternator with 60 Hz rated frequency and 380 Hz for an alternator at 400 Hz.
- **Slope:** Adjustable from 0.5 to 3. The higher the slope value, the greater the voltage drop will be if the drive motor speed drops.

- The curve drawing changes as a function of these two values.

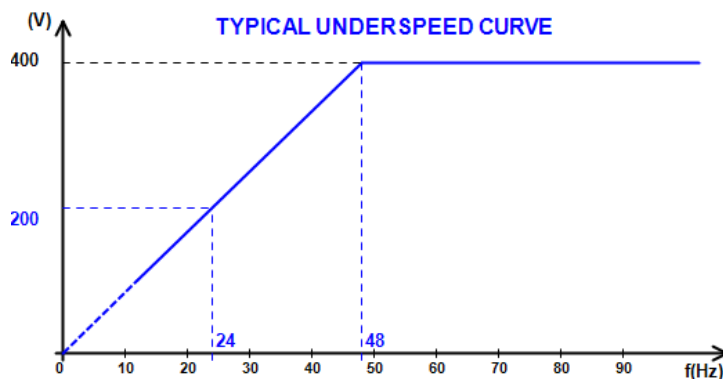

- **Reactive droop compensation:** Select the box to enable this and give a voltage drop percentage between -20% and +20% (caution, a negative value corresponds to an increase in voltage). This function is mainly used in the case of alternators operating in parallel with one another. This value is set to 3% by default.

D350

Digital Voltage Regulator

The quadrature droop curve drawing changes as a function of the voltage setpoint.

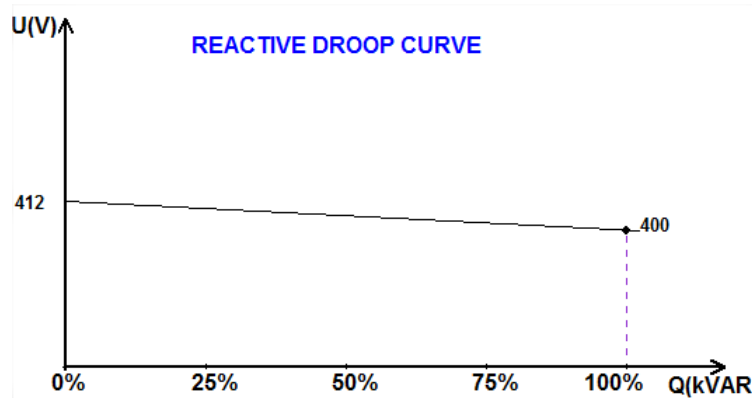

NOTE: If quadrature droop has been enabled, it is no longer possible to have line droop compensation.

- **Line droop compensation:** Select the box to enable this and give a voltage reference change percentage between -20% and +20%. This function is mainly used, depending on the kVA delivered by the machine, to:
 - Increase the voltage reference in the case of particularly lengthy distribution lines.
 - Decrease the voltage reference (with a percentage down to -20%) to balance the loads for machines connected to a rectifier (DC bus).

Voltage line droop compensation (%)

The compensation curve drawing changes as a function of the voltage setpoint.

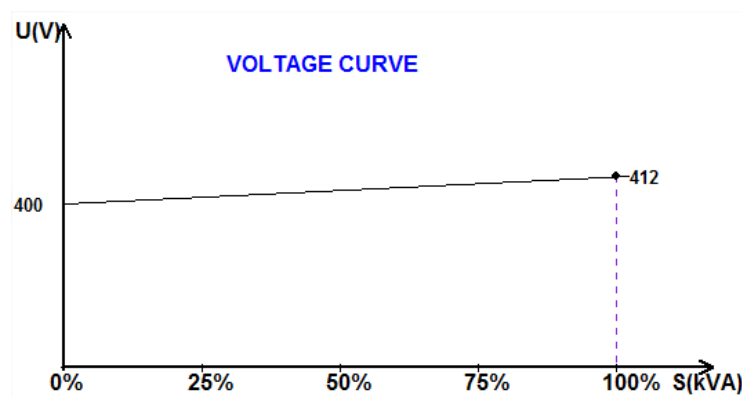

NOTE: If load compensation has been enabled, it is no longer possible to have quadrature droop.

- **Motor start:** Select the box to enable the starting motor function, and give a percentage of rated stator current. This function is active only in voltage regulation mode and allows limiting the stator current at a defined value.

Motor start (% I_{Stator nom})

D350

Digital Voltage Regulator

When the breaker is closed between the motor and the generator, the D350 continues to regulate the voltage until the stator current measured reaches the limitation value. In this case, the D350 regulates the stator current. When the motor reaches its rated speed, the current will decrease naturally and the voltage will increase. The D350 will then return to voltage regulation mode.

To prevent and detect a possible bad motor starting event, a delay can be set between 1s to 60s in the protections page. If the voltage is not at its voltage setpoint when the delay is over, the regulator will then respond based on the chosen action, as for all the others fault:

- No action
- Stop the regulation
- Field current regulation mode at shutdown value
- Field current regulation mode at value before the fault

If the motor breaker is closed before energizing, this limitation has the priority and ramp time is not respected.

NOTE: During the motor starting, all the other limitations, faults and protections (under voltage, over voltage, stator monitoring, under speed, under excitation, over excitation) are active.

- **LAM: Load Acceptance Module**

This function improves the generator response reducing the voltage setpoint on load impacts. When generator frequency measured is below the under-speed knee defined in the configuration (example 48Hz or 58Hz), voltage setpoint is decreased to a defined value (in example below, 10% under the rated voltage).

<input checked="" type="checkbox"/> Soft voltage recovery (s/%)	0.1
<input checked="" type="checkbox"/> L.A.M. (%)	
Attenuation coeff of nominal voltage (%)	10.0
Frequency stabilisation delay (ms)	50

- If frequency continues to fall, the voltage is regulated according to the U/f law.
- Soft voltage recovery helps the speed recovery of the group: it is given in seconds per percent of the rated voltage (s/%). For example, the above setting means that if the frequency decreases by 10% then the progressive rise time will be 1 second (i.e. $0.100s / \% * 10\%$). Note: that if the slope of progressive rise is greater than the U/f law, then the latter will be used to raise the voltage.
- The frequency stabilization delay corresponds to the waiting time before the voltage setpoint is raised gradually (according to the increase of the frequency).

D350

Digital Voltage Regulator

- The figure below shows the operating details of the LAM.

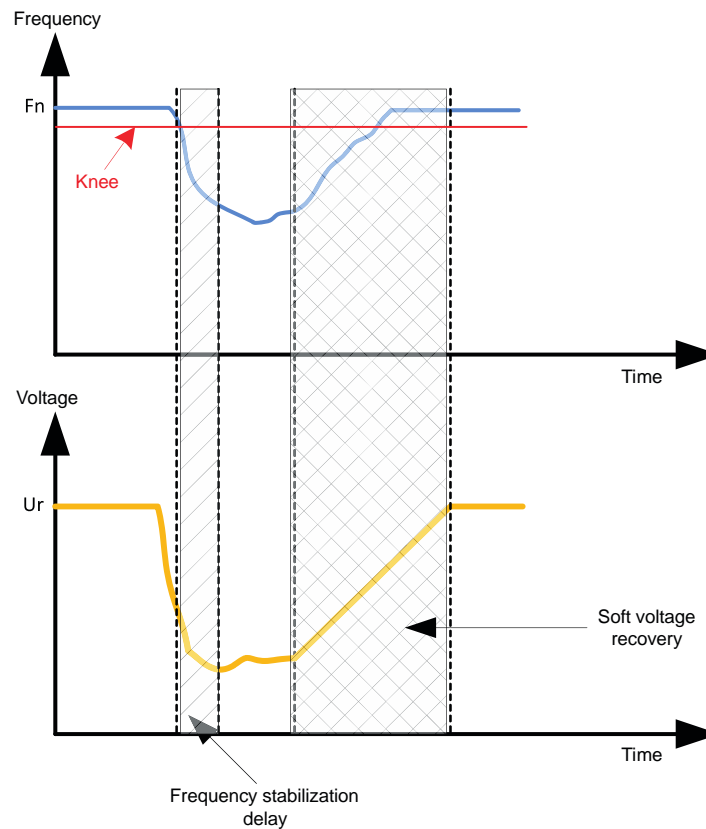

- Self-adaptive LAM:** it has the same role as the classical LAM described above. The difference lies in the fact that the percentage of voltage drop is no longer fixed by the user but is automatically adapted to the level of the load impact. Thus for each load impact:
 - The controller measures the operating frequency and calculates its derivative permanently.
 - From this derivative value, an attenuation coefficient (K) of the voltage is calculated according to the parameters configured by the user. In the example below, for a frequency variation of 10Hz/s, the applied voltage drop will be 10% of the nominal voltage.

Self-adaptive LAM (%)

Reaction speed coefficient (Hz/s)

Attenuation coeff of nominal voltage (%)

Frequency stabilisation delay (ms)

For each load impact, the voltage attenuation is determined by the formula $\Delta U = K \cdot U_r$ where U_r is the rated voltage of the alternator.

The frequency stabilization delay corresponds to the waiting time before the voltage setpoint is raised gradually (according to the increase of the frequency).

- Click on the "Next" button

D350

Digital Voltage Regulator

3.1.7.8. Step 6c: Regulation of the field current (Manual mode)

- This regulation is used to control the value of the field current directly. It is mainly used during commissioning or as fallback mode if a measurement is incorrect on the AVR (alternator voltage measurement or alternator current measurement for example).
- It takes priority over the voltage regulation mode.

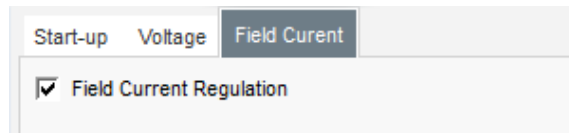

- **The home reference point** is determined by the drop-down list:
 - By a fixed value in the configuration.

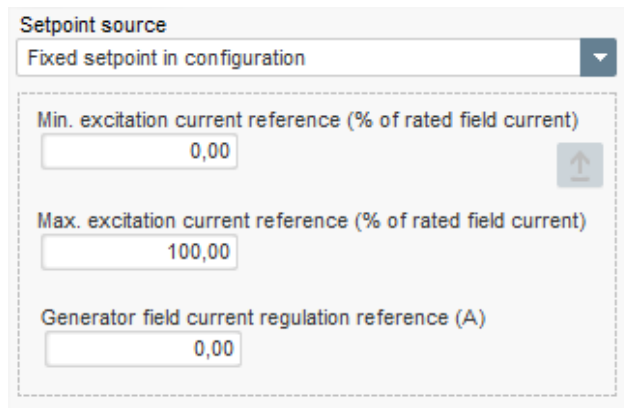

- By an analog input with a range to be defined.

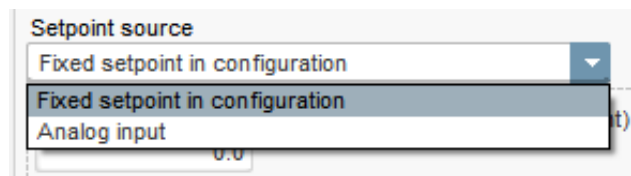

D350

Digital Voltage Regulator

- If the “Analog input” option is selected, the “Setpoint from analog input” part is enabled further down. Select the desired analog input box, determine its mode (0/10 V or potentiometer) and the excitation current values at 0% and 100%.

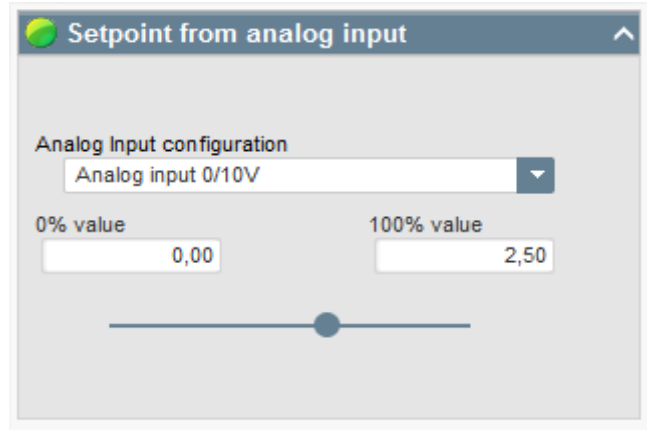

NOTE: By moving the cursor, it is possible to view the field current reference (blue line) on the graph located on the right of the shape.

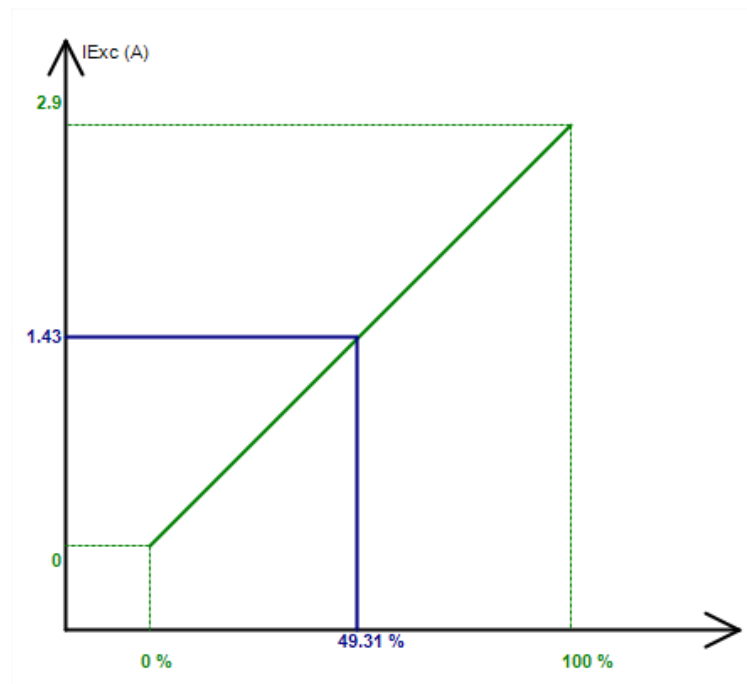

- The “Follower mode” function, when switching from a regulation mode to manual mode, allows the field current measurement to be used as a reference. This prevents any visible “jumps” on the machine output voltage.



D350

Digital Voltage Regulator

3.1.7.9. Step 7: Setting the PID gains

- In quick configuration mode, all PID parameters are set automatically as shown below.

	Voltage	Field current
Proportional	9 000	2 000
Integral	100	50
Derivative	1 000	30
Gain	200	100

According to the applications, these factory settings can be tuned to reach the desired performances on the generator.

- If a shunt or AREP type field is being used, the power supply voltage depends directly on the voltage at the alternator terminals. As a result, it can fluctuate with the load and therefore influence the PID's behavior. To compensate for these fluctuations, it may be advisable to select the "VBus compensation" box. Below is an example of ramp starting with and without compensation in the case of a shunt field:

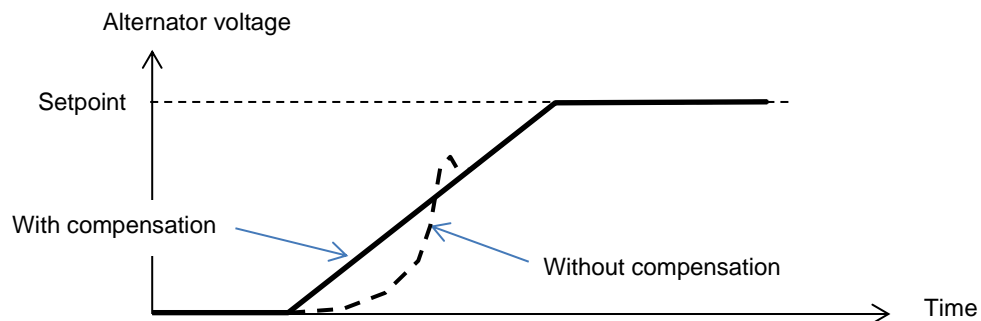

- In the case of induction motor starting, the Current limitation gain must be adjusted to ensure a stable regulation of the excitation current during this limitation stage.

<input checked="" type="checkbox"/> DC Bus voltage compensation
Current limitation gain <input type="text" value="5"/>

- Click on the "Next" button

D350

Digital Voltage Regulator

3.1.7.10. Step 8: Inputs and outputs management

- Go to the I/O page.

The screenshot shows the 'Settings' interface for the D350 Digital Voltage Regulator, specifically the 'Inputs/Outputs' configuration page. The page is titled 'Settings *' and 'Inputs/Outputs'. It features several configuration sections:

- Analog Input:** Includes 'Analog Input configuration' (set to 'Analog input 0/10V'), '100% value' (0,00), '0% value' (0,00), and 'Analog Input destination' (set to 'None').
- PT100/PTC Input:** Includes 'Type of temperature sensor' (set to '0: PT100').
- Digital Input:** Includes 'DI1 Active Logic' (set to 'Active low') and 'Digital Input destination' (set to 'None').
- Digital Outputs:** Includes 'Digital Output source DO1' (set to 'None'), 'DO1 Active Logic' (set to 'Active low'), 'Digital Output source DO2' (set to 'None'), and 'DO2 Active Logic' (set to 'Active low').
- Internals potentiometers:** Includes two sets of radio buttons for 'None', 'Reactive droop (%Voltage reference)', and 'Voltage regulation overall gain'. Each set has 'Upper value' and 'Lower value' fields (both set to 0,00). A photograph of the physical potentiometers on the device is shown on the right.

- **The digital outputs** can be configured by defining the source, the activation (active low = closed if the condition is fulfilled, “active high” = output open if the condition is satisfied).
- **The assignment of internal potentiometers** is done on this page.

D350

Digital Voltage Regulator

3.1.7.11. Step 9: Log Event

Event Type	Event Counter	I Exc. during the last event
<input checked="" type="checkbox"/> Short-circuit	0	0,00
<input type="checkbox"/> Under voltage	0	0,00
<input type="checkbox"/> Over voltage	0	0,00
<input type="checkbox"/> Unbalance voltage	0	0,00
<input type="checkbox"/> Loss of sensing	0	0,00
<input type="checkbox"/> Underspeed	0	0,00
<input type="checkbox"/> Over frequency	0	0,00
<input type="checkbox"/> Main field overload	0	0,00
<input type="checkbox"/> Main field overheating	0	0,00
<input type="checkbox"/> Stator overload	0	0,00
<input type="checkbox"/> Stator overheating	0	0,00
<input type="checkbox"/> PT100 alarm	0	0,00
<input type="checkbox"/> PT100 Fault	0	0,00
<input type="checkbox"/> PTC Fault	0	0,00
<input type="checkbox"/> Fault motor start	0	0,00

For each selected event, the corresponding counter will be increased anytime it appears and the excitation current is recorded.

D350

Digital Voltage Regulator

3.1.7.12. Step 10: The Second Configuration

This function is usually known as the “50/60Hz switch function”, but it offers much more features and flexibilities.

Parameter	Value	Destination
Parameter 1 value	58,000	V/Hz knee frequency
Parameter 2 value	480,000	Generator voltage regulation reference
Parameter 3 value	1,500	V/Hz slope
Parameter 4 value	0,000	None
Parameter 5 value	0,000	None
Parameter 6 value	0,000	None
Parameter 7 value	0,000	None
Parameter 8 value	0,000	None
Parameter 9 value	0,000	None
Parameter 10 value	0,000	None
Parameter 11 value	0,000	None
Parameter 12 Value	0: 2 Ph (U-W)	Generator voltage connection
Parameter 13 Value	0: No	Threshold Start
Parameter 14 Value	0: 0/10V	AIN1 Configuration
Parameter 15 Value		None
Parameter 16 value		None

- **Activate** the Second configuration.
- **Select the parameters** which will be affected when switching to that second configuration. In the example above, we define a new frequency knee at 58Hz, a new voltage setpoint at 480V, the V/Hz slope is set to 1.5 and the voltage sensing is now done on the 3 phases of the generator.
- **Back to the I/Os page**, ones will see that the digital input DI1 is now assigned to that second configuration.

Parameter	Value
DI1 Active Logic	Active low
Digital Input destination	Second configuration enable

The activation of DI1 leads to the switching to the second configuration and its deactivation bring back the regulation to the base configuration.

NOTE: The switch is only taken into account at the regulation starting. Any activation or deactivation when the regulator is in operation will be ignored.

D350

Digital Voltage Regulator

3.1.8. “Oscilloscope” window

This window is used to trace the values of up to 8 parameters simultaneously.

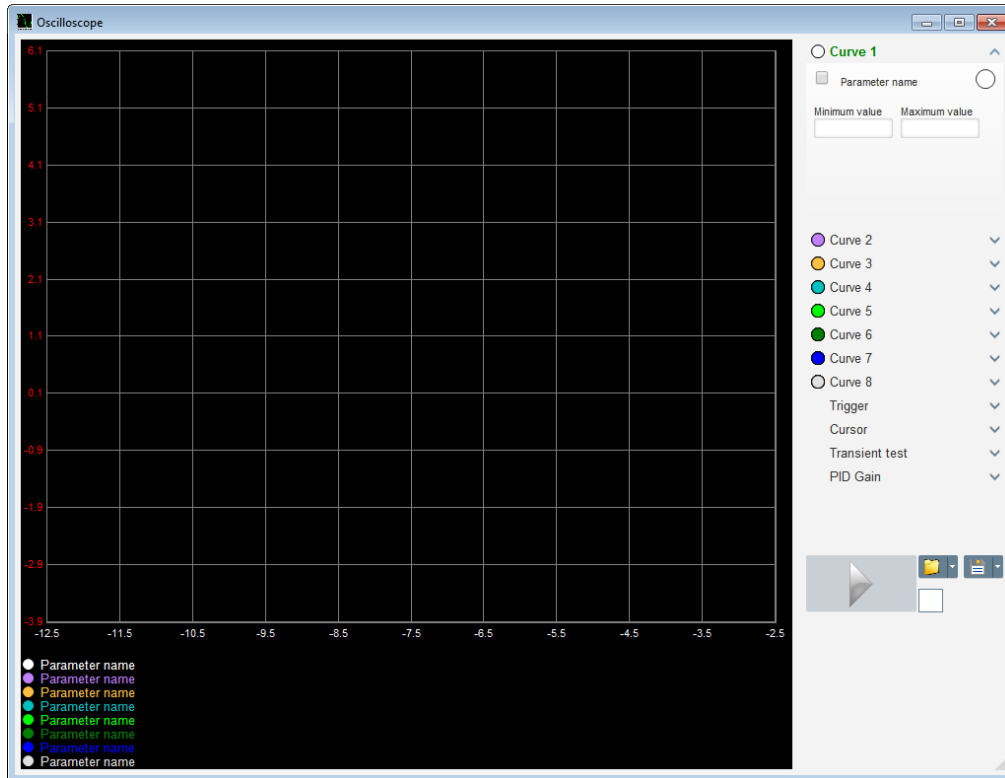

3.1.8.1. Curves

Each curve is described by: its color, its source parameter, its minimum and maximum values. It has its own axis, which is the same color as the curve.

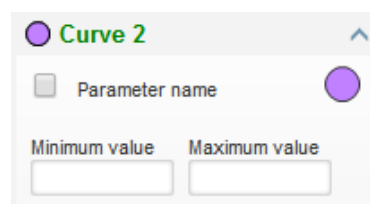

- **To change the color:**
 - Click on the colored disk to the right of the curve name, and a predefined palette will open.



- Click on the new curve color from those available.
- The color selection window is then automatically closed, and the disk then takes on its selected color.

D350

Digital Voltage Regulator

- Should you wish to configure a color not in the palette, click on the “Other colors...” button. The palette is then transformed. Move the black cross to the selected color or fill in the text boxes (each value between 0 and 255) to define the RGB color values. Then click “OK”.

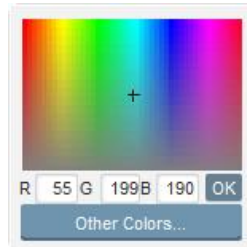

NB: When you no longer wish to change the color, just click outside the palette. It will close automatically.

- **Select a parameter to plot**
 - Click on the tick box.
 - If the box was already selected, a confirmation message appears. On clicking “Yes”, a window opens with the list of parameters.

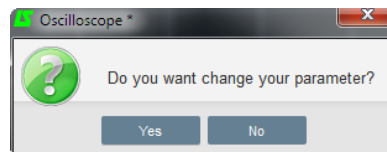

- If the box was not already selected, the window with the list of parameters opens directly.
- Select the parameter you wish to track from the drop-down list. This parameter can be an analog or digital value (regulation mode for example).
- Click “OK” to use the selected parameter, or “Cancel” if you don't wish to change anything.

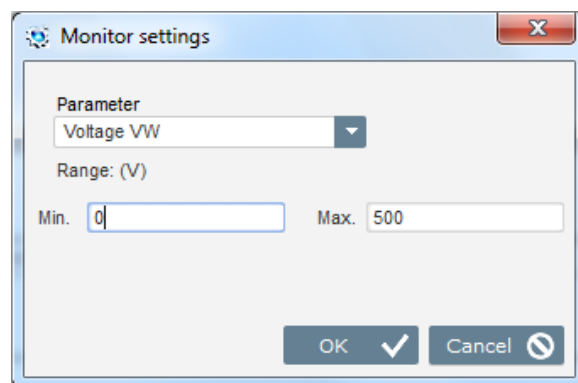

- **Refine the plotting range:** change the minimum and maximum values if necessary. These values are taken into account and the trace is re-scaled as soon as one of the boxes is exited or the keypad “Enter” key is pressed.

D350

Digital Voltage Regulator

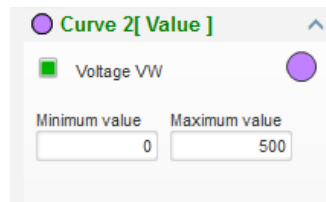

When the monitor is on, the current value appears in square brackets.

3.1.8.2. Trigger

The trigger is used to launch oscilloscope operation once the chosen parameter value exceeds the value entered either upwards (arrow facing up) or downwards (arrow facing down).

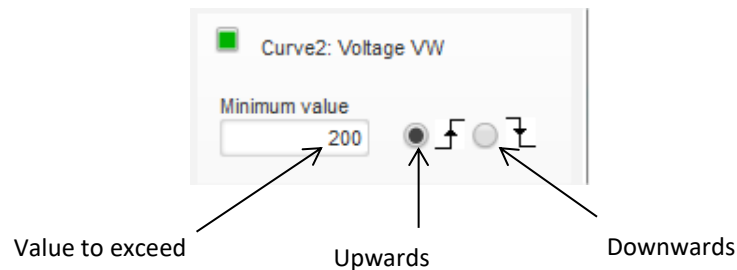

- **Select among the curves, the one which will cause the trip**

- Click on the tick box.
 - If the box was already selected, a confirmation message appears. On clicking “Yes”, a window opens with the list of parameters.

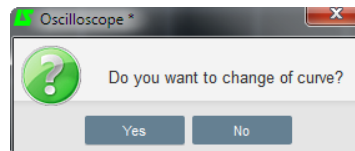

- If the box was not already selected, the window with the list of parameters opens directly.
- Select the parameter you wish to track from the drop-down list. This parameter can be an analog or digital value (regulation mode for example).
- Click “OK” to use the selected parameter, or “Cancel” if you don't wish to change anything.

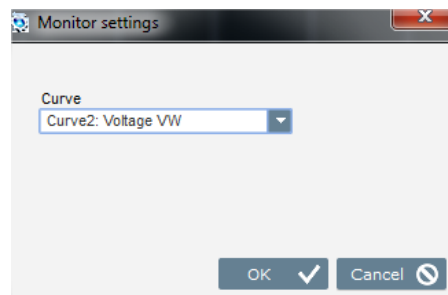

- **Enter the threshold value** to be exceeded
- **Choose the overshoot direction** (up or down)
- **To launch the trigger, click “GO”**
- **To cancel the trigger, deselect the curve**

D350

Digital Voltage Regulator

3.1.8.3. Cursors

Two cursors are available for browsing the curves. The difference between the two values of X (time in seconds) and Y (curve value) is displayed in the “Delta” part.

Cursor	
Cursor 1	
X	22,39
Y	406,30
Cursor 2	
X	45,08
Y	391,60
Delta	
dx	22,69
dy	14,70

The 2 cursors can be moved from one curve to the other by clicking on the cursor dot and dragging it to the desired curve. In the example below, cursor 1 is on the bottom curve and cursor 2 is on the top curve.



D350

Digital Voltage Regulator

3.1.8.4. Transient test

The transient test is used to check the PID response when changing the voltage reference.

It is divided into 5 steps maximum, each of which can take a different reference value. The PID parameters can be changed directly when the command is sent.

- Click on the “Start a transient test” button. The following window opens:

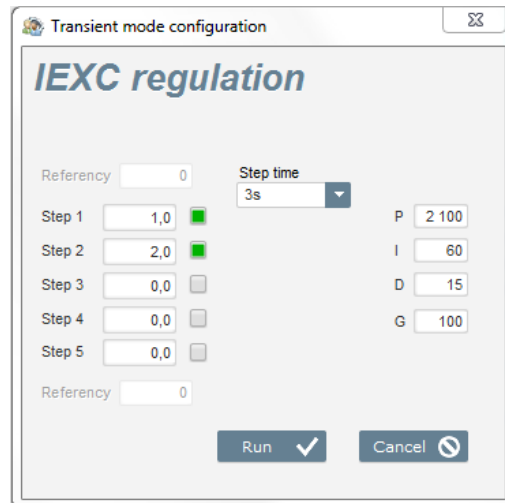

- To configure your transient test:
 - Select between 1 and 5 steps by clicking on the corresponding tick box
 - For each selected step, define the reference value
 - Define the time between each step
- The PID values can be changed in order to adjust the gains.

Once the parameters have been set, click “OK”.

The test then starts. Steps in progress are shown by the reference turning green.

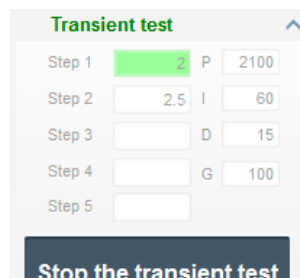

NOTE:

- This test can be stopped at any time by clicking on the “Stop the transient test” button. The display then reverts to the original reference.
- Transient tests cannot be performed if the control reference input is controlled by an analog input, as this has priority.
- During this transient test, the defined minimum and maximum upper and lower limits are not exceeded.

D350

Digital Voltage Regulator

3.1.8.5. Open a curve or an oscilloscope display configuration

The “Open” button (yellow folder) at the bottom right of the oscilloscope window can be used to open an oscilloscope display configuration file (curves, minimum and maximum values, etc.).

By clicking on this folder's right-hand arrow, you can choose to also open a file saved in “.csv” format. Caution, only files generated by the software can be opened.

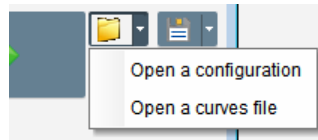

When a curve in “.csv” format is opened, the curve configuration in progress is replaced by the saved curve configuration.

There are two ways to zoom in:

- Click in the oscilloscope plotting area
- Use the mouse wheel: both the X and Y axes are then modified
- Press the “X” button on your keypad and scroll the mouse wheel: only the X axis is modified, the scales on the Y axis remain the same
- Press the “Y” button on your keypad and scroll the mouse wheel: only the Y axis is modified, the scales on the X axis remain the same

3.1.8.6. Save a curve or an oscilloscope display configuration

The “Save” button (disk icon) at the bottom right of the oscilloscope window can be used to save an oscilloscope display configuration file (curves, minimum and maximum values, etc.).

By clicking on this folder's right-hand arrow, you can choose to also save the oscilloscope curves as a “.csv” file.

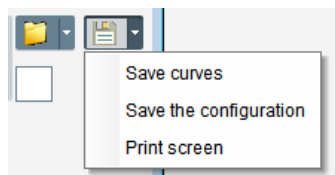

3.1.8.7. Change the plotting area background

The oscilloscope background color can be changed to black by clicking on the white square.



D350

Digital Voltage Regulator

3.1.9. “Monitor” window

This window is used to configure the parameter display in different forms (gauges, graphs, display units).

It is fully configurable and the various objects can be added, moved, modified and/or deleted.

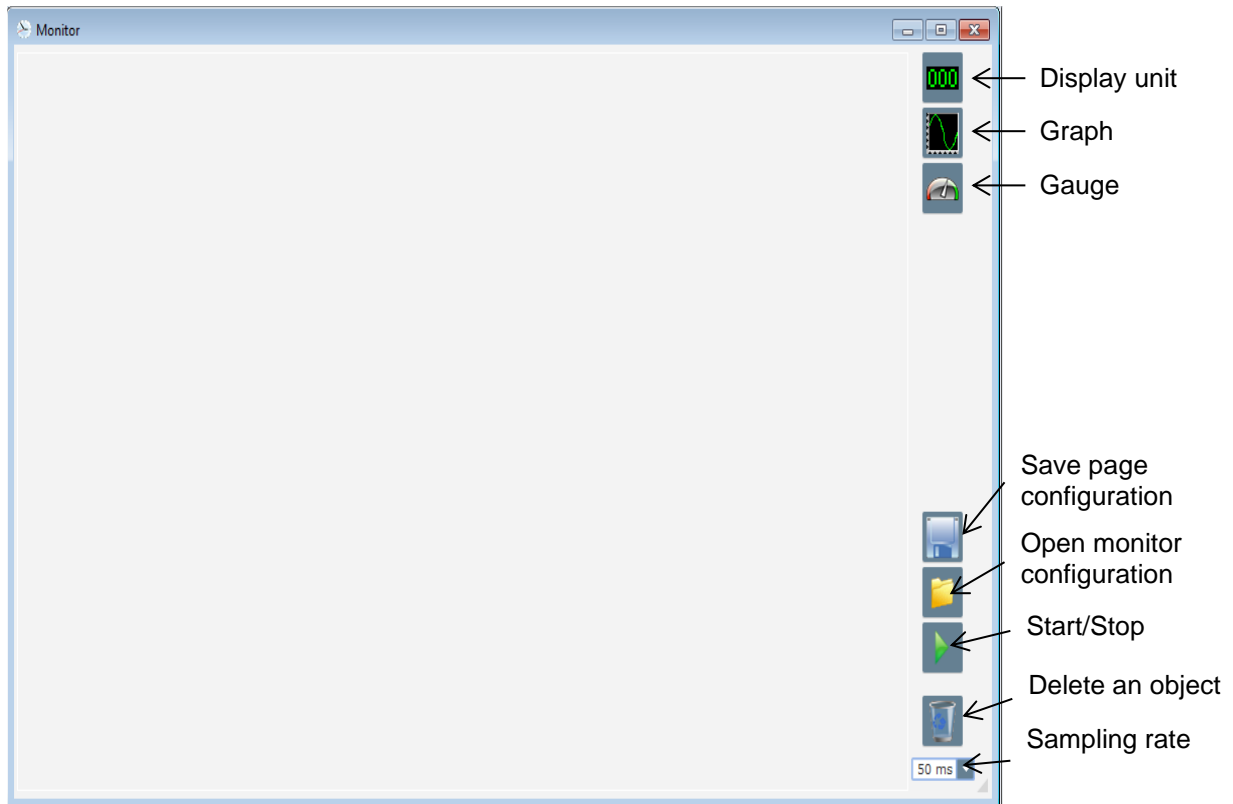

3.1.9.1. Display units

To add a new display unit:

- Click on the “Display” button, a window opens.
- Select the parameter you wish to track from the drop-down list. This parameter can be an analog or digital value (regulation mode for example).

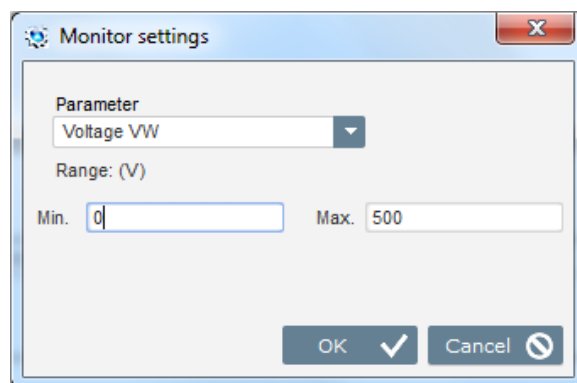

- Click “OK” to use the selected parameter, or “Cancel” if you don't wish to change anything.

D350

Digital Voltage Regulator

- The display unit is then inserted in the monitor in the first free slot (from left to right and then from top to bottom).

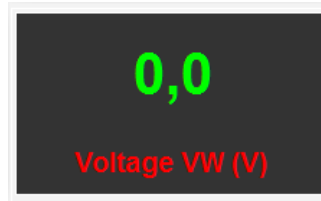

3.1.9.2. Graph

To add a new graph:

- Click on the “Graph” button, a window opens.
- Select the parameter you wish to track from the drop-down list. This parameter can be an analog or digital value (regulation mode for example).

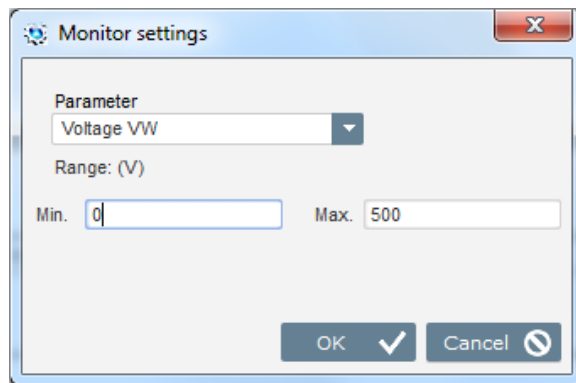

- Click “OK” to use the selected parameter, or “Cancel” if you don't wish to change anything.
- The graph is then inserted in the monitor in the first free slot (from left to right and then from top to bottom).

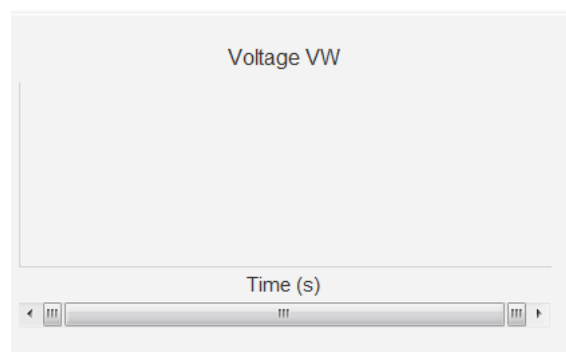

3.1.9.3. Gauges

To add a new gauge:

- Click on the “Gauge” button, a window opens.
- Select the parameter you wish to track from the drop-down list. This parameter can be an analog or digital value (regulation mode for example).

D350

Digital Voltage Regulator

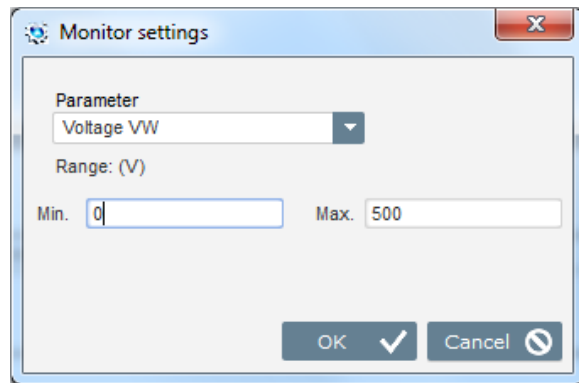

- Click “OK” to use the selected parameter, or “Cancel” if you don’t wish to change anything.
- The gauge is then inserted in the monitor in the first free slot (from left to right and then from top to bottom).

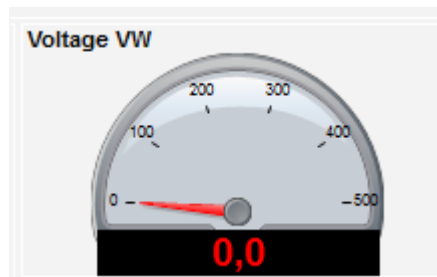

3.1.9.4. Change the size of an object

It is possible to change the size of graphs, gauges and displays.

- Switch to Edit mode by right-clicking in the monitor area
- Click on “Edit mode”

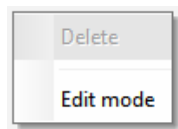

- Go to the middle of one side or corner of the diagram: the cursor becomes a double arrow.

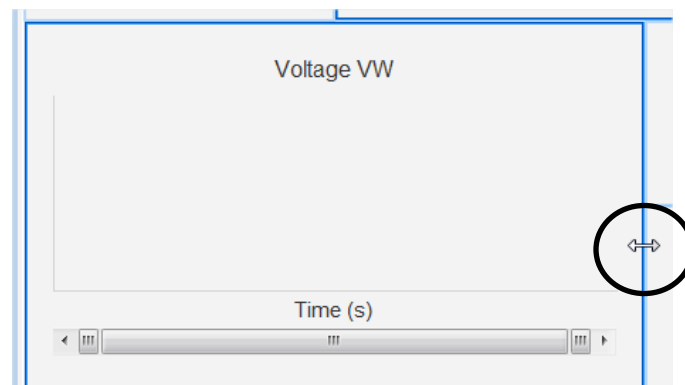

- Click, hold and drag until it is the desired size.

D350

Digital Voltage Regulator

Exit “Edit mode” either by pressing the “Esc” key or by right-clicking in the monitor area and deselecting “Edit mode”.

3.1.9.5. Delete an object

To delete an object (display unit, graph, gauge, etc.):

- Switch to Edit mode by right-clicking in the monitor area
- Click on “Edit mode”

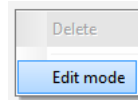

- A grid then appears indicating the position of the various objects
- Right-click on the display unit you wish to delete
- Click “Delete”

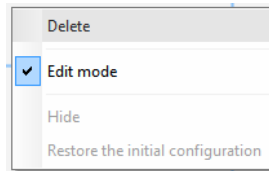

Exit “Edit mode” either by pressing the “Esc” key or by right-clicking in the monitor area and deselecting “Edit mode”.

3.1.9.6. Save a monitor configuration

A monitor configuration can be saved in order to be reused later. Click on the “Save” button and a window will open. Give the name of the desired monitor configuration, and select “Save”.



3.1.9.7. Open a monitor configuration

Click on the “Open” button to retrieve a monitor configuration and a window will open. Select the desired monitor configuration, and select “Open”.



D350

Digital Voltage Regulator

3.2. Operations as analogue AVR

The D350 can be used as a simple analogue AVR. Hereafter are the available features that can be used or adjusted without any computer.

3.2.1. Voltage setting

For recall, 2 potentiometers are available on the D350.

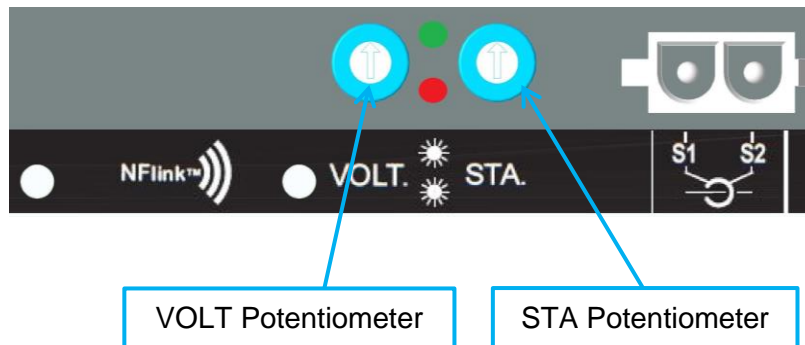

VOLT Potentiometer is dedicated to voltage adjustment. Default factory setting allows to set the voltage from 300V to 530V as shown below.

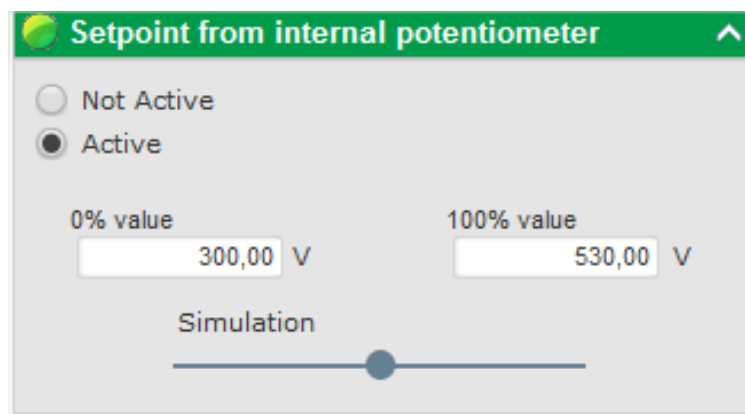

If lower voltage setpoint is needed (for example 230V), then a jumper must be used between **AI1** and **0V** terminals as below.

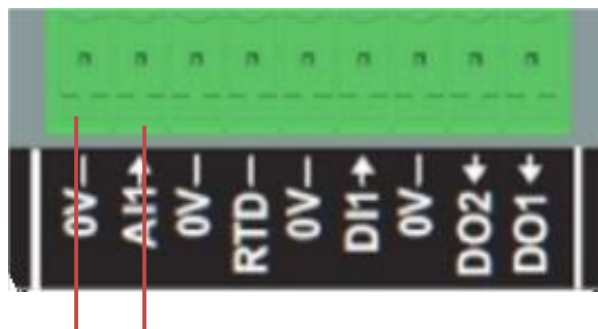

D350

Digital Voltage Regulator

3.2.2. Stability setting

STA Potentiometer is dedicated to the stability setting. With factory settings, counter-clockwise corresponds to low dynamics performance and full-clockwise will lead to high dynamics performances. In general, potentiometer in middle position suits most of the cases.

3.2.3. Drop compensation

For parallel operation between generators, the default setting for droop compensation is 3%.

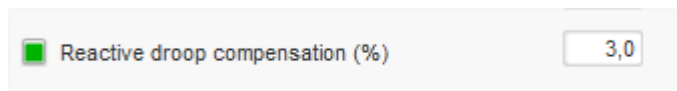

The default configuration is done with 1A secondary CT connected on the AVR terminals S1-S2.

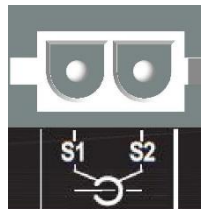

NOTE: If there is a need to use for example a 5A secondary CT, then the D350 must be configured accordingly by using the NFLink cable.

3.2.4. Switching 50/60Hz

This functionality allows to easily go from 50Hz to 60Hz. In the D350, this can be done via the digital input named **DI1** as shown below.

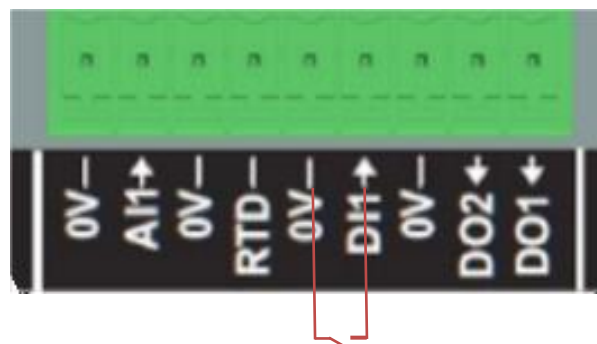

By default, this switching will only affect the AVR knee point and it is the user's responsibility to manually adjust the voltage setpoint to meet his requirements.

NOTE: When the D350 is ordered with Leroy-Somer™ alternators, it is possible to preconfigure this switching function to fit the customer needs. In that case, many customizations can be applied such as connection type, voltage setpoint, soft start, the analog input type, etc.

D350

Digital Voltage Regulator

3.3. Tips and tricks

- Configuration download and upload

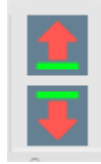

The up and down arrows placed on Easyreg Advanced top bar menu allow to upload configuration into the D350 and to download from the D350, but keyboard shortcuts below can also be used:

- Upload configuration into the D350: **F10**
- Download the configuration from the D350: **CTRL+F10**

- Part parameters upload into the regulator

When changes are made in the delimited area, the part parameters upload button can be used to upload parameters into the regulator; the other parameters remain unchanged.

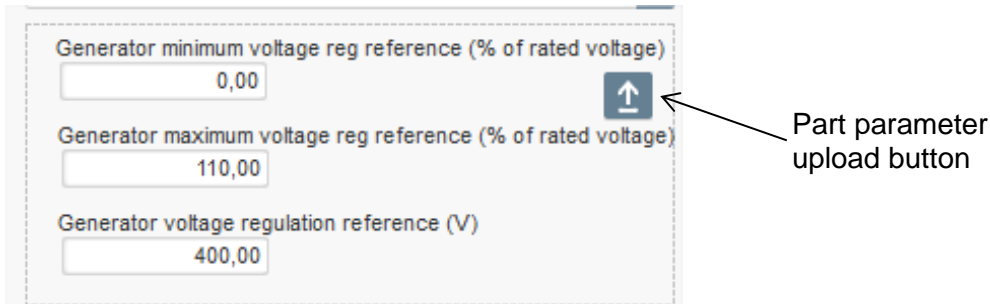

3.4. Comparison window

This window is available by clicking on the button in the home page banner:



The "Comparison" is used to:

- Compare the D350 configuration with a file
 - Click on the file 1 "... " button to select the configuration file.



- Click on the "Run the comparison between the AVR and the file" button.
- The modified parameters appear in the list below.

D350

Digital Voltage Regulator

Parameter Number	Parameter name	Open file value	AVR Value	Unit
002.012	Self-adaptive LAM Engine Help	No	Yes	
002.013	Motor Start	No	Yes	
003.001	Voltage regulation proportional gain	9000	35	
003.002	Voltage regulation integral gain	100	35	
003.003	Voltage regulation derivative gain	1000	35	
003.004	Voltage regulation overall gain	150	35	
003.005	Current regulation proportional gain	2000	35	
003.006	Current regulation integral gain	50	35	
003.007	Current regulation derivative gain	30	35	
003.008	Current regulation overall gain	100	35	
004.001	Generator voltage regulation reference	400	0	V
004.002	Generator maximum voltage reg reference as a % of rated voltage	110	0	%
004.004	Generator field current regulation reference	1	0	A
004.005	Generator maximum excitation current reg reference as a % of rated IEX	100	0	%
004.009	Initial PWM	2	0	%
004.010	Voltage Threshold Start	100	0	Vac
004.011	Threshold Start PWM	2	0	%
004.012	Soft start time	10	0	s

- **Compare two configuration files**
 - Click on the file 1 “...” button to select the first configuration file
 - Click on the file 2 “...” button to select the second configuration file
 - Click on the “Compare” button on the right

File 1 ...

File 2 ...

- The modified parameters appear in the list below:

Parameter Number	Parameter name	File 1 value	File 2 value	Unit
011.004	Generator Current Range	1A	5A	
002.005	Line Drop Compensation Enable	Yes	No	
003.001	Voltage regulation proportional gain	1	9000	
003.002	Voltage regulation integral gain	1	100	
003.003	Voltage regulation derivative gain	0	1500	
003.004	Voltage regulation overall gain	100	150	
003.005	Current regulation proportional gain	1	2000	
003.006	Current regulation integral gain	1	50	
003.007	Current regulation derivative gain	0	15	
004.001	Generator voltage regulation reference	440	400	V
004.008	Line drop compensation as a % of rated voltage	3	0	%
004.012	Soft start time	0	10	s

D350

Digital Voltage Regulator

4. APPENDICES

4.1. Vector permutations

When the stator current measurement CT is wired up, the vector permutations can compensate for voltage measurement and current measurement transformer layouts which generate malfunction of the reactive droop compensation.

The table below gives the possible permutations according to the phase used for the stator current measurement CT.

Position of stator current measurement CT	Alternator direction of rotation (a/c IEC 60034-1)	Alternator voltage measurement			
		AVR terminals	U	V	W
Phase U (standard)	Clockwise	Alternator phases (three-phase measurement)	U	V	W
		Alternator phases (phase/phase single-phase measurement)	-	V	W
	Anti-clockwise	Alternator phases (three-phase measurement)	W	V	U
		Alternator phases (phase/phase single-phase measurement)	-	W	V
Phase V	Clockwise	Alternator phases (three-phase measurement)	V	W	U
		Alternator phases (phase/phase single-phase measurement)	-	W	U
	Anti-clockwise	Alternator phases (three-phase measurement)	U	W	V
		Alternator phases (phase/phase single-phase measurement)	-	U	W
Phase W	Clockwise	Alternator phases (three-phase measurement)	W	U	V
		Alternator phases (phase/phase single-phase measurement)	-	U	V
	Anti-clockwise	Alternator phases (three-phase measurement)	V	U	W
		Alternator phases (phase/phase single-phase measurement)	-	V	U

D350

Digital Voltage Regulator

4.2. Regulation modes prioritization

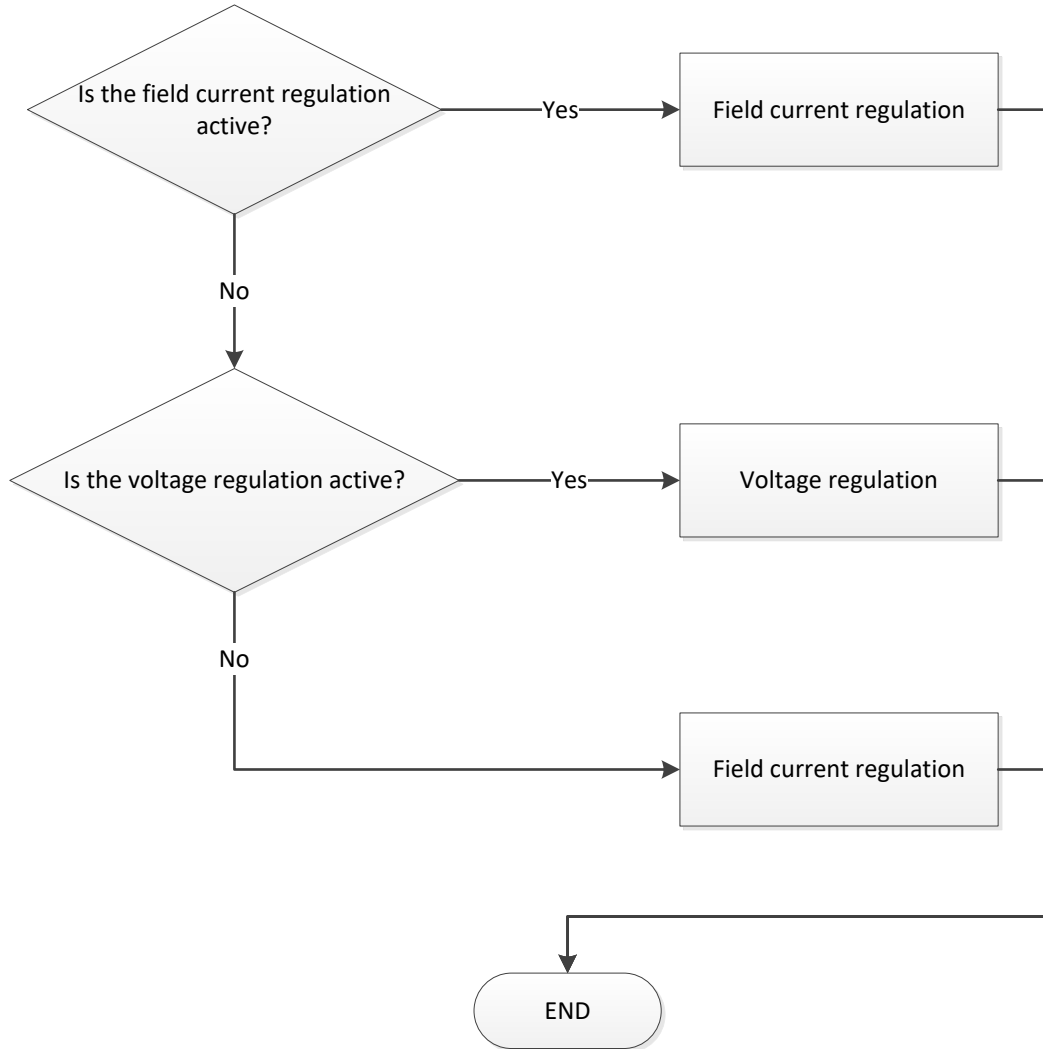

D350

Digital Voltage Regulator

4.3. Electrical diagrams

4.3.1. SHUNT

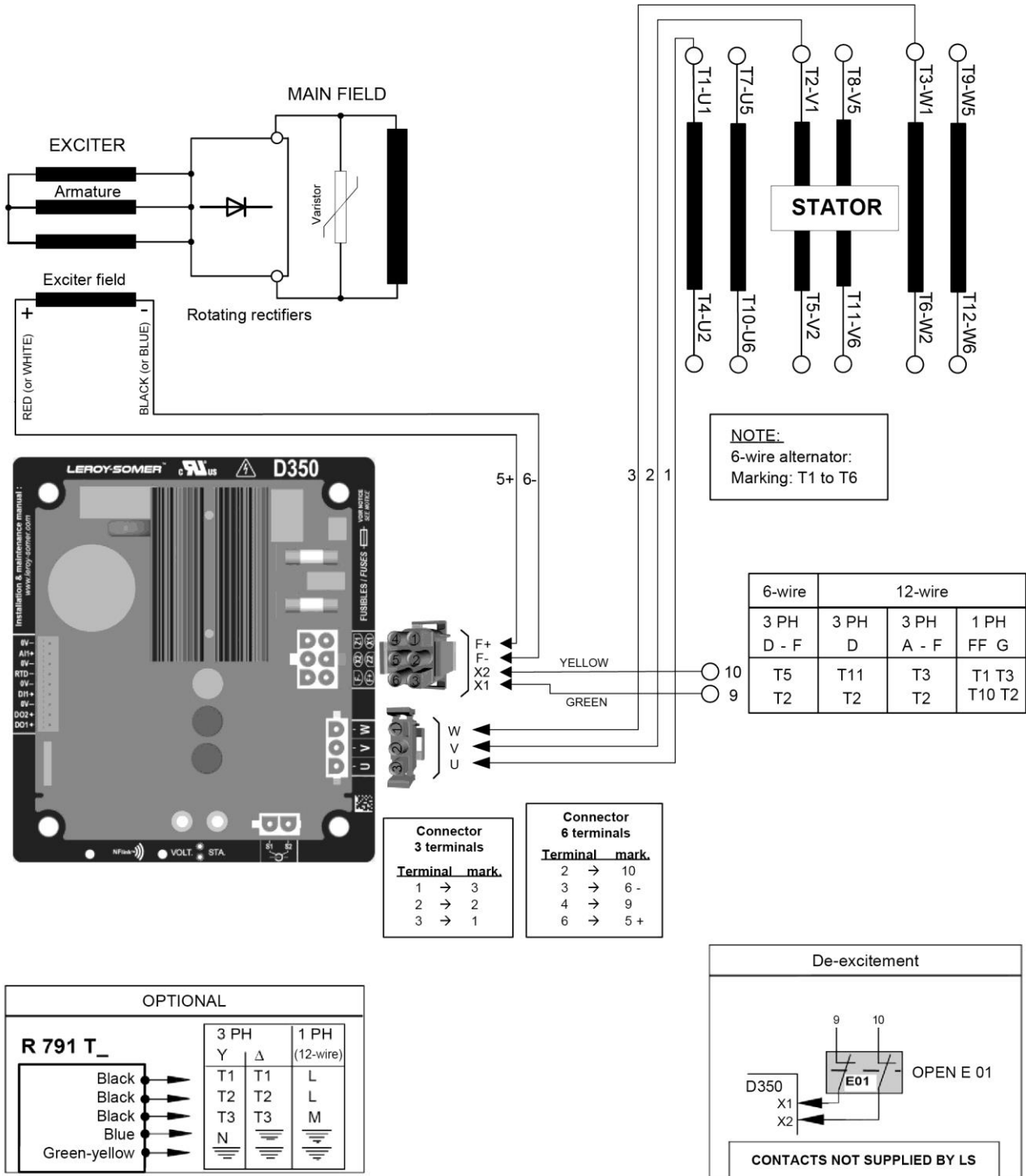

D350

Digital Voltage Regulator

4.3.2. AREP

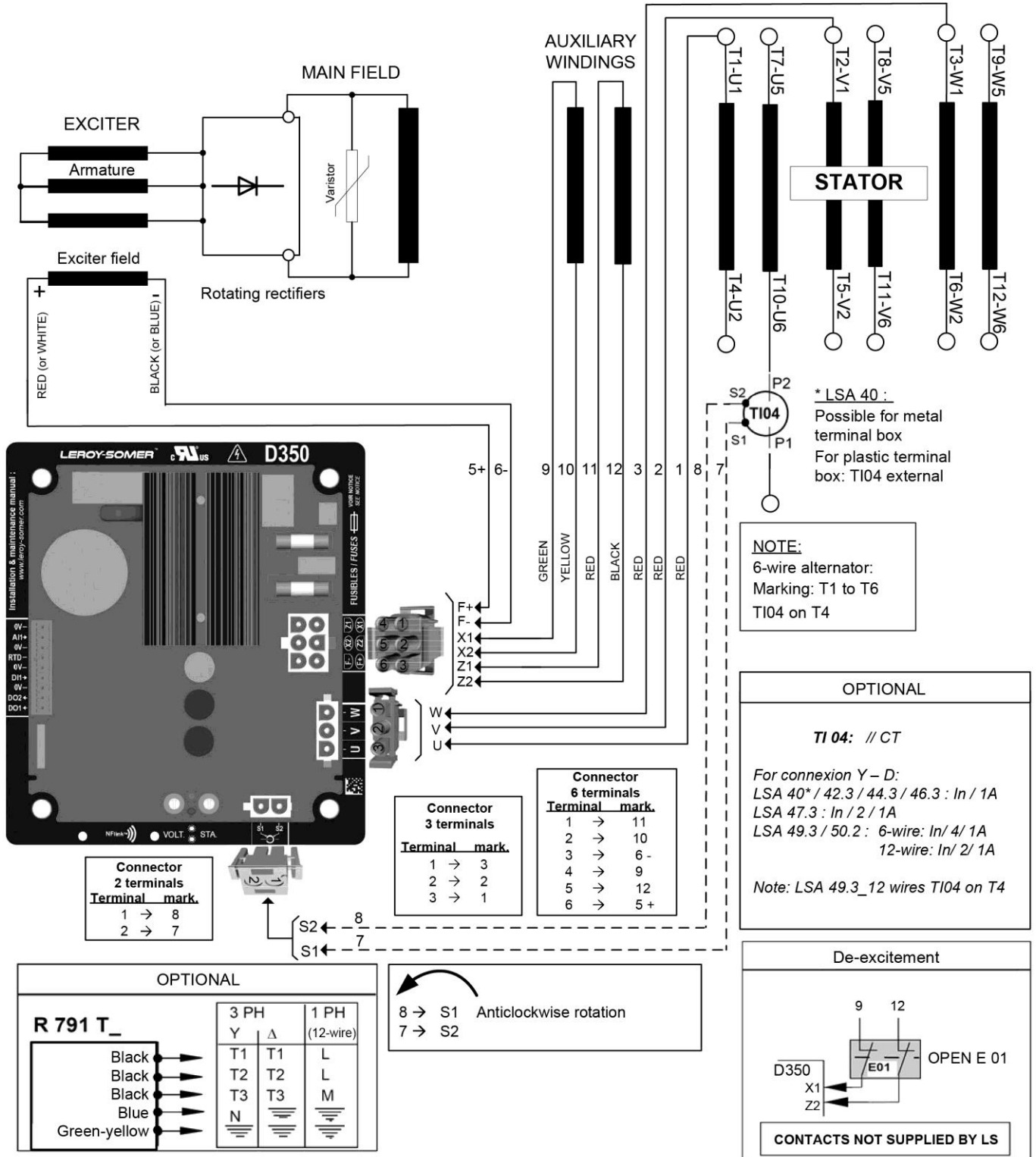

D350

Digital Voltage Regulator

4.3.3. PMG

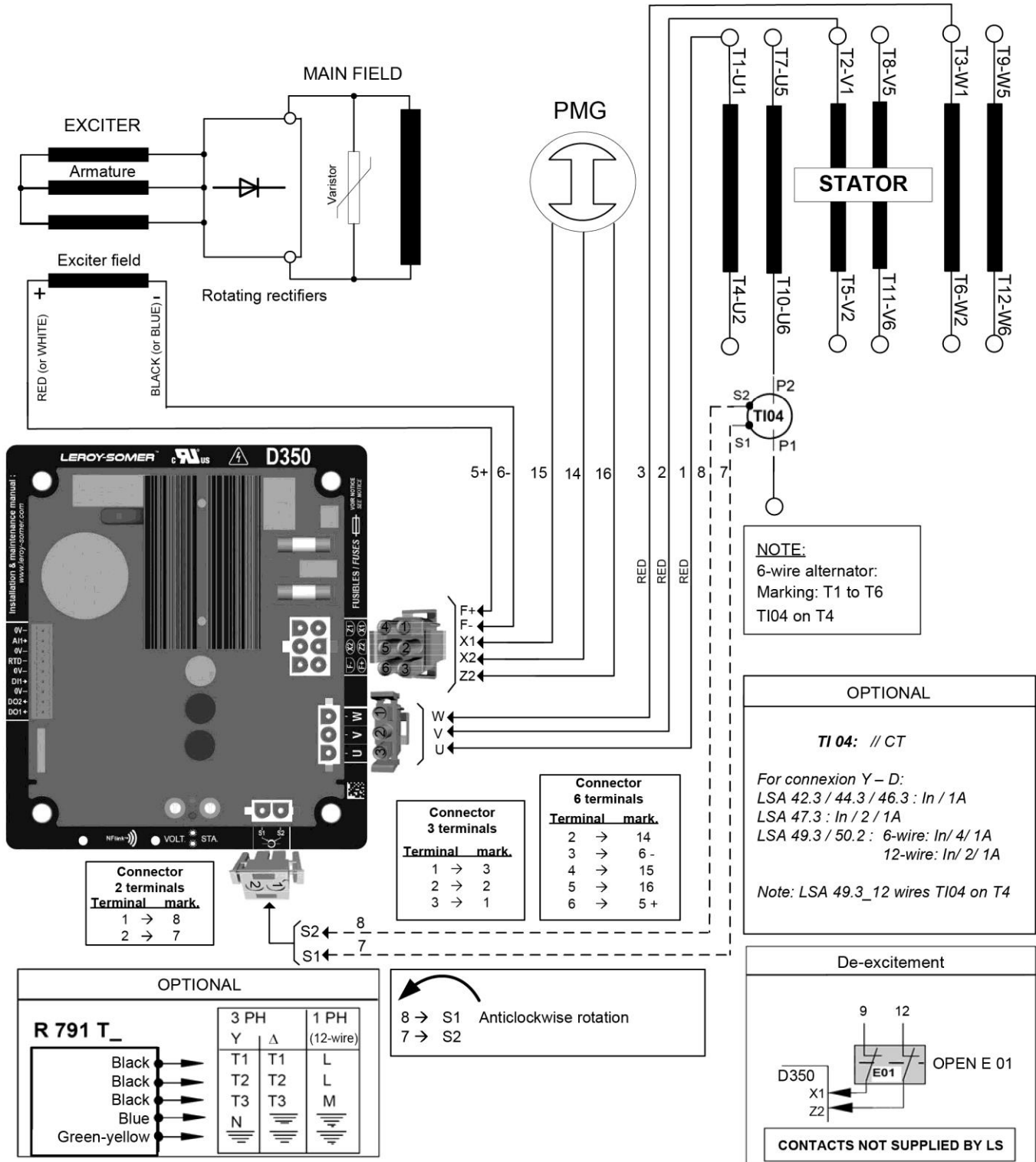

D350

Digital Voltage Regulator

4.4. Faults trouble shouting

4.4.1. No Voltage

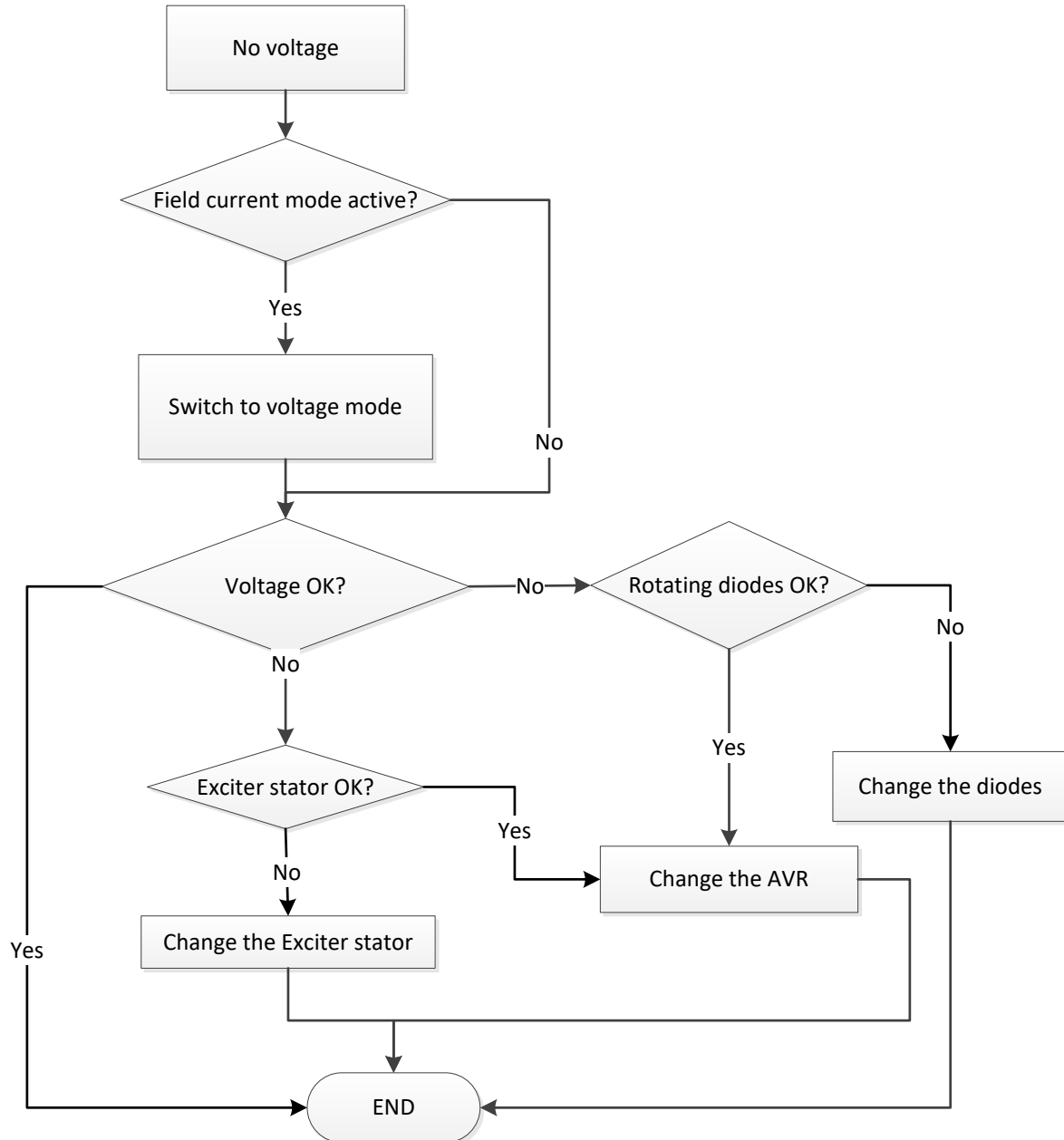

D350

Digital Voltage Regulator

4.4.2. Voltage too low

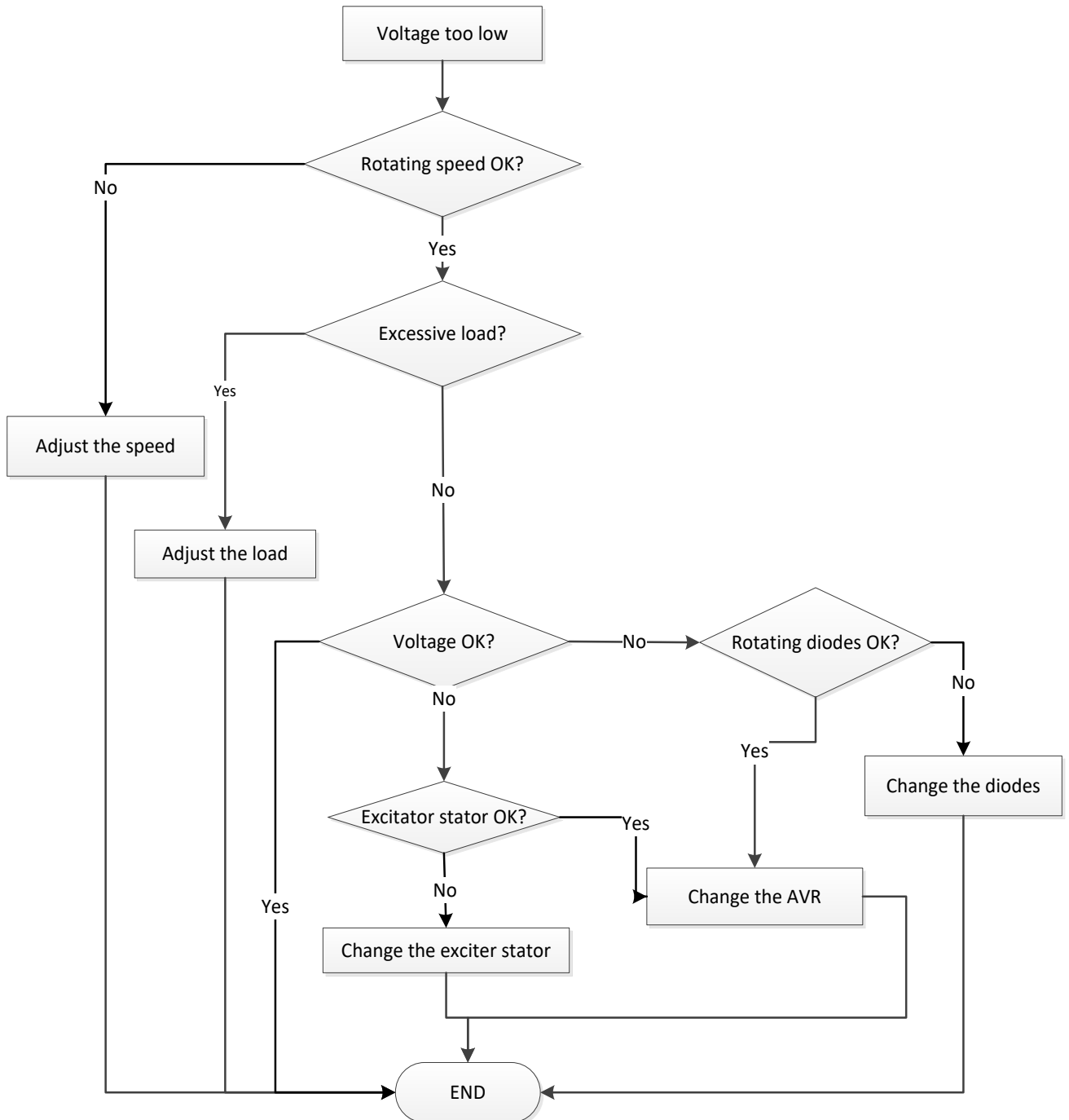

D350

Digital Voltage Regulator

4.4.3. Voltage unstable

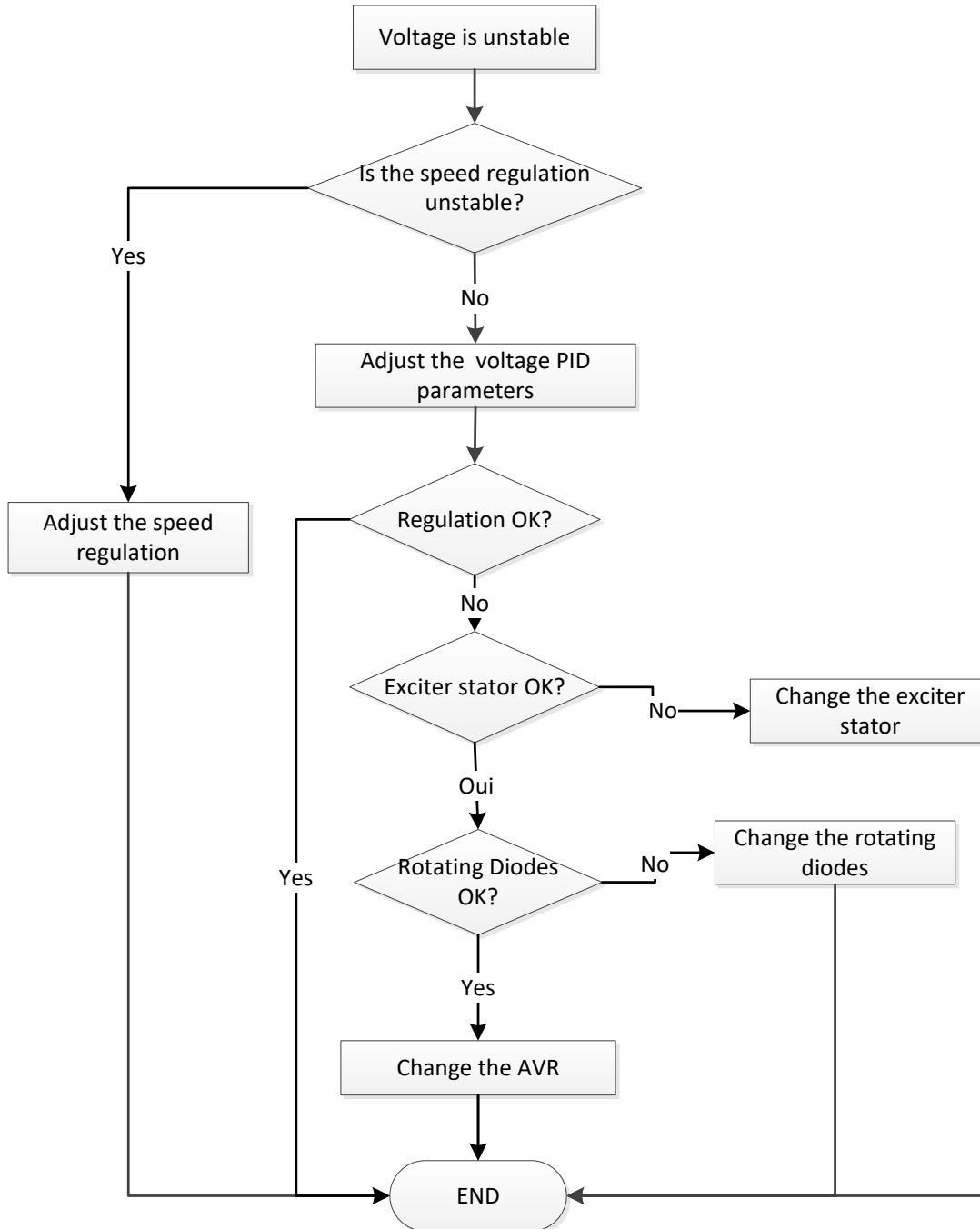

D350

Digital Voltage Regulator

4.4.4. Important voltage drop on load

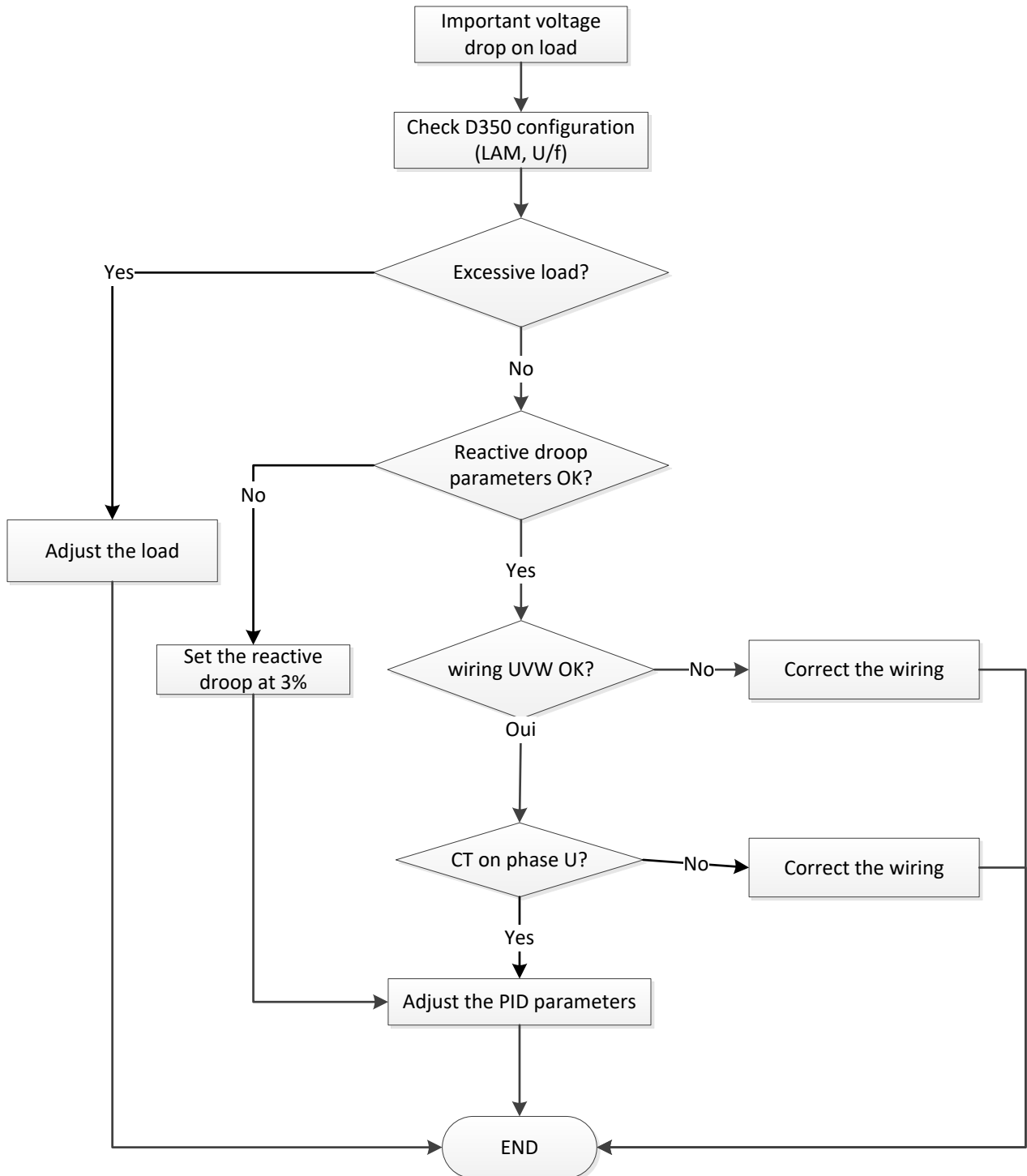

D350

Digital Voltage Regulator

4.4.5. Time response too long

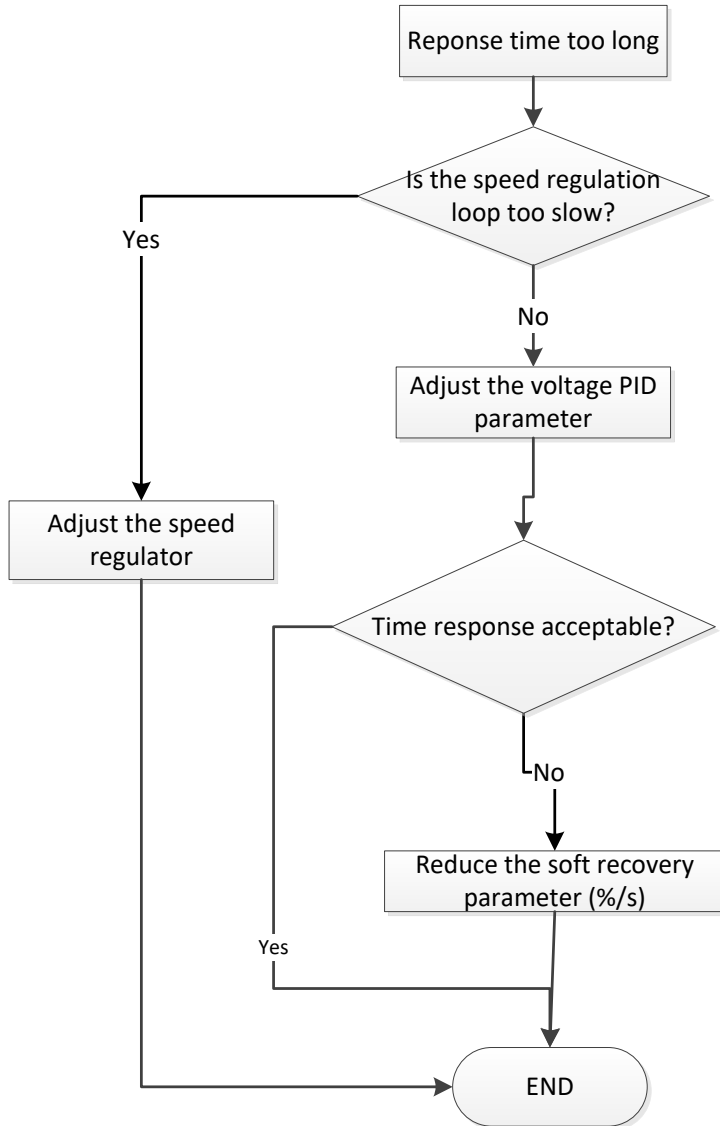

D350

Digital Voltage Regulator

D350

Digital Voltage Regulator

Service & Support

Our worldwide service network of over 80 facilities is at your service. Our local presence is your guarantee for fast and efficient repair, support and maintenance services.

Trust your alternator maintenance and support to electric power generation experts. Our field personnel are 100% qualified and fully trained to operate in all environments and on all machine types.

We have a deep understanding of alternators operations, providing the best value service to optimize your cost of ownership.

How can we help:

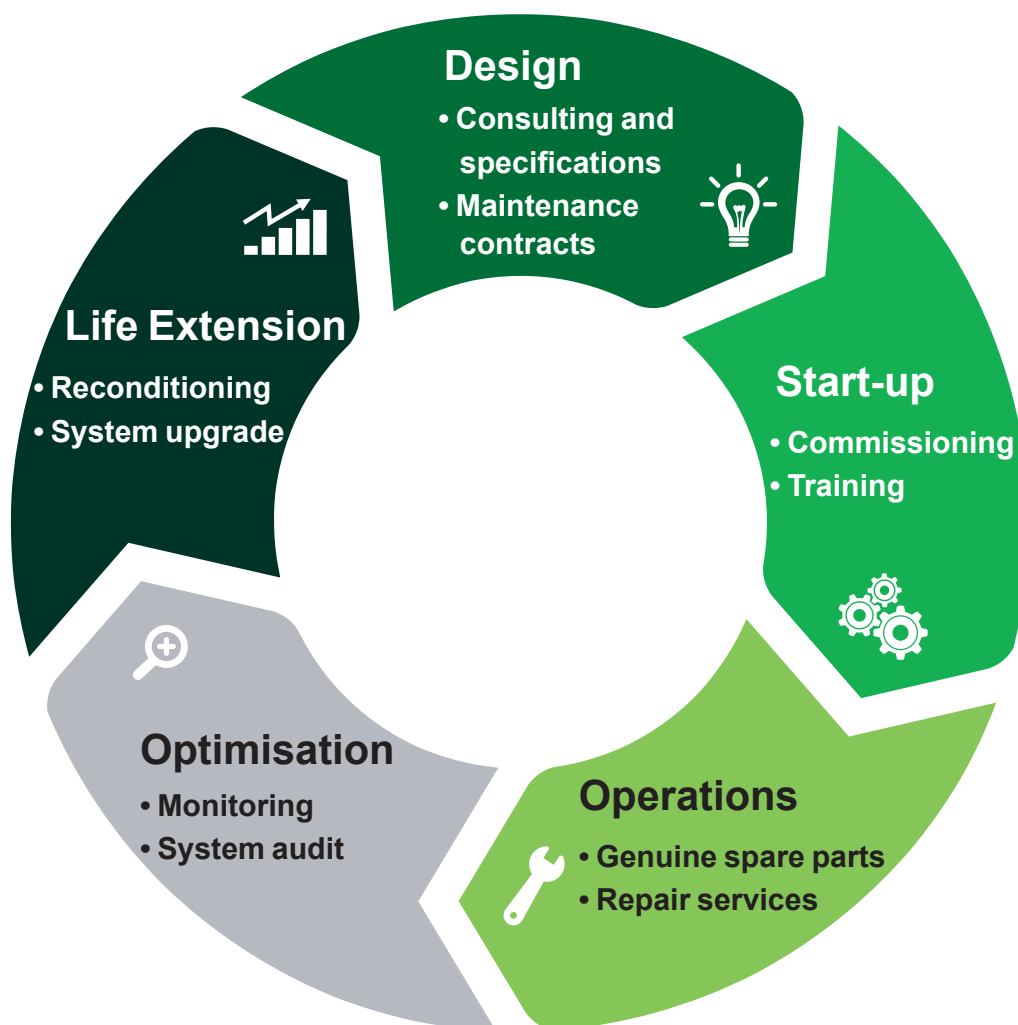

Contact us:

Americas: +1 (507) 625 4011

EMEA: +33 238 609 908

Asia Pacific: +65 6250 8488

China: +86 591 8837 3010

India: +91 806 726 4867



Scan the code or go to:
www.lrsm.co/support

 service.epg@leroy-somer.com

Nidec
All for dreams

www.nidecpower.com

Connect with us at:

