

Nidec

Power



TAL 042

Low Voltage Alternator - 4 poles

18 to 63 kVA - 50 Hz / 23 to 79 kVA - 60 Hz

Electrical and mechanical data

LEROY-SOMER[™]

The best of performance

The Leroy-Somer™ TAL 042 alternator has been designed to offer you the best power generation performances. With its meticulous design and optimized architecture, the TAL 042 strikes the perfect balance between compactness, reliability, performance and longevity. Whatever your application, the Leroy-Somer™ TAL 042 alternator will meet your needs and will adapt to all situations.

Standards

The Leroy-Somer™ TAL 042 alternator meets all key international standards and regulations, including IEC 60034, NEMA MG 1.32-33, ISO 8528-3, CSA C22.2 n°100-14 and UL 1446 (UL 1004 on request). Also compliant with IEC 61000-6-2, IEC 61000-6-3, IEC 61000-6-4, VDE 0875G, VDE 0875N and EN 55011, group 1 class A for European zone. The Leroy-Somer™ TAL 042 alternator can be integrated in EC marked generator set, and bears EC, UKCA and CMIM markings. It is designed, manufactured and marketed in an ISO 9001 and ISO 14001 quality assurance environment.

Electrical characteristics and performances

- Class H insulation
- Shunt excitation
- Low voltage winding:
 - Three-phase 50 Hz: 220V - 240V and 380V - 415V (440V)
 - 60 Hz: 208V - 240V and 380V - 480V
 - Single-phase 50 Hz: 115V - 230V
 - 60 Hz: 120V - 240V
- 4-terminal plates in 6-wire version
- Optimized performance

Excitation and regulation system

	Excitation system				Regulation options	
	AVR	SHUNT	AREP+ (option)	PMG (option)	ULc/us	Remote voltage potentiometer
Three-phase 6-wire	R120	Standard				
	R150	Option				√
	R180		Standard	Standard		√
	D350	Option	Option	Option	√	√
Three-phase 12-wire	R120	Standard				
	R220	Option			√	√
	R180		Standard	Standard		√
	D350	Option	Option	Option	√	√
Single-phase	R121	Standard				√
	R221	Option			√	√

Protection system and options

- Degree of protection: IP 23
- Complete winding protection for non-harsh environment with relative humidity ≤ 95%
- Options:
 - Three-phase 12-wire with 8-terminal plates
 - AREP+ or PMG excitation
 - ULc/us
 - Customized painting (unpainted machine as standard)
 - Space heater
 - Flying leads
 - Dedicated single-phase
 - Winding 8 optimized for three-phase 380V / 416V - 60Hz
 - Reinforced winding protection for harsh environments and relative humidity greater than 95% (system 2 - 4): derating according to the following table

Type	50 Hz			60 Hz
	380V	400V	415V	All voltages
TAL 042	0.97	1 except 0.97 for TAL 042 G	1 except 0.97 for TAL 042 G	1 except 0.97 for TAL 042 G

Mechanical construction

- Compact and rugged assembly to withstand engine vibrations
- Steel frame
- Aluminum flanges and shields
- Single-bearing design compatible with most diesel engines
- Greased for life bearings
- Direction of rotation: clockwise and counterclockwise without derating

Terminal box design

- Easy access to AVR and terminals



TAL 042 - Three-phase 25 to 63 kVA - 50 Hz / 31.5 to 79 kVA - 60 Hz

General characteristics

Insulation class	H	Excitation system 6-wire	SHUNT	AREP+ / PMG
Winding pitch	2/3 (wind.6S - 6-wire / wind.6 - 12-wire)	AVR type	R120	R180
Number of wires	6 (12 option)	Excitation system 12-wire (option)	SHUNT	AREP+ / PMG
Protection	IP 23	AVR type	R120	R180
Altitude	≤ 1000 m	Voltage regulation (**)	± 1 %	± 0.5 %
Overspeed	2250 R.P.M.	Total Harmonic Distortion THD (***) in no-load		< 2 %
Air flow 50 Hz	0.10 m³/s	Total Harmonic Distortion THD (***) in linear load		< 5 %
Air flow 60 Hz	0.13 m³/s	Waveform: NEMA = TIF (***)		< 50
AREP+/PMG Short-circuit current = 2.7 In: 5 seconds (*)		Waveform: I.E.C. = FHT (***)		< 2%

(*) D350: 10 seconds (**) Steady state (***) Total harmonic distortion between phases, no-load or on-load (non-distorting)

Ratings 50 Hz - 1500 R.P.M.

kVA / kW - P.F. = 0.8																					
Duty / T° C		Continuous / 40 °C				Continuous / 40 °C				Stand-by / 40 °C				Stand-by / 27 °C							
Class / T° K		H / 125° K				F / 105° K				H / 150° K				H / 163° K							
Phase		3 ph.		1 ph.		3 ph.		1 ph.		3 ph.		1 ph.		3 ph.		1 ph.					
Y		380V	400V	415V	440V	380V	400V	415V	440V	380V	400V	415V	440V	380V	400V	415V	440V				
Δ		220V	230V	240V	230V	220V	230V	240V	230V	220V	230V	240V	230V	220V	230V	240V	230V				
YY (*)		200V		220V		200V		220V		200V		220V		200V		220V					
ΔΔ (*)																					
		230V				230V				230V				230V							
TAL 042 A	kVA	25	25	25	24.5	15	23	23	23	22.5	13.5	26.5	26.5	26.5	26	16	27.5	27.5	27.5	27	16.5
	kW	20	20	20	19.5	12	18.5	18.5	18.5	18	11	21	21	21	21	13	22	22	22	21.5	13
TAL 042 B	kVA	27	27	27	26	16	24.5	24.5	24.5	23.5	14.5	28.5	28.5	28.5	27.5	17	30	30	30	28.5	17.5
	kW	21.5	21.5	21.5	21	13	19.5	19.5	19.5	19	11.5	23	23	23	22	13.5	24	24	24	23	14
TAL 042 C	kVA	31	32	32	30	19	28	29	29	27.5	17.5	33	34	34	32	20	34	35	35	33	21
	kW	25	25.5	25.5	24	15	22.5	23	23	22	14	26.5	27	27	25.5	16	27	28	28	26.5	17
TAL 042 D	kVA	35	35	35	30.5	22	32	32	32	28	20	37	37	37	32.5	23.5	38.5	38.5	38.5	33.5	24
	kW	28	28	28	24.5	17.5	25.5	25.5	25.5	22.5	16	29.5	29.5	29.5	26	19	31	31	31	27	19
TAL 042 E	kVA	39.5	40	40	35	25	36	36.5	36.5	32	23	42	42.5	42.5	37	26.5	43.5	45	45	38.5	27.5
	kW	31.5	32	32	28	20	29	29	29	25.5	18.5	33.5	34	34	29.5	21	35	36	36	31	22
TAL 042 F	kVA	43	45	45	39	27	39	41	41	35.5	24.5	45.5	47.5	47.5	41.5	28.5	47.5	50	50	43	29.5
	kW	34.5	36	36	31	21.5	31	33	33	28.5	19.5	36.5	38	38	33	23	38	40	40	34.5	23.5
TAL 042 G	kVA	47.5	50	50	43	30	43	45.5	45.5	39	27.5	50	53	53	45.5	32	52	55	55	47.5	33
	kW	38	40	40	34.5	24	34.5	36.5	36.5	31	22	40	42	42	36.5	25.5	42	44	44	38	26.5
TAL 042 H	kVA	58	60	60	52	36	53	55	55	47	33	61	64	64	55	38	64	66	66	57	39.5
	kW	46	48	48	42	29	42	44	44	37.5	26.5	49	51	51	44	30.5	51	53	53	46	31.5
TAL 042 J	kVA	58	63	63	52	36	53	58	58	47	33	61	67	67	55	38	64	70	70	57	39.5
	kW	46	50	50	42	29	42	46	46	37.5	26.5	49	54	54	44	30.5	51	56	56	46	31.5

(*) 12-wire option

Ratings 60 Hz - 1800 R.P.M.

kVA / kW - P.F. = 0.8																					
Duty / T° C		Continuous / 40 °C				Continuous / 40 °C				Stand-by / 40 °C				Stand-by / 27 °C							
Class / T° K		H / 125° K				F / 105° K				H / 150° K				H / 163° K							
Phase		3 ph.		1 ph.		3 ph.		1 ph.		3 ph.		1 ph.		3 ph.		1 ph.					
Y		380V	416V	440V	480V	380V	416V	440V	480V	380V	416V	440V	480V	380V	416V	440V	480V				
Δ		220V	240V		240V	220V	240V		240V	220V	240V		240V	220V	240V		240V				
YY (*)		208V		240V		208V		240V		208V		240V		208V		240V					
ΔΔ (*)																					
		240V				240V				240V				240V							
TAL 042 A	kVA	29	31.5	31.5	31.5	18.9	26.5	28.5	28.5	28.5	17	30.5	33.5	33.5	33.5	20	32	34.5	34.5	34.5	20.8
	kW	23	25	25	25	15	21	23	23	23	13.5	24.5	27	27	27	16	25.5	27.5	27.5	27.5	16.5
TAL 042 B	kVA	30	32	34	34	19.2	27.5	29	31	31	17.5	32	34	36	36	20.5	33	35	37.5	37.5	21.1
	kW	24	25.5	27	27	15.5	22	23	25	25	14	25.5	27	29	29	16.5	26.5	28	30	30	17
TAL 042 C	kVA	33.5	37	39	40	23	30.5	33.5	35.5	36.5	21	35.5	39	41.5	42.5	24.5	37	40.5	43	44	25.5
	kW	27	29.5	31	32	18.5	24.5	27	28.5	29	17	28.5	31	33	34	19.5	29.5	32.5	34.5	35	20.5
TAL 042 D	kVA	37.5	40.5	43	44	24	34	37	39	40	22	40	43	45.5	46.5	25.5	41.5	44.5	47.5	48.5	26.5
	kW	30	32.5	34.5	35	19	27	29.5	31	32	17.5	32	34.5	36.5	37	20.5	33	35.5	38	39	21
TAL 042 E	kVA	41.5	45.5	48.5	50	27.5	38	41.5	44	45.5	25	44	48	51	53	29	45.5	50	53.5	55	30.5
	kW	33	36.5	39	40	22	30.5	33	35	36.5	20	35	38.5	41	42	23	36.5	40	43	44	24.5
TAL 042 F	kVA	44	48	51	56.5	30	40	43.5	46.5	51	27.5	46.5	51	54	60	32	48.5	53	56	62	33
	kW	35	38.5	41	45	24	32	35	37	41	22	37	41	43	48	25.5	39	42	45	50	26.5
TAL 042 G	kVA	49	53.5	56.5	62.5	34	44.5	48.5	51	57	31	52	57	60	66.5	36	54	59	62	69	37.5
	kW	39	43	45	50	27	35.5	39	41	46	25	42	46	48	53	29	43	47	50	55	30
TAL 042 H	kVA	57	65	66.5	75	39	52	59	61	68	35.5	60	69	70	80	41.5	62.5	72	73	82.5	43
	kW	46	52	53	60	31	42	47	49	54	28.5	48	55	56	64	33	50	58	58	66	34.5
TAL 042 J	kVA	63	68	70	79	39	58	62	64	72	35.5	67	73	75	84	41.5	69	75	77	87	43
	kW	50	54	56	63	31	46	50	51	58	28.5	54	58	60	67	33	55	60	62	70	34.5

(*) 12-wire option

TAL 042 - Three-phase 25 to 63 kVA - 50 Hz / 31.5 to 79 kVA - 60 Hz

Efficiencies 400 V - 50 Hz (— P.F.: 0.8) (--- P.F.: 1)

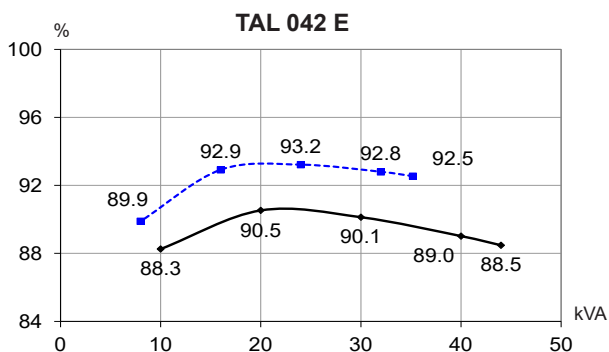
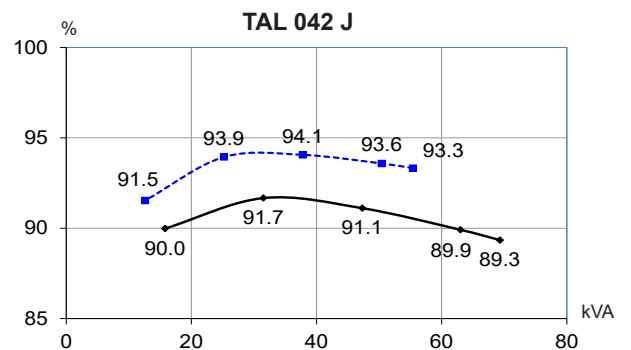
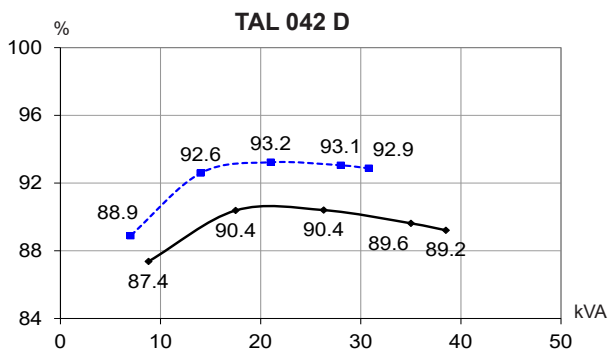
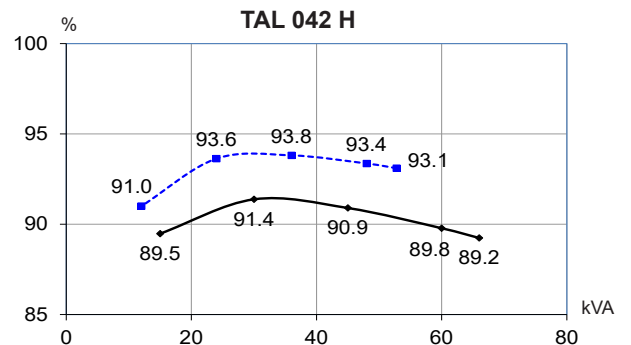
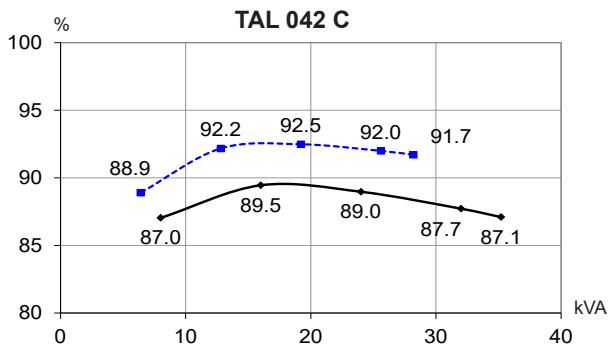
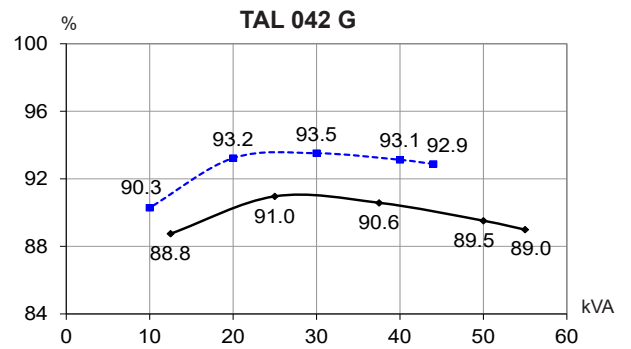
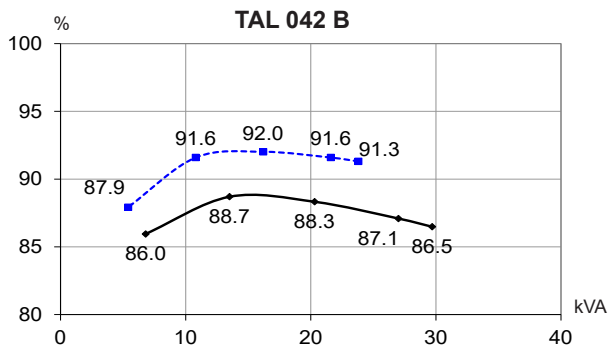
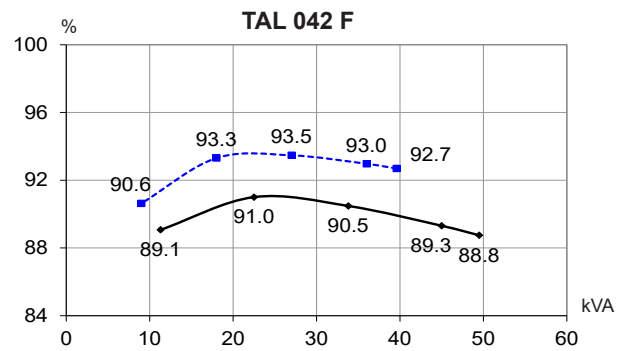
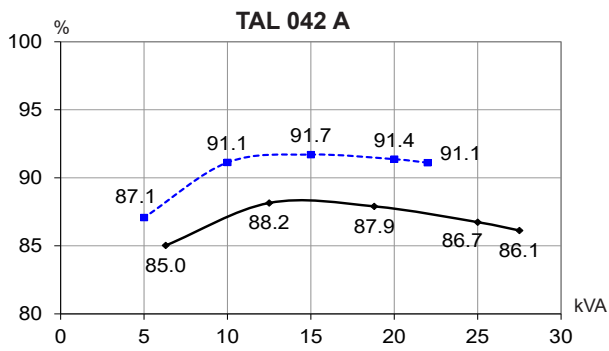

TAL 042 - Three-phase 25 to 63 kVA - 50 Hz / 31.5 to 79 kVA - 60 Hz

Efficiencies 480 V - 60 Hz (— P.F.: 0.8) (--- P.F.: 1)

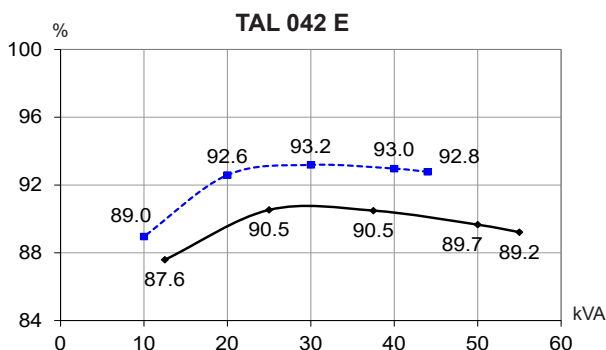
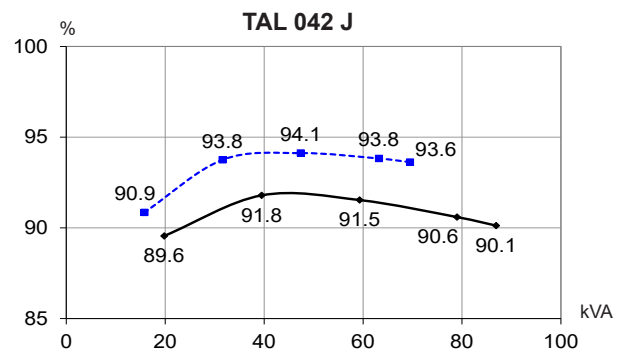
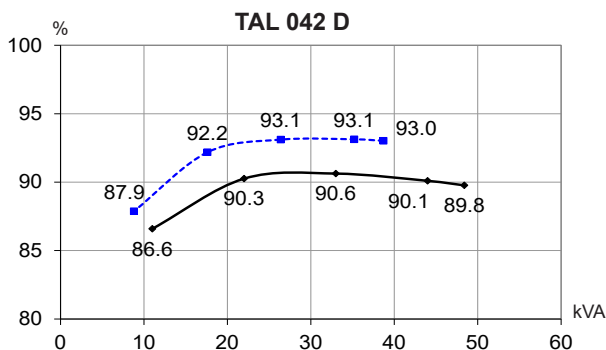
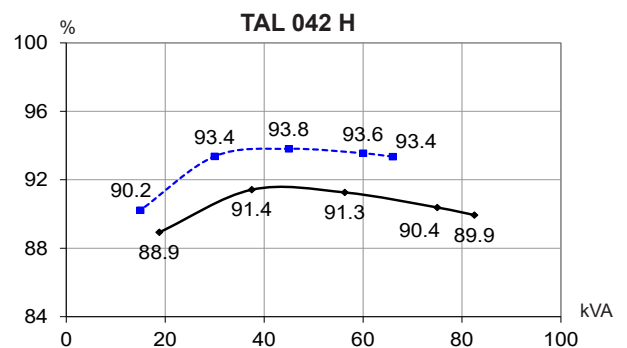
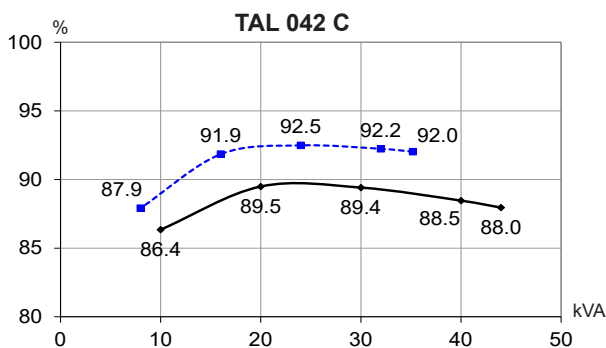
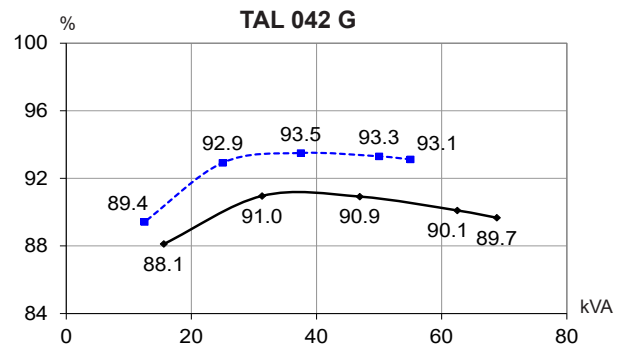
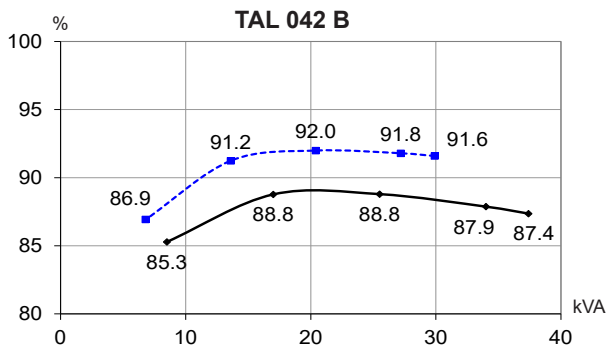
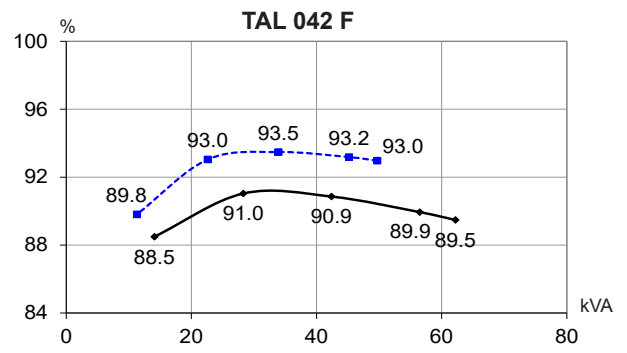
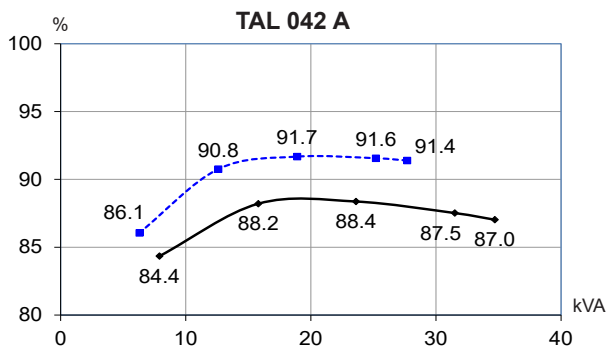

Reactances (%). Time constants (ms) - Class H / 400 V

	A	B	C	D	E	F	G	H	J
Kcc Short-circuit ratio	0.49	0.46	0.44	0.49	0.42	0.4	0.43	0.4	0.42
Xd Direct-axis synchronous reactance unsaturated	257	267	279	246	281	294	283	303	297
Xq Quadrature-axis synchronous reactance unsaturated	131	136	142	125	143	150	144	154	151
T'do No-load transient time constant	786	813	861	944	944	980	998	1031	962
X'd Direct-axis transient reactance saturated	16.3	16.4	16.2	13	14.8	15	14.1	14.7	15.4
T'd Short-circuit transient time constant	50	50	50	50	50	50	50	50	50
X''d Direct-axis subtransient reactance saturated	8.1	8.2	8.1	6.5	7.4	7.5	7	7.3	7.7
T''d Subtransient time constant	5	5	5	5	5	5	5	5	5
X''q Quadrature-axis subtransient reactance saturated	11.5	11.6	11.5	9.2	10.6	10.7	10.1	10.5	11
Xo Zero sequence reactance	0.68	0.68	0.67	0.54	0.62	0.62	0.59	0.61	0.64
X2 Negative sequence reactance saturated	9.88	9.91	9.82	7.89	9.02	9.12	8.61	8.93	9.37
Ta Armature time constant	8	8	8	8	8	8	8	8	8

Other class H / 400 V data

io (A) No-load excitation current SHUNT	0.65	0.62	0.61	0.58	0.58	0.55	0.6	0.53	0.55
io (A) No-load excitation current AREP+	1	0.95	0.93	0.89	0.89	0.85	0.92	0.82	0.85
ic (A) On-load excitation current SHUNT	2.16	2.15	2.22	1.93	2.19	2.22	2.35	2.15	2.25
ic (A) On-load excitation current AREP+	3.31	3.3	3.4	2.96	3.35	3.4	3.6	3.3	3.45
uc (V) On-load excitation voltage SHUNT	37.2	36.9	37.9	32.9	36.9	37.1	38.9	51.2	53.3
uc (V) On-load excitation voltage AREP+	24	23.8	24.4	21.2	23.8	23.9	25.1	32.9	34.3
ms Response time ($\Delta U = 20\%$ transient)	500	500	500	500	500	500	500	500	500
kVA Start ($\Delta U = 20\%$ cont. or $\Delta U = 30\%$ trans.) SHUNT*	37	40	48	66	66	73	86	100	100
kVA Start ($\Delta U = 20\%$ cont. or $\Delta U = 30\%$ trans.) AREP+*	58	63	75	103	103	114	135	143	143
% Transient ΔU (on-load 4/4) SHUNT - P.F.: 0.8 _{LAG}	20.1	20.1	20	17.5	19	19.1	18.4	18.9	19.4
% Transient ΔU (on-load 4/4) AREP+ - P.F.: 0.8 _{LAG}	15.4	15.5	15.4	13.6	14.6	14.7	14.3	15.2	15.7
W No-load losses	738	732	784	887	887	907	1062	1161	1129
W Heat dissipation	3056	3198	3582	3240	3944	4296	4682	5461	5649

* P.F. = 0.6

Reactances (%). Time constants (ms) - Class H / 480 V

	A	B	C	D	E	F	G	H	J
Kcc Short-circuit ratio	0.47	0.44	0.42	0.46	0.41	0.38	0.41	0.38	0.4
Xd Direct-axis synchronous reactance unsaturated	270	280	292	257	292	308	295	316	310
Xq Quadrature-axis synchronous reactance unsaturated	138	143	148	131	149	157	150	161	158
T'do No-load transient time constant	786	813	861	944	944	980	998	1031	962
X'd Direct-axis transient reactance saturated	17.2	17.2	16.9	13.6	15.5	15.7	14.7	15.3	16.1
T'd Short-circuit transient time constant	50	50	50	50	50	50	50	50	50
X''d Direct-axis subtransient reactance saturated	8.6	8.6	8.4	6.8	7.7	7.8	7.3	7.6	8
T''d Subtransient time constant	5	5	5	5	5	5	5	5	5
X''q Quadrature-axis subtransient reactance saturated	12.1	12.1	12	9.7	11	11.2	10.5	10.9	11.5
Xo Zero sequence reactance	0.71	0.71	0.7	0.56	0.64	0.65	0.61	0.63	0.67
X2 Negative sequence reactance saturated	10.37	10.4	10.24	8.27	9.39	9.55	8.97	9.3	9.8
Ta Armature time constant	8	8	8	8	8	8	8	8	8

Other class H / 480 V data

io (A) No-load excitation current SHUNT	0.65	0.62	0.61	0.58	0.58	0.55	0.6	0.53	0.55
io (A) No-load excitation current AREP+	0.99	0.95	0.93	0.89	0.89	0.84	0.92	0.82	0.85
ic (A) On-load excitation current SHUNT	2.19	2.18	2.23	1.94	2.19	2.22	2.32	2.14	2.24
ic (A) On-load excitation current AREP+	3.36	3.33	3.42	2.98	3.35	3.4	3.56	3.28	3.43
uc (V) On-load excitation voltage SHUNT	38	37.7	38.5	33.5	37.4	37.7	39.2	51.8	54
uc (V) On-load excitation voltage AREP+	24.5	24.3	24.8	21.6	24.1	24.3	25.3	33.3	34.7
ms Response time ($\Delta U = 20\%$ transient)	500	500	500	500	500	500	500	500	500
kVA Start ($\Delta U = 20\%$ cont. or $\Delta U = 30\%$ trans.) SHUNT*	45	48	58	79	79	88	104	119	119
kVA Start ($\Delta U = 20\%$ cont. or $\Delta U = 30\%$ trans.) AREP+*	70	75	90	124	124	137	161	171	172
% Transient ΔU (on-load 4/4) SHUNT - P.F.: 0.8 _{LAG}	20.7	20.7	20.5	18	19.4	19.6	18.9	19.3	20
% Transient ΔU (on-load 4/4) AREP+ - P.F.: 0.8 _{LAG}	15.9	15.9	15.7	14	15	15.1	14.6	15.6	16.1
W No-load losses	1049	1046	1120	1269	1269	1299	1512	1651	1600
W Heat dissipation	3592	3754	4173	3858	4610	5050	5477	6379	6556

* P.F. = 0.6

Transient voltage variation 400V - 50 Hz

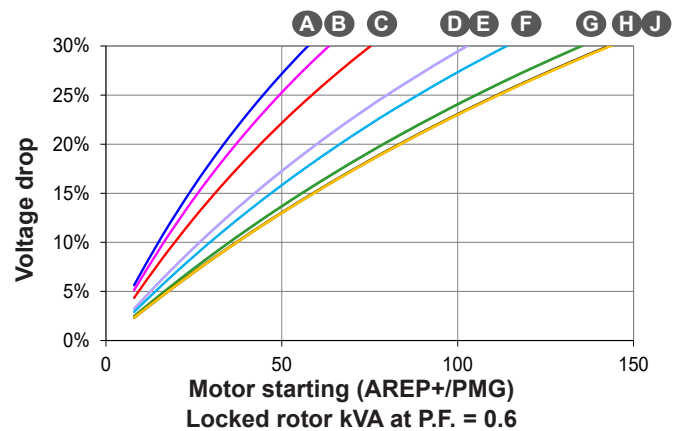
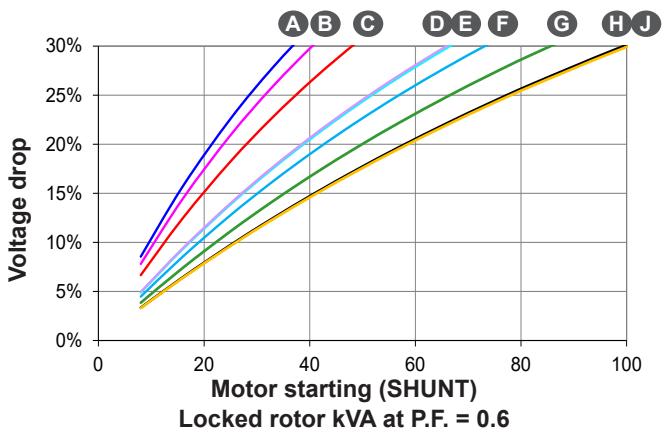
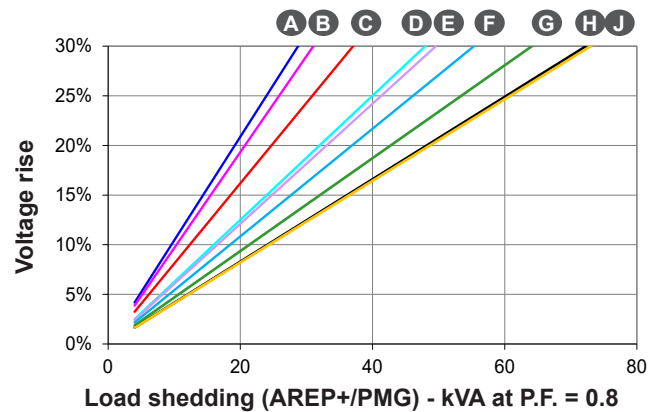
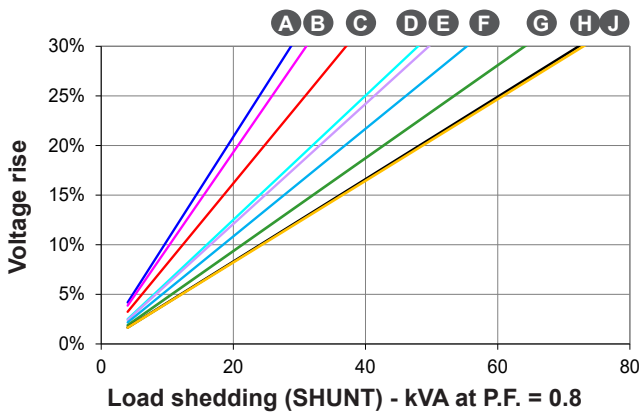
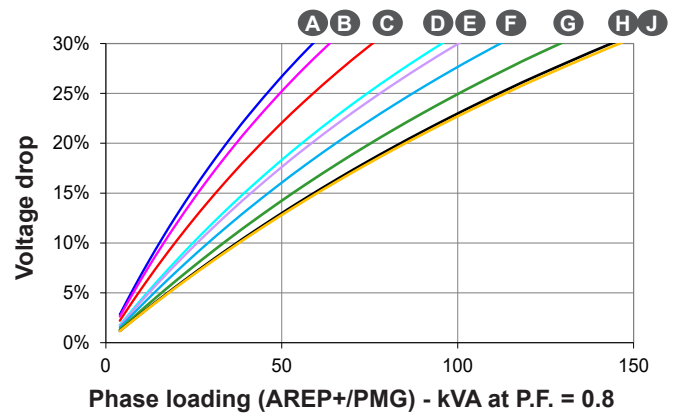
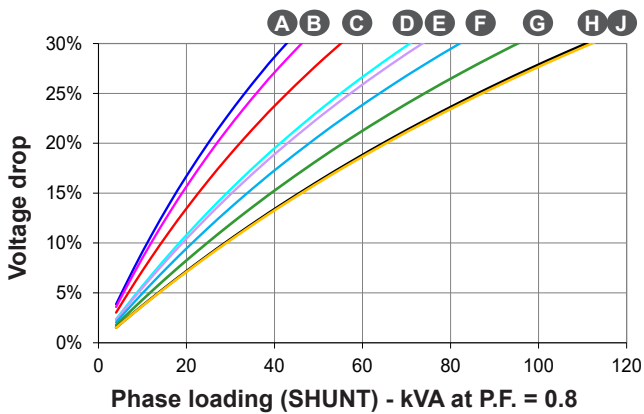

- 1) For a starting P.F. other than 0.6, the starting kVA must be multiplied by $K = \text{Sine P.F.} / 0.8$
- 2) For voltages other than 400V (Y), 230V (Δ) at 50 Hz, then kVA must be multiplied by $(400/U)^2$ or $(230/U)^2$.

Transient voltage variation 480V - 60 Hz

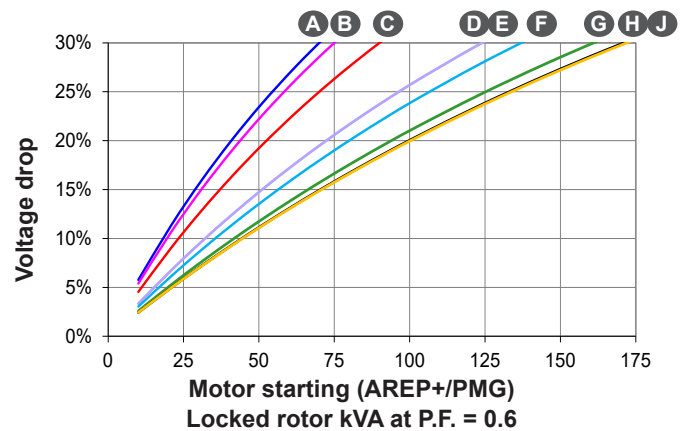
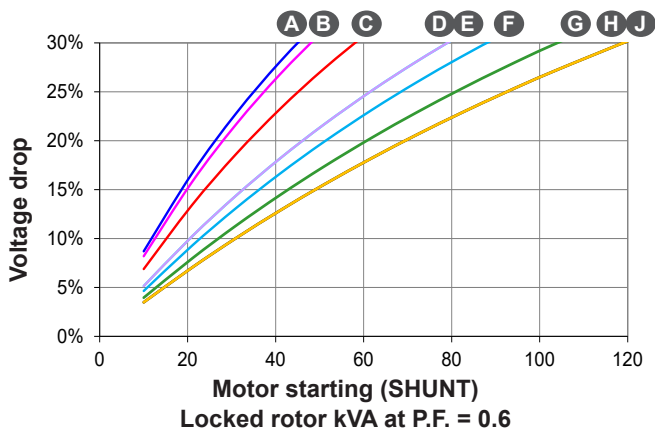
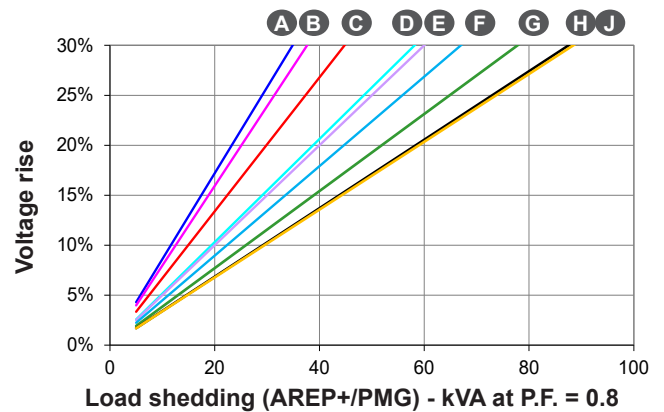
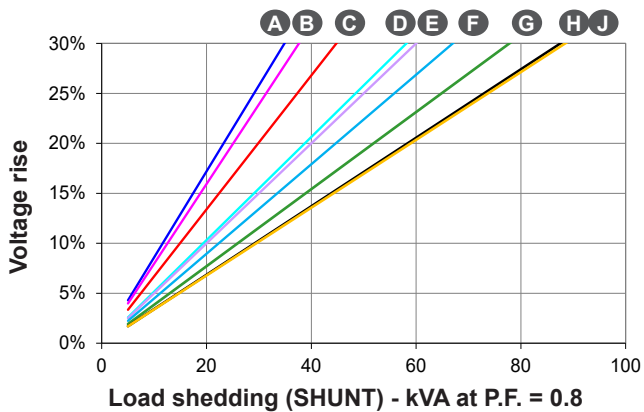
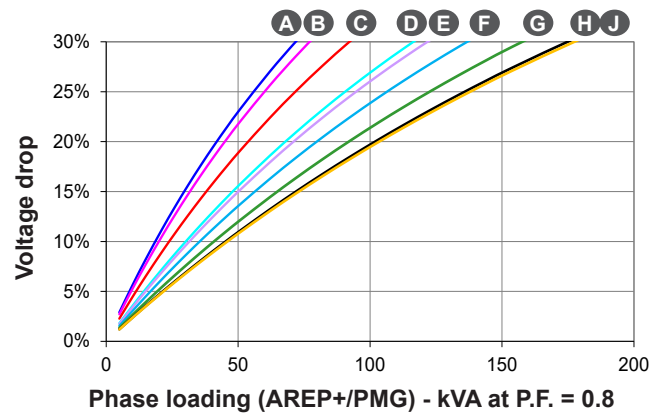
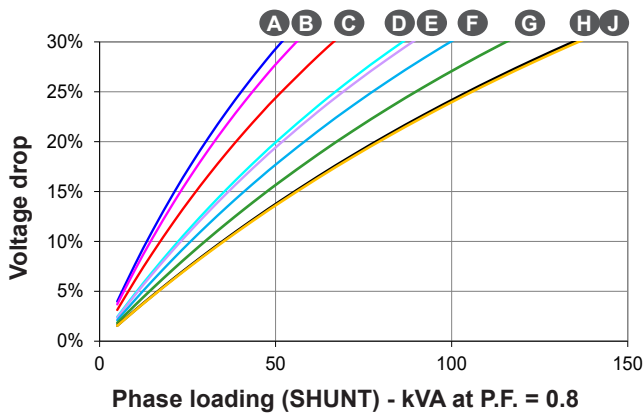

- 1) For a starting P.F. other than 0.6, the starting kVA must be multiplied by $K = \text{Sine P.F.} / 0.8$
- 2) For voltages other than 480V (Y), 277V (Δ), 240V (YY) at 60 Hz, then kVA must be multiplied by $(480/U)^2$ or $(277/U)^2$ or $(240/U)^2$.

3-phase short-circuit curves at no load and rated speed (star connection Y)

TAL 042 A

Symmetrical —
Asymmetrical - - -

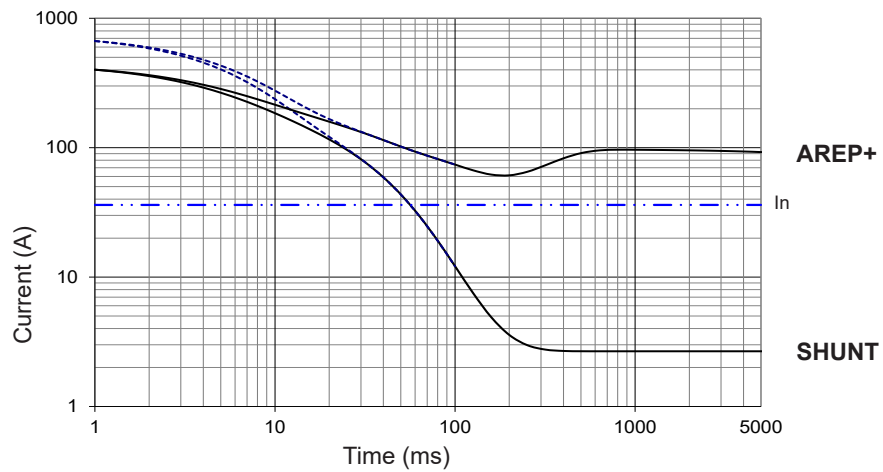

TAL 042 B

Symmetrical —
Asymmetrical - - -

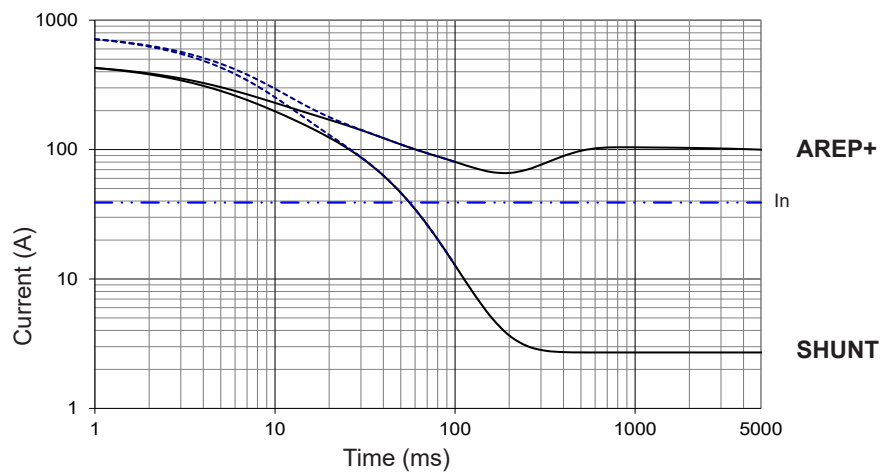

TAL 042 C

Symmetrical —
Asymmetrical - - -

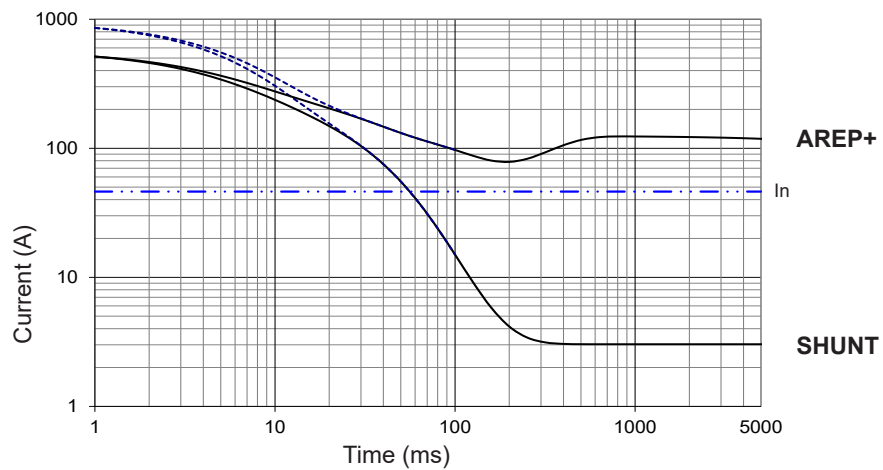

Influence due to connection

For (Δ) connection, use the following multiplication factor:
- Current value x 1.732.

3-phase short-circuit curves at no load and rated speed (star connection Y)

TAL 042 D

Symmetrical —
Asymmetrical - - -

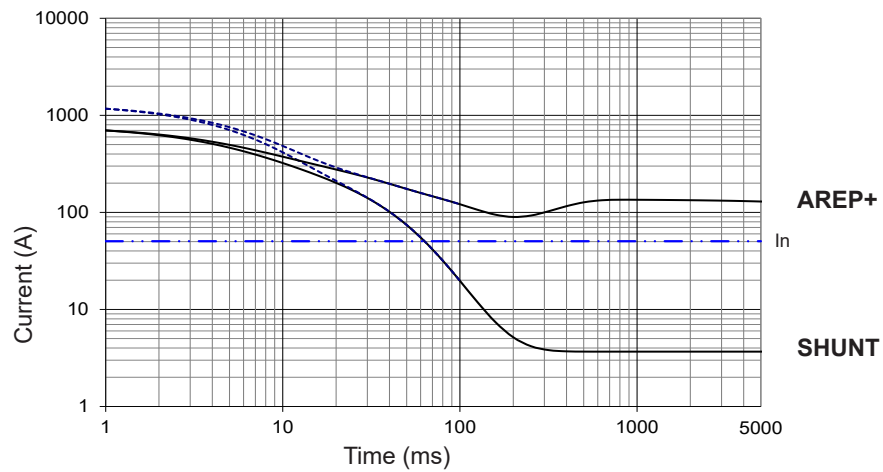

TAL 042 E

Symmetrical —
Asymmetrical - - -

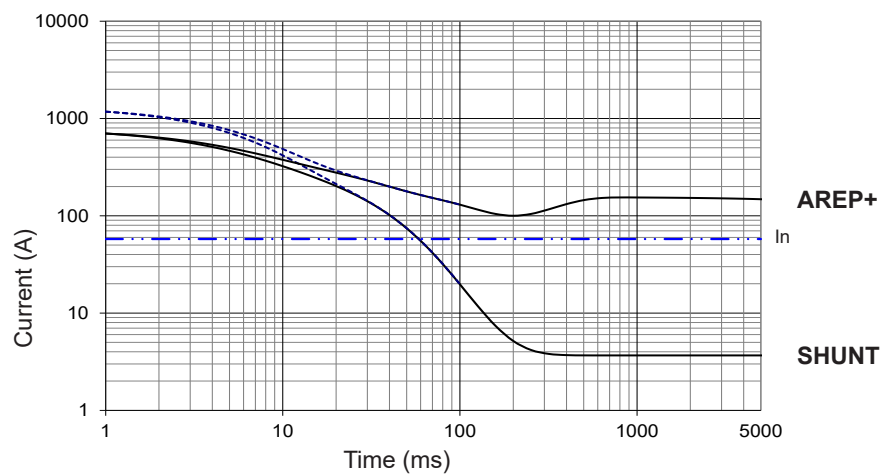

TAL 042 F

Symmetrical —
Asymmetrical - - -

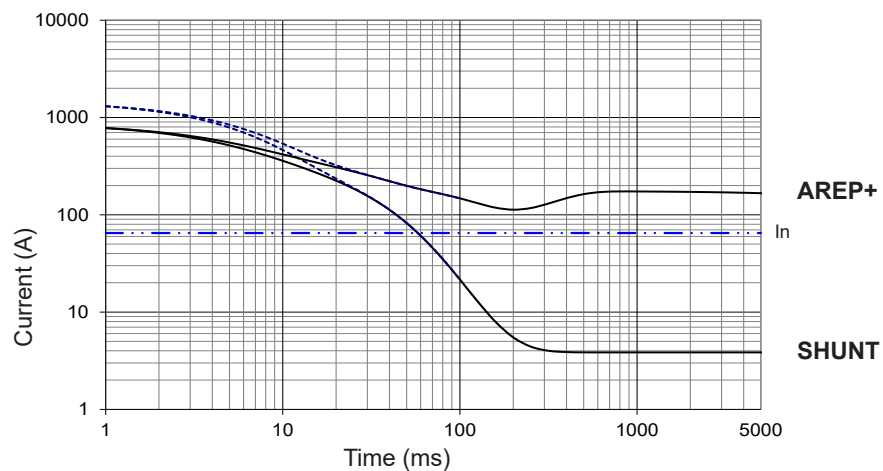

Influence due to short-circuit

Curves are based on a three-phase short-circuit.
For other types of short-circuit,
use the following multiplication factors.

	3 - phase	2 - phase L / L	1 - phase L / N
Instantaneous (max.)	1	0.87	1.3
Continuous	1	1.5	2.2
Maximum duration (AREP+/PMG)	1	1.5	

3-phase short-circuit curves at no load and rated speed (star connection Y)

TAL 042 G

Symmetrical —
Asymmetrical - - -

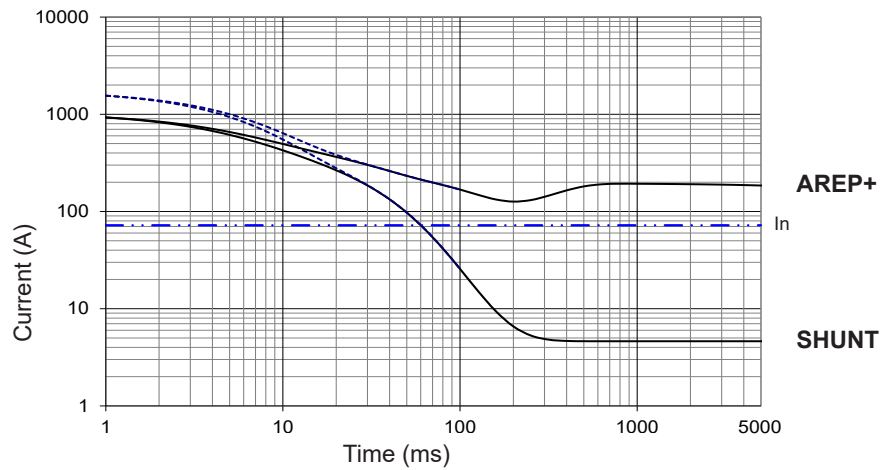

TAL 042 H

Symmetrical —
Asymmetrical - - -

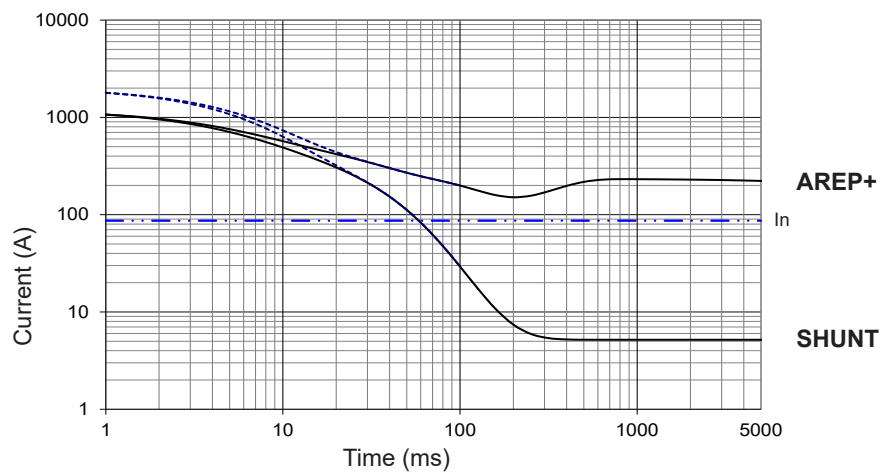

TAL 042 J

Symmetrical —
Asymmetrical - - -

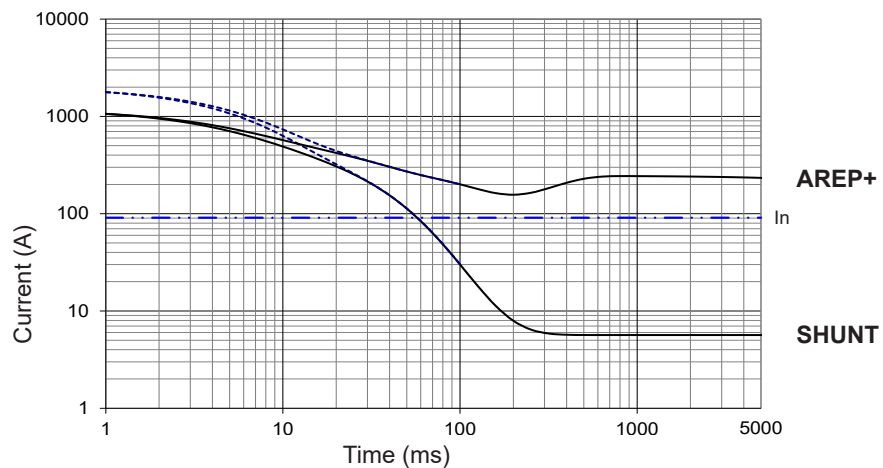

Influence due to connection

For (Δ) connection, use the following multiplication factor:

- Current value x 1.732.

Influence due to short-circuit

Curves are based on a three-phase short-circuit.

For other types of short-circuit, use the following multiplication factors.

	3 - phase	2 - phase L / L	1 - phase L / N
Instantaneous (max.)	1	0.87	1.3
Continuous	1	1.5	2.2
Maximum duration (AREP+/PMG)	1	1.5	



TAL 042 - Dedicated single-phase 18 to 42 kVA - 50 Hz / 23 to 53 kVA - 60 Hz

General characteristics

Insulation class	H	Excitation system	SHUNT
Winding pitch	2/3 (wind. M 50 Hz, M1 60 Hz)	AVR type	R121
Number of wires	4	Voltage regulation (*)	± 1 %
Protection	IP 23	Total Harmonic Distortion THD (**) in no-load	< 3.5 %
Altitude	≤ 1000 m	Total Harmonic Distortion THD (**) in linear load	< 5 %
Overspeed	2250 R.P.M.	Waveform: NEMA = TIF (**)	< 100
Air flow	0.10 m³/s (50 Hz) / 0.13 m³/s (60 Hz)	Waveform: I.E.C. = FHT (**)	< 2 %



(*) Steady state (**) Total harmonic distortion between phases, no-load or on-load (non-distorting)

Ratings / Efficiencies 50 Hz - 1500 R.P.M. - Winding M

kVA / kW - P.F. = 1(*)						
Duty / T° C	Continuous / 40 °C			Stand-by / 40 °C	Stand-by / 27 °C	
Class / T° K	H / 125° K	F / 105° K	H / 150° K	H / 163° K		
Serie (SE) 	230 V	η %	230 V	230 V	230V	η %
Parallel (PA) 	115 V	η %	115 V	115 V	115 V	η %
TAL 042 A	18	88.1	16.5	19	20	87.4
TAL 042 B	20.5	88.1	18.5	21.5	22.5	87.4
TAL 042 C	22.5	89	20.5	24	25	88.4
TAL 042 D	25	90.6	23	26.5	27.5	90.2
TAL 042 E	28	90.1	25.5	29.5	31	89.6
TAL 042 F	31.5	90.3	28.5	33.5	34.5	89.8
TAL 042 G	35	90.4	32	37	38.5	89.9
TAL 042 H	42	90.5	38	44.5	46	90

(*) For P.F. 0.8: derating 15%

Ratings / Efficiencies 60 Hz - 1800 R.P.M. - Winding M1

kVA / kW - P.F. = 1(*)						
Duty / T° C	Continuous / 40 °C			Stand-by / 40 °C	Stand-by / 27 °C	
Class / T° K	H / 125° K	F / 105° K	H / 150° K	H / 163° K		
Serie (SE) 	240 V	η %	240 V	240 V	240V	η %
Parallel (PA) 	120 V	η %	120 V	120 V	120 V	η %
TAL 042 A	23	88.3	21	24.5	25.5	87.7
TAL 042 B	26	88.3	23.5	27.5	28.5	87.6
TAL 042 C	29	89	26	30.5	32	88.5
TAL 042 D	31.5	90.4	28.5	33.5	34.5	90
TAL 042 E	36	89.8	33	38	39.5	89.2
TAL 042 F	40	90	36.5	42.5	44	89.5
TAL 042 G	47	90	43	50	51	89.5
TAL 042 H	53	90.5	48	56	58	90

(*) For P.F. 0.8: derating 15%

Starting motor 230V - 50Hz

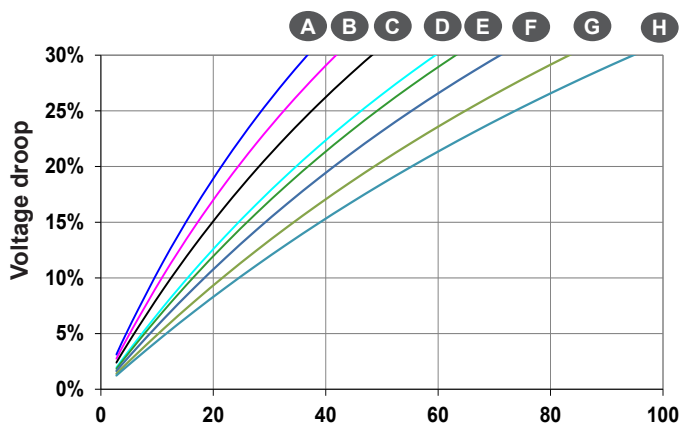

Starting motor 240V - 60Hz

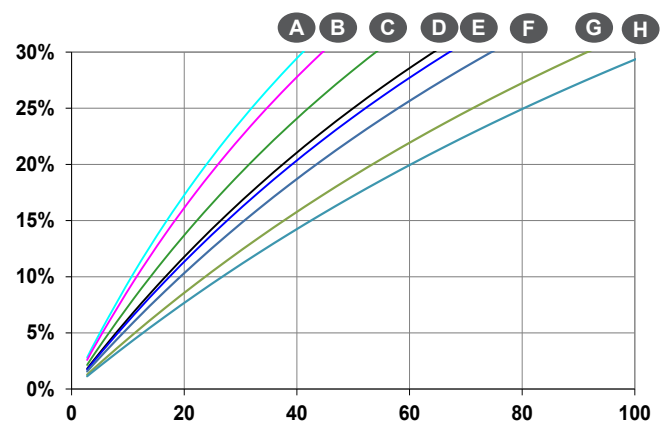

Locked rotor kVA at PF : 0.9

Single-bearing dimensions

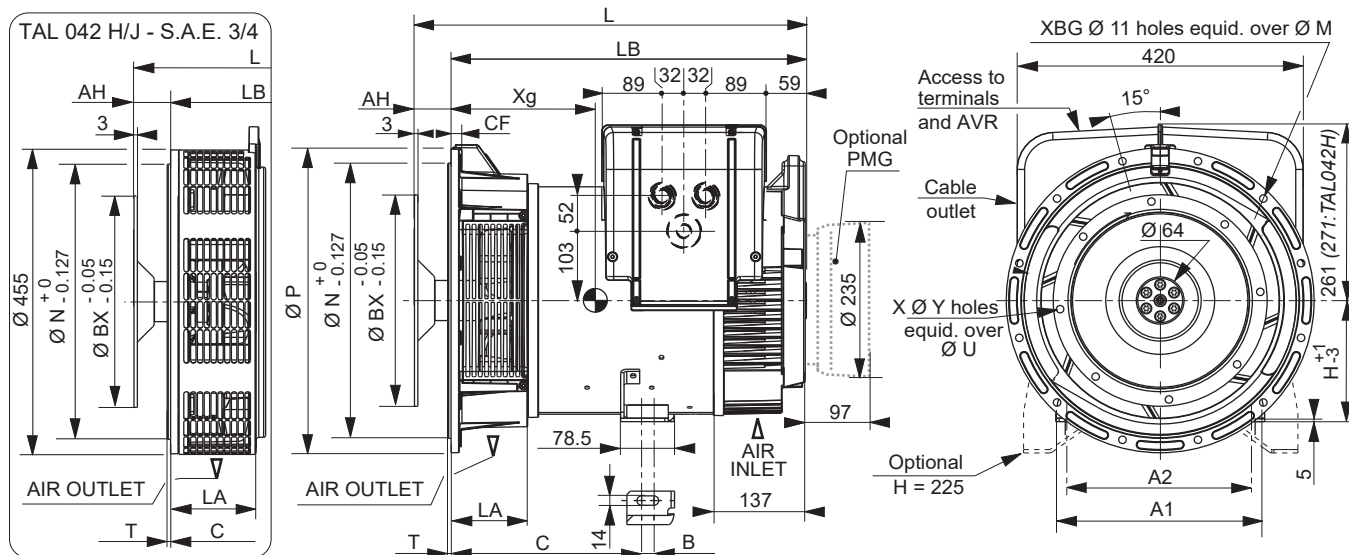

Dimensions (mm) and weight				H = 180 (Standard)				H = 225 (Option)				Coupling				
Type	L without PMG maxi*	LB	Xg	Weight (kg)	C	B	A1	A2	C	B	A1	A2	Flange	2	3	4
TAL 042 A	565	503	237	117	260	18	307	279	299	23	400	356	Flex plate			
TAL 042 B	565	503	242	122	260	18	307	279	299	23	400	356	11 1/2	x	x	-
TAL 042 C	565	503	252	133	260	18	307	279	299	23	400	356	10	x	x	x
TAL 042 D/E	610	548	275	165	260	18	307	279	312.5	23	400	356	8	-	x	x
TAL 042 F	650	588	287	181	260	18	307	279	312.5	23	400	356	7 1/2	-	x	x
TAL 042 G	650	588	295	186	260	18	307	279	312.5	23	400	356				
TAL 042 H/J**	680	618	310	187	260	18	307	279	312.5	23	400	356				
TAL 042 H/J***	703	641	300	195	283	18	307	279	335.5	23	400	356				

* L maxi = LB + AH maxi ** S.A.E. 3 *** S.A.E. 4

Flange (mm)								Flex plate (mm)					
S.A.E.	P	N	M	XBG	T	LA	CF	S.A.E.	BX	U	X	Y	AH
4	406/455*	361.95	381	12	5*6	122/128.3*	15/16*	11 1/2	352.42	333.38	8	11	39.6
3	452	409.58	428.62	12	5	105.3*/112.5	12	10	314.32	295.28	8	11	53.8
2	490	447.675	466.725	12	6	111	12	8	263.52	244.48	6	11	62
								7 1/2	241.3	222.25	8	9	30.2

* Specific dimension TAL 042 H/J

Torsional analysis data

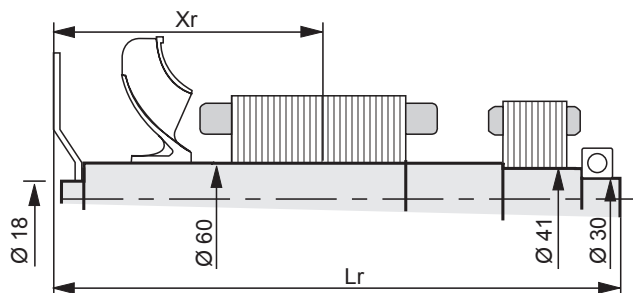

Centre of gravity: Xr (mm), Rotor length: Lr (mm), Weight: M (kg), Moment of inertia: J (kgm ²): (4J = MD ²)																
Flex plate	S.A.E. 7 1/2				S.A.E. 8				S.A.E. 10				S.A.E. 11 1/2			
	Xr	Lr	M	J	Xr	Lr	M	J	Xr	Lr	M	J	Xr	Lr	M	J
TAL 042 A	270.32	526.2	45.88	0.1966	296.15	558	46.74	0.2023	285.63	549.8	41.17	0.2128	270.67	535.6	47.41	0.2258
TAL 042 B	272.98	526.2	47.78	0.2076	298.99	558	48.64	0.2133	288.54	549.8	49.07	0.2238	273.6	535.6	49.31	0.2368
TAL 042 C	278.76	526.2	51.87	0.2297	305.13	558	52.73	0.2354	294.8	549.8	53.16	0.2459	279.89	535.6	53.4	0.2589
TAL 042 D/E	300.94	571.2	62.16	0.2809	327.89	603	63.02	0.2866	317.75	594.8	63.45	0.2971	302.87	580.6	63.69	0.31
TAL 042 F	315.61	611.2	68.24	0.3086	342.8	643	69.1	0.3143	332.74	634.8	69.53	0.3248	317.87	620.6	69.77	0.3378
TAL 042 G	320.71	611.2	71.24	0.3251	348.04	643	72.1	0.3308	338.02	634.8	72.53	0.3413	323.16	620.6	72.77	0.3543
TAL 042 H/J	338.23	641.2	79.59	0.3693	365.83	673	80.45	0.375	356.27	664.8	80.88	0.3855	341.06	650.6	81.12	0.3985

NOTE : Dimensions are for information only and may be subject to modifications. The torsional analysis of the transmission is imperative. All values are available upon request.



www.nidecpower.com

Connect with us at:



© 2025 Moteurs Leroy-Somer SAS. The information contained in this brochure is for guidance only and does not form part of any contract. The accuracy cannot be guaranteed as Moteurs Leroy-Somer SAS have an ongoing process of development and reserve the right to change the specification of their products without notice.

Moteurs Leroy-Somer SAS. Headquarters: Bd Marcellin Leroy, CS 10015, 16915 Angoulême Cedex 9, France. Share Capital: 32,239,235 €, RCS Angoulême 338 567 258.