

D550

Digital Voltage Regulator

**This manual concerns the alternator AVR which you have just purchased.
We wish to draw your attention to the contents of this maintenance manual.**

SAFETY MEASURES

Before using your machine for the first time, it is important to read the whole of this installation and maintenance manual.

All necessary operations and interventions on this machine must be performed by a qualified technician.

For field applications relative to for instance nonlinear loads, transformers magnetizations or huge load impacts and load shedding, it is highly recommended to contact our technical support service in order to fine tune the factory settings of the voltage regulator.

Our technical support service will be pleased to provide any additional information you may require.

The various operations described in this manual are accompanied by recommendations or symbols to alert the user to potential risks of accidents. It is vital that you understand and take notice of the following warning symbols.

WARNING

Warning symbol for an operation capable of damaging or destroying the machine or surrounding equipment.



Warning symbol for general danger to personnel.



Warning symbol for electrical danger to personnel.



All servicing or repair operations performed on the AVR should be undertaken by personnel trained in the commissioning, servicing and maintenance of electrical and mechanical components.

WARNING

**This AVR can be incorporated in a EC-marked machine.
This manual is to be given to the end user.**

© 2024 Moteurs Leroy-Somer SAS

Share Capital: 32,239,235 €, RCS Angoulême 338 567 258.

We reserve the right to modify the characteristics of this product at any time in order to incorporate the latest technological developments. The information contained in this document may therefore be changed without notice.

This document may not be reproduced in any form without prior authorization.

All brands and models have been registered and patents applied for.

D550

Digital Voltage Regulator

Table of contents

0. TERMS AND EXPRESSIONS.....	6
1. General Instructions.....	7
1.1. Identity sheet.....	7
1.2. General overview of the product.....	7
1.3. Technical characteristics.....	8
1.3.1. Component.....	8
1.3.2. Operating values.....	9
1.4. Safety devices and general warning symbols.....	12
1.5. General information.....	13
1.6. Use.....	13
1.7. Transportation and storage.....	13
1.8. Installation.....	13
1.9. Electrical connection.....	14
1.10. Operation.....	14
1.11. Service and maintenance.....	14
1.12. Protection of component.....	14
2. Mounting and connection instructions.....	15
2.1. Layout of the space housing the AVR.....	15
2.2. Warning symbols for the installation.....	15
2.3. Connections.....	16
2.4. Wiring precautions.....	25
3. Description of operating running modes.....	26
3.1. Regulation modes.....	26
3.2. Control of modes and information.....	29
3.3. Protection functions.....	29
3.4. Related functions.....	29
4. Communication.....	29
4.1. USB.....	29
4.2. CAN.....	30
4.3. LED.....	30
5. Setting instructions.....	31
5.1. PC Software.....	31
5.1.1. Software Installation.....	31
5.1.2. Different access levels of Easyreg Advanced.....	33
5.1.3. Description of the banner and tabs.....	34
5.1.4. Communication with the D550.....	36
5.1.5. Description of the “Configuration” window.....	36
5.1.6. “Oscilloscope” window.....	42
5.1.6.1. Curves.....	42
5.1.6.2. Trigger.....	44
5.1.6.3. Cursors.....	45
5.1.6.4. Transient test.....	46
5.1.6.5. Open a curve or an oscilloscope display configuration.....	47
5.1.6.6. Save a curve or an oscilloscope display configuration.....	47

D550

Digital Voltage Regulator

5.1.6.7. Change the background of the grid plotting area and the thickness of the curves	47
5.1.7. "Monitor" window.....	48
5.1.7.1. Display units.....	48
5.1.7.2. Graph.....	49
5.1.7.3. Gauges	49
5.1.7.4. Capability curve.....	50
5.1.7.5. I/O.....	50
5.1.7.6. Temperatures.....	51
5.1.7.7. Synchronization	51
5.1.7.8. AVR status and faults.....	51
5.1.7.9. Fresnel diagram	52
5.1.7.10. CT phase shift.....	52
5.1.7.11. Change the size of an object.....	52
5.1.7.12. Delete an object	53
5.1.7.13. Save a monitor configuration.....	53
5.1.7.14. Open a monitor configuration	54
5.2. Create a new configuration.....	54
5.2.1. Description of the "quick" alternator configuration.....	55
5.2.2. Description of the "advanced" alternator configuration	56
5.2.3. AVR wiring	57
5.2.4. Capability curve limit	60
5.2.5. Definition of the over excitation limit	61
5.2.6. Definition of the stator current limit.....	61
5.2.7. Definition of the protection functions.....	63
5.2.8. Regulation mode.....	68
5.2.8.1. Starting	68
5.2.8.2. Voltage regulation	71
5.2.8.3. Voltage matching circuit	75
5.2.8.4. Regulation of the generator power factor	76
5.2.8.5. Regulation of generator kVAr	78
5.2.8.6. Regulation of power factor at one point of the grid	80
5.2.8.7. Regulation of the field current (manual mode).....	82
5.2.9. Setting the PID gains.....	84
5.2.10. I/O management.....	85
5.2.11. Curve functions	86
5.2.11.1. Overview	86
5.2.11.2. Examples curve functions	87
5.2.12. User PID gain	87
5.2.13. Logic/analog gates	87
5.2.13.1. Overview	87
5.2.13.2. Examples of gate programming.....	90
5.2.14. Log event	92
5.2.15. Second configuration	93
5.2.16. Synchronization	94
5.2.17. Grid code.....	96
5.2.17.1. Voltage support.....	96
5.2.17.2. Grid code profile monitoring	97
5.2.17.3. Stator current monitoring.....	98
5.2.17.4. Pole slipping monitoring	98
5.3. Comparison window	99
5.4. Print reports.....	100

D550

Digital Voltage Regulator

5.5. Excel Export.....	100
6. Maintenance instructions.....	102
6.1. Warning symbols for maintenance	102
6.2. Preventive maintenance instructions	102
6.3. Anomalies and incidents	102
6.4. Replacing a faulty AVR	104
7. Recycling instructions	105
8. APPENDIX	106
8.1. Vector permutations.....	106
8.2. AVR regulation mode priority	108

D550

Digital Voltage Regulator

0. TERMS AND EXPRESSIONS

VT	Voltage transformer, in this manual a voltage transformer is used both for the power supply and for measuring the voltage.
CT	Current transformer, used for measuring the current.
PMG	Permanent Magnet Generator.
AREP	Auxiliary windings installed in the machine which are used to supply the AVR with power. They often consist of 2 windings: the first "H1" which is affected by voltage variations, the second "H3" which is affected by current variations.

D550

Digital Voltage Regulator

1. General Instructions

1.1. Identity sheet

The D550 AVR is designed by:

Moteurs Leroy-Somer SAS
Boulevard Marcellin Leroy, CS 10015
16915 ANGOULEME Cedex 9, France
Tel.: +33 2 38 60 42 00

Reference Leroy-Somer™: 40041384

1.2. General overview of the product

This manual describes how to install, use, set up and maintain the D550 AVR.

The purpose of this AVR is to regulate alternators with a field current of less than or equal to 7A in continuous operations, and 15A maximum in the event of short-circuit for 10 seconds maximum.¹

It is designed for mounting in a generator terminal box or a control cabinet. It must be installed in compliance with local protection and safety standards, especially those specific to electrical installations with a maximum voltage of 300Vac phase/neutral.

It takes the form of a compact unit with a set of connectors and USB on the front.

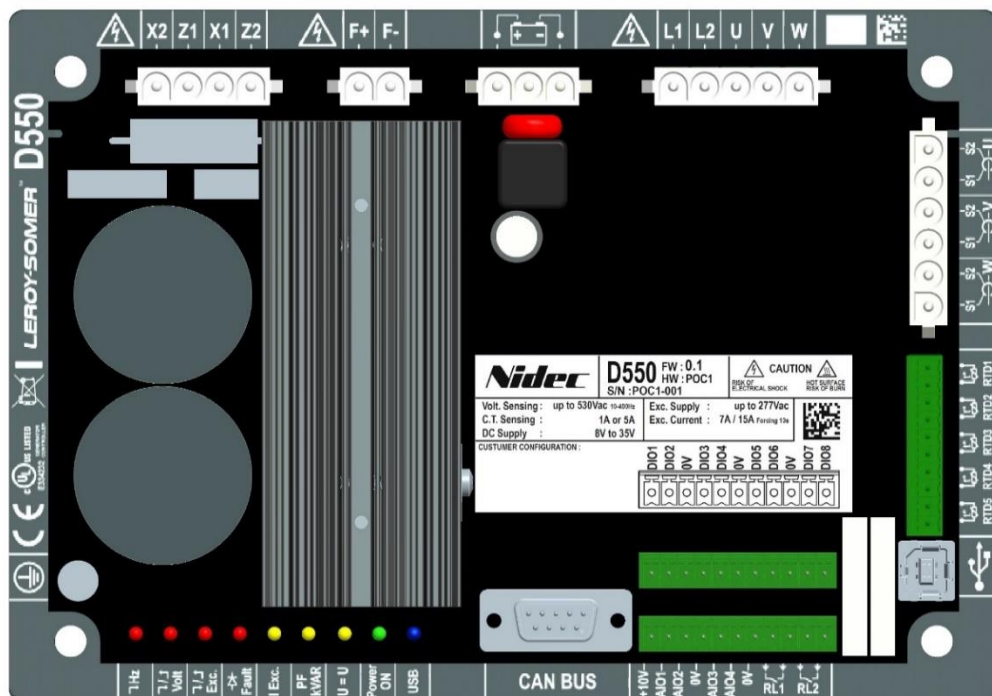

¹ These values are given for a temperature of 70°C. See the detailed technical specification for the full range of values.

D550

Digital Voltage Regulator

The D550 AVR consists of several function blocks:

- A power bridge (that supplies the field current)
- A measuring circuit for the various signals such as voltages, currents
- A set of digital and analog I/O: for control of regulation modes, operating information, correcting references
- A set of connectors
- A set of communication modes for dialogue and remote parameter-setting

Various additional features are integrated in the D550:

- 5 measurement inputs for Pt100 or CTP temperature sensors
- 1 incremental encoder input for the rotor angular position with Easy Log PS option
- 1 CAN BUS connector
- 1 USB connector

1.3. Technical characteristics

1.3.1. Component

The D550 AVR is a digital voltage regulator used to control the alternator field current using separate control loops. The regulation mode is managed either by parameter-setting, or via the D550 digital inputs or via the communication mode.

These regulation modes are:

- Voltage regulation
 - With or without quadrature droop to allow parallel machine operation (1F)
 - With or without cross-current compensation
 - With or without load compensation²
- Matching of the machine voltage and grid voltage prior to connection to a grid (called “3F” or “U=U”)
- Power factor regulation, only when the alternator is connected to a grid (2F)
- Reactive power (kVAr) regulation, only when the alternator is connected to a grid
- Regulation of cos phi at the installation delivery point within the drive system capacity, from an analog input (remote measurement mode by a converter supplied by the customer) or by directly calculating the power factor at the delivery point.³
- Regulation of the field current, or manual mode, which allows direct control of the field current value

² Quadrature droop, cross-current and load compensation cannot be enabled at the same time and require the use of a current transformer. Cross current requires the use of an additional CT.

³ Obligation to have the Grid code VTs and Grid code current measurement CT placed at the delivery point and wired on the D550.

D550

Digital Voltage Regulator

The D550 can also be used to:

- Adjust the reference for the regulation mode in progress, using:
 - up/down volt-free contacts
 - an analog input (4-20 mA, 0-10V, $\pm 10V$, potentiometer 1k Ω)
- Monitor 5 temperature sensors (Pt100 or CTP)
- Limit the minimum field current delivered to the exciter field
- Limit the maximum stator current
- Detect loss of phase
- Withstand a sudden short-circuit for 10 seconds maximum in AREP or PMG
- Protect the alternator in the event of a rotating diode failure
- Monitor (trips) and support electrical networks (Grid Code)
- Monitor and log events (faults, limits, etc.)
- Record signals (oscilloscope feature with the utility SW)
- Define a user interface screen with measurement indicators and states (monitor function)

The various data items of faults, regulation modes or measurements can be delivered to the 8 digital configurable outputs and/or 4 analog configurable outputs (4-20 mA, 0-10 V, ± 10 V).

1.3.2. Operating values

- **Alternator voltage measurement:**
 - 2 phases or 3 phases 530Vac rms max.
 - Consumption < 2VA
- **Grid code voltage measurement:**
 - 2 phases 530Vac rms max.
 - Consumption < 2VA
- **Stator current measurement by CT:**
 - 1 or 3 phases
 - Range 0-1A or 0-5A (300 % max. 30s)
 - Consumption < 2VA
- **AC power supply:**
 - 4 terminals for PMG, AREP, SHUNT
 - 2 independent circuits
 - Range 50-277Vac (115 % max. 2 minutes)
 - Max. consumption < 3000VA
- **Field excitation:**
 - Rated 7A at 70°C max. – 8A at 55°C
 - Short-circuit 15A max. for 10 seconds
 - Field winding resistance > 4 ohms
- **DC auxiliary supply:**
 - Range 8-35Vdc (rated power: 12V or 24V)
 - Consumption < 1A
- **Frequency measurement:**
 - Range 30-400 Hz

D550

Digital Voltage Regulator

- **Regulation accuracy:**
 - +/-0.25% of the average of the three phases with harmonic distortion less than 20%
 - +/-0.5% of the average of the three phases with harmonic distortion from 20% up to 40% (harmonics associated to six-thyristors load type)
- **Voltage adjustment range:** 0 to 150% of the rated voltage (can be controlled via internal setpoint, volt-free contacts, analog input or CANBUS)
- **Quadrature droop adjustment range:** -20% to 20%
- **Under frequency protection:** threshold adjustable in increments of 0.1 Hz, adjustable slope $k \times V/Hz$ where $0.5 < k < 5$
- **Assistance with load reconnection for the prime mover:** LAM, gradual increase, etc.
- **Excitation ceiling:** limiting via thermal model adjustable by configuration at 3 points
- **Environment:** mounted in a cabinet or terminal box
 - Operating conditions: ambient temperatures from -40°C to +70°C, relative humidity less than 95%, non-condensing
 - Storage conditions: ambient temperatures from -55°C to +85°C, relative humidity less than 95%, non-condensing
 - Vibration: 2.0 Hz to 25 Hz – amplitude ± 1.6 mm; 25 Hz to 100 Hz – acceleration ± 4.0 g
- **Weight:** 850g
- **AVR parameters:** set using software EasyReg Advanced (available for download) or via the CANBUS communication interface
- **Conformity to standards:**
 - EMC: IEC 61000-6-2, IEC 61000-6-4
 - Safety: IEC 61010-1 (CAT III, Pol.2)
 - Environment: IEC 60068-1
 - Dry heat: IEC 60068-2-2
 - Damp heat: IEC 60028-2-30 and IEC 60068-2-78
 - Cold: IEC 60068-2-1
 - Thermal cycling: IEC 60068-2-14
 - Vibration, shock: IEC 60068-2-6 and IEC 60068-2-27
- **Approvals:**
 - UL (USA, Canada), EC

D550

Digital Voltage Regulator

- **Dimensions:**

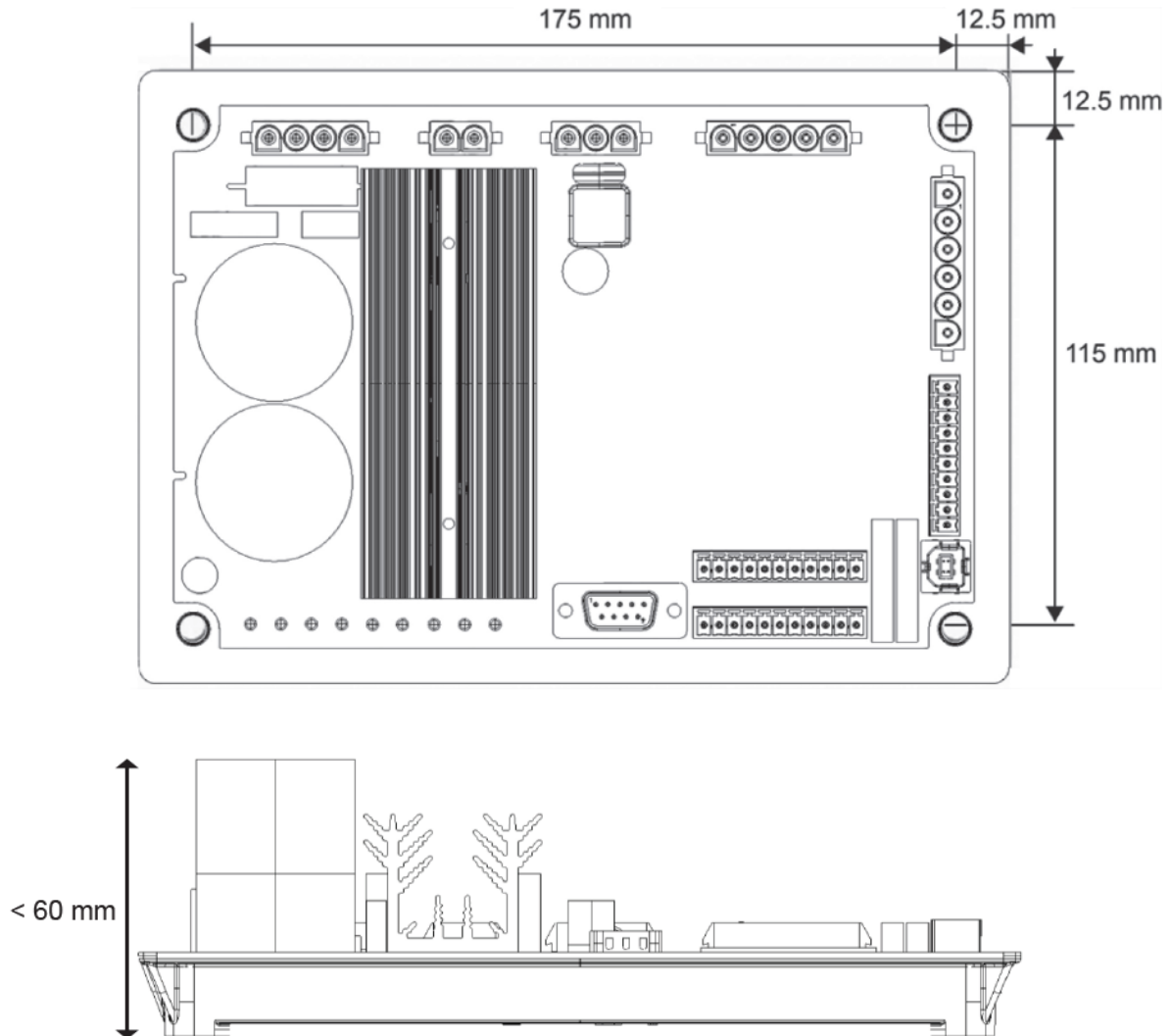

When mounting the AVR in a cabinet, it must be positioned to allow air to circulate freely in the heatsink and around the product. It is therefore recommended that the AVR is mounted horizontally at the base of the cabinet so that the heatsink is positioned vertically.

D550

Digital Voltage Regulator

1.4. Safety devices and general warning symbols

For the user's own safety, the D550 must be connected to an approved earth using the earth terminal shown below. The tooling for this connection is not included with the D550. The terminal is an M4 female terminal. A tightening torque of 1.2 N.m +/-0.2 N.m must be applied to the screw.

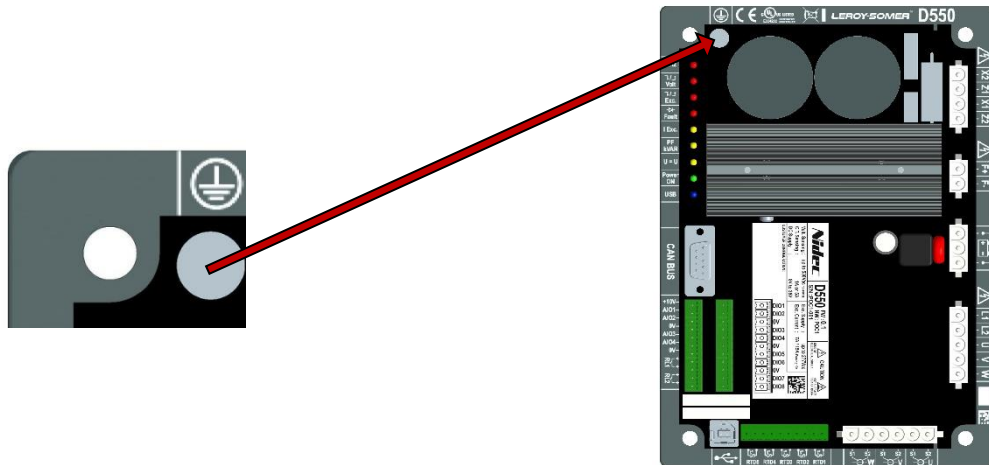

Note: All the 0V terminals on the electronic control board are connected to this earth terminal.

It is essential to comply with the power connection diagrams recommended in this manual.

The D550 includes devices which, in the event of problems, can de-energize or over excite the generator. The generator itself can also become jammed for mechanical reasons. Finally, voltage fluctuations or power cuts may also cause the unit to stop.

The D550 is designed to be integrated in an installation or electrical machine and can under no circumstances be considered of the safety device. It is therefore the responsibility of the machine manufacturer, the designer of the installation or the user to take all necessary precautions to ensure that the system complies with current standards, and to provide any devices required to ensure the safety of the equipment and personnel (especially direct contact with connectors when the AVR is running).

Nidec Power declines all responsibility in the event of the above recommendations not being observed.

The various interventions described in this manual are accompanied by recommendations or symbols to alert the user to potential risks of accidents. It is vital that you understand and comply with the various warning symbols below.

- Throughout the manual, this symbol warns against consequences which may arise from inappropriate use of the AVR, since electrical risks may lead to material or physical damage as well as constituting a fire hazard.



D550

Digital Voltage Regulator

- This symbol warns of electrical danger to personnel:



1.5. General information

The D550 AVR may contain unprotected live parts, as well as hot surfaces, during operation. Unjustified removal of protection devices, incorrect use, faulty installation or inappropriate operation could represent a serious risk to personnel and equipment.

For further information, consult technical support.

All work relating to transportation, installation, commissioning and maintenance must be performed by experienced, qualified personnel (see IEC 364, CENELEC HD 384 or DIN VDE 0100, as well as national specifications for installation and accident prevention).

In these basic safety instructions, qualified personnel means persons competent to install, mount, commission and operate the product and possessing the relevant qualifications.

1.6. Use

D550 voltage regulators are components designed for integration in installations or electrical machines. When integrated in a machine, commissioning must not take place until it has been verified that the machine complies with directive 2006/42/EC (Machinery Directive). It is also necessary to comply with standard EN 60204, which stipulates in particular that electrical actuators (which include voltage regulators) cannot be considered as circuit-breaking devices and certainly not as isolating switches. Commissioning can take place only if the requirements of the Electromagnetic Compatibility Directive (EMC 2014/30/EU) are met.

The voltage regulators meet the requirements of the Low Voltage Directive 2014/35/EU. The harmonized standards of the DIN VDE 0160 series in connection with standard VDE 0660, part 500 and EN 60146/VDE 0558 are also applicable.

The technical characteristics and instructions concerning the connection conditions specified on the nameplate and in the documentation provided must be observed without fail.

1.7. Transportation and storage

All instructions concerning transportation, storage and correct handling must be observed.

The climatic conditions specified in this manual must be observed.

1.8. Installation

The installation and cooling of equipment must comply with the specifications in the documentation supplied with the product.

The D550 must be protected against excessive stress. In particular, there must be no damage to parts and/or modification of the clearance between components during transportation and handling. Avoid touching the electronic components and any live parts.

The D550 contains parts which are sensitive to electrostatic stress and may be easily damaged if handled incorrectly. Electrical components must not be exposed to mechanical damage or destruction (risks to health!). Consult technical support if you have any doubts concerning the product.

D550

Digital Voltage Regulator

1.9. Electrical connection

When work is performed on D550s which are powered up, national accident prevention specifications must be respected.

The electrical installation must comply with the relevant specifications (for example conductor cross-sections, protection via fused circuit-breaker, or/and connection of protective conductor). More detailed information is given in this manual.

Instructions for an installation which meets the requirements for electromagnetic compatibility, such as screening, earthing, presence of filters and correct insertion of cables and conductors, are also given in this manual. These instructions must be followed in all cases, even if the AVR carries the CE mark. Adherence to the limits given in the EMC legislation is the responsibility of the manufacturer of the installation or the machine.

For EU application: Instrument transformers shall provide basic insulation according to the requirements of IEC 61869-1, "Instrument transformers – Part 1: General requirements" and IEC 61869-2, "Additional requirements for current transformers".

For US application: Instrument transformers shall provide basic insulation according to the requirements of IEEE C57.13, "Requirements for Instrument Transformers," and IEEE C57.13.2, "Conformance Test Procedure for Instrument Transformers".

1.10. Operation

Installations incorporating D550s must be fitted with additional protection and monitoring devices as laid down in the current relevant safety regulations: law on technical equipment, accident prevention regulations, etc. Modifications to the D550 parameters using control software are permitted.

Active parts of the device and live power connections must not be touched immediately after the D550 is powered down, as the capacitors may still be charged. In view of this, the warnings fixed to the voltage regulators must be observed.

During operation, all doors and protective covers must be kept closed.

1.11. Service and maintenance

Refer to the manufacturer's documentation.

Our technical support service will be pleased to provide you with any additional information you may require.

This manual is to be given to the end user.

1.12. Protection of component

The AVR auxiliary power supply, which sources the product's internal power supplies, is essential for AVR operation. It must be protected by a 1A fast-acting fuse (Mersen 250FA 1A- E76491 or equivalent).

Similarly, the AVR AC power supplies, which generate the field current, must be protected by CC class fast-blow fuses (15A max.) or a listed circuit-breaker (10A max.).

D550

Digital Voltage Regulator

2. Mounting and connection instructions

2.1. Layout of the space housing the AVR

- Dimensions: see page 11

Four M5 or M6 screws are used to fix the AVR in position. These screws must be tightened to the rated torque of 2.5 Nm.

- Drill hole distances:
 - Height: 175 mm
 - Width: 115 mm
 - Diameter: 6 mm max.

The product has to be placed with enough space around the heat sink in order to have sufficient cooling.



When mounting the AVR in a cabinet, it must be positioned to allow air to circulate freely in the heatsink and around the product. It is therefore recommended that the AVR is mounted horizontally at the base of the cabinet so that the heatsink is positioned vertically.

Ventilation, cooling or even heating system may be needed to keep the AVR within the environmental limits described earlier.

Note: If you wish to integrate components which do not comply with the above minimum prerequisites, please consult technical support.

2.2. Warning symbols for the installation

[See section 1.4.](#)



While the AVR is running, do not unplug any connectors or make any wiring modifications, as this may lead to electric shock and/or destruction of the AVR and/or damage to the alternator.



The same goes for modifications to the main alternator settings, such as: machine data, voltage and current measurement transformer wiring, upper or lower reference limits, starting control, etc., which must be made when the alternator stopped.

The D550 operating ranges must always be adhered to. Changing the settings to inappropriate voltages or currents may cause partial or total destruction of the AVR and/or alternator.

The power input must be protected by a circuit-breaker or fuses in order to avoid irreparable damage to the AVR in the event of short-circuit or voltage surge. [See section 1.12.](#)

D550

Digital Voltage Regulator

2.3. Connections

The D550 must be connected to the various measurement, power and control signals to be able to perform its regulation functions:

- **Alternator voltage measurement:**

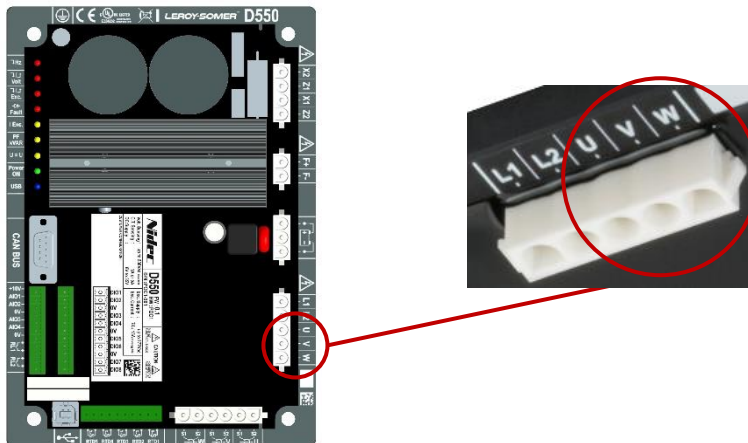

Figure 1: voltage sensing connection

Voltage transformers are mandatory if the alternator voltage measurement is higher than 480 Vac rms phase-to-phase (686 Vac rms maximum for 10 seconds).

Connection	Electrical schematic
Phase/Phase	

D550

Digital Voltage Regulator

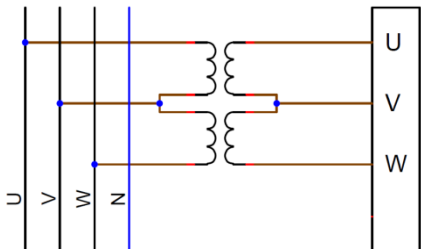
Connection	Electrical schematic
3-Phase	

Note: The software configuration for the alternator voltage and current measurement connections must be consistent with the wiring diagram on the alternator. If there is only one current transformer, it should be mounted on phase U or V. If this wiring is not complied with, the resulting power and power factor calculations will be incorrect. It also depends on the direction of rotation. If necessary, see the appendix for examples of vector permutations.

For greater accuracy, there are 2 possible measurement ranges (configured automatically according to the measured voltage):

Measurement ranges	
Low range	110 Vac RMS Max
High range	530 Vac RMS Max

- **Grid voltage measurement:**

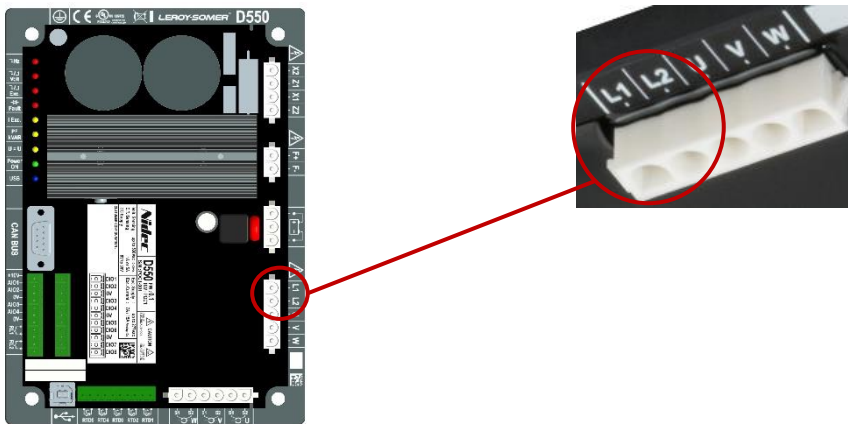
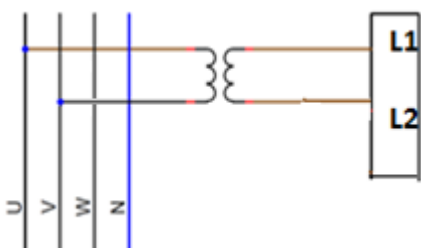

Figure 2: Grid voltage sensing connection

Voltage transformers are mandatory if the grid voltage measurement is higher than 480Vac rms phase-to-phase (686Vac rms maximum for 10 seconds).

Connection	Electrical schematic
Phase/Phase	

D550

Digital Voltage Regulator

- **Temperature measurement inputs**

Each of the inputs can be configured as:

- **PT100**
- **CTP Alternator with 1 temperature sensor**
- **CTP Alternator with 3 temperature sensors in series**
- **CTP User (configurable)**

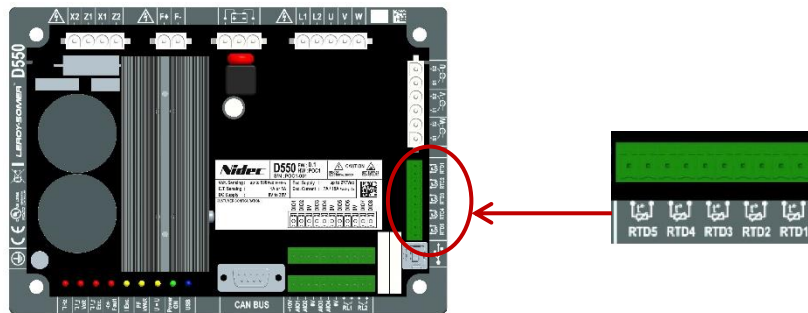

Figure 3: Temperature sensor connections

PT100:

Only 2-wire Pt100 temperature sensors can be connected. If using 3- or 4-wire temperature sensors, the compensation wires must be connected to their equivalent measurement wires:

Connection	Electrical schematic
Without compensation	

The measurement range for these temperature sensor inputs is between -50°C and 250°C . For each connected sensor, two thresholds can be defined: the alarm threshold and the trip threshold.

CTP:

Only 2-wire resistance temperature sensors can be connected.

The measurement range for these inputs is between 130Ω and 4700Ω . A single threshold - the trip threshold - can be defined for each connected sensor.

CAUTION: The temperature inputs are non-isolated and referenced to the product the ground.

D550

Digital Voltage Regulator

- **Inputs/outputs and relay:**

- 4 configurable analog inputs or outputs
- 8 configurable digital inputs or outputs
- 2 relay outputs with normally open volt-free contacts

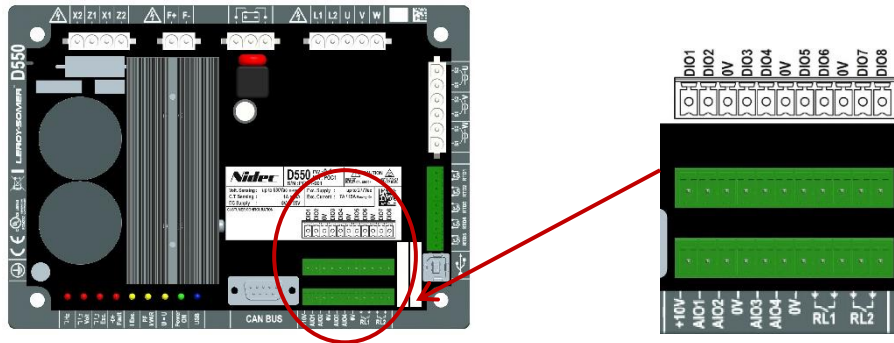

Figure 4: Inputs/outputs connection

- **Analog inputs mode:**

Each analog input can be configured with several modes:

Connection	Electrical schematic
Potentiometer	
4-20mA +/-10V 0/+10V	

Each input is defined by a destination parameter and its signal type (potentiometer, 4-20mA, $\pm 10V$, 0/10V) and by its minimum and maximum limits. The 10V is only present on the terminal block to give a voltage reference or when using potentiometers with values higher than $1k\Omega$ configured in 0-10V mode with a 3-wire connection.

CAUTION: The analog inputs are non-isolated. The 0V is referenced to the product earth.

D550

Digital Voltage Regulator

- **Analog outputs mode:**

Each analog output can be configured with several modes:

Connection	Electrical schematic
4-20mA +/-10V 0/+10V	

Each output is defined by a source parameter and its signal type (4-20mA, $\pm 10V$, 0/10V) and by its minimum and maximum limits.

CAUTION: The analog outputs are non-isolated. The 0V is referenced to the product earth.

- **Digital outputs:**

Each digital output has a MOSFET transistor with open drain. They can each support a maximum voltage of 30Vdc and a maximum current of 150mA.

Connection	Electrical schematic
Digital output	

They are configured by a source parameter (alarm, regulation mode in progress, etc.) and their activation mode: normally open (active low) or normally closed (active high).

CAUTION: The digital outputs are non-isolated. The 0V is referenced to the product earth. Watch out for the risk of reversed polarity on the voltage which could cause the output to break.

- **Digital inputs:**

Each digital input should be controlled by a volt-free contact.

Connection	Electrical schematic
Digital input	

They are configured by a destination parameter (control of a regulation mode, starting, etc.) and their activation mode: normally open (active low) or normally closed (active high).

CAUTION: The digital inputs are non-isolated. The 0V is referenced to the product earth.

D550

Digital Voltage Regulator

- Relay outputs:

The relay outputs are volt-free contacts, isolated from the product earth. They can withstand a maximum voltage of 125Vac-5A or 30Vdc-3A maximum.

The maximum transient load power of the relay is 90W/1290VA.

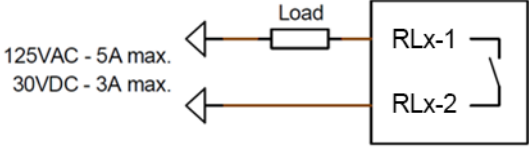
Connection	Electrical schematic
Relay output	 <p>125VAC - 5A max. 30VDC - 3A max.</p>

They are configured by a source parameter (alarm, regulation mode in progress, etc.) and their activation mode: normally open (active low) or normally closed (active high).

- Auxiliary power supply in DC voltage:

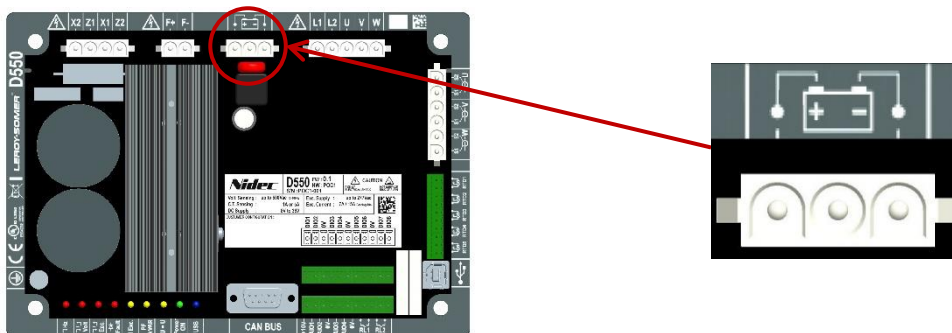

The auxiliary power supply is used to produce the voltages needed for the AVR measurement, control and monitoring circuits. The permitted voltage range is 8Vdc to 35Vdc. The recommended supply voltages are 12Vdc to 14Vdc or 24Vdc to 28 Vdc.

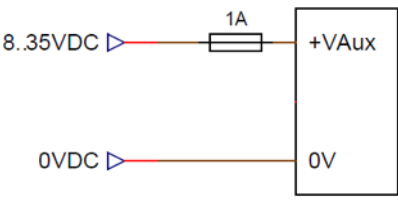
Connection	Electrical schematic
Auxiliary power supply	 <p>8..35VDC</p> <p>1A</p> <p>+VAux</p> <p>0VDC</p> <p>0V</p>

D550

Digital Voltage Regulator

- AC Power supply:

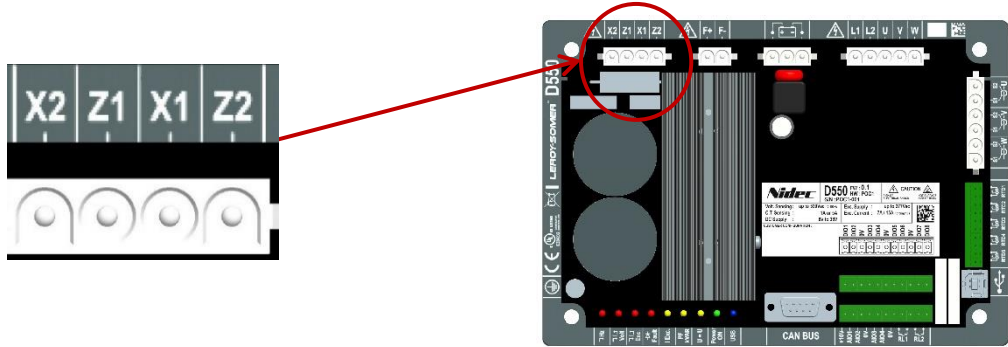

The D550 power stage can take several different source types: SHUNT, PMG, AREP, or external power supply. This stage consists of rectifier diodes as in the electrical schematic below.

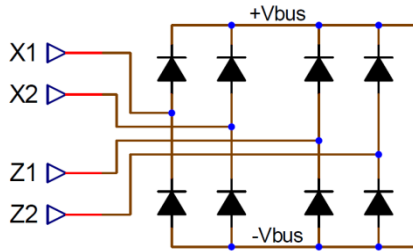

Note: According power supply, a suitable capacitor preloading system will be implemented to avoid damaging them. Total capacitor value: 940 µF. Maximum preloading current: 2 A

The maximum power supply voltage is 300 Vac between each of the connection points X1, X2, Z1, Z2. For applications in the USA, this power input must be protected by class CC fuses (15 A max.) or an inverse time circuit-breaker (10 A max.).

Connection	Electrical schematic
AREP	
PMG	
Phase/neutral SHUNT (low voltage)	

D550

Digital Voltage Regulator

- Exciter Field:

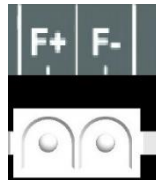

Connection	Electrical schematic
Exciter Field : F+ F-	

- Alternator current measurement (parallel operation CT):

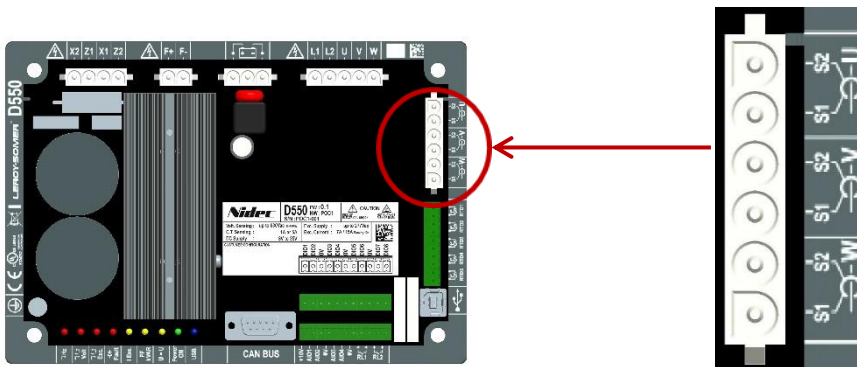

The alternator current can be measured on 1 phase or 3 phases. When mounting a single CT, it can be mounted on phase U or phase V.

Connection	Electrical schematic
With one CT per phase	
With only one CT	

D550

Digital Voltage Regulator

- **Alternator current measurement for the “cross current compensation” function:**

For cross current compensation, the measurement inputs from the parallel operation CT (if connected) and the cross current CT are fixed:

- The parallel operation CT must be mounted on phase U.
- The cross current CT must be mounted on phase V.

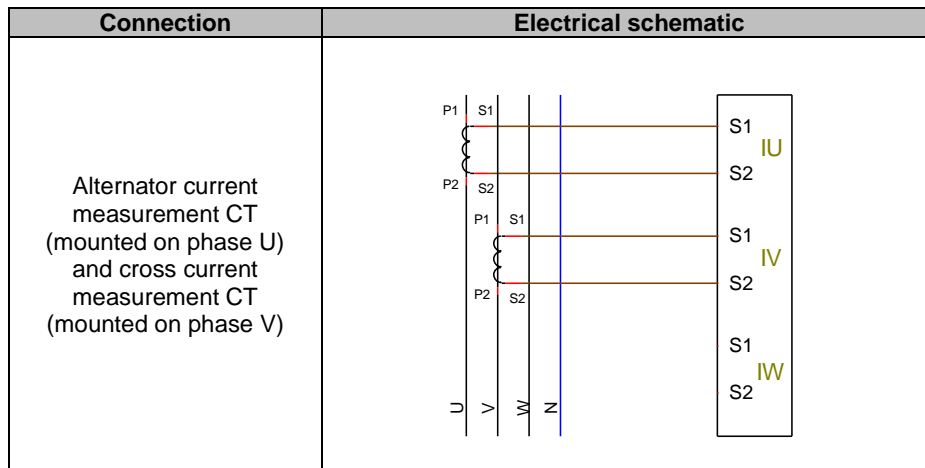

The loop wiring between the alternators must respect the diagram below (example for x alternators equipped with D550).⁴⁵⁶

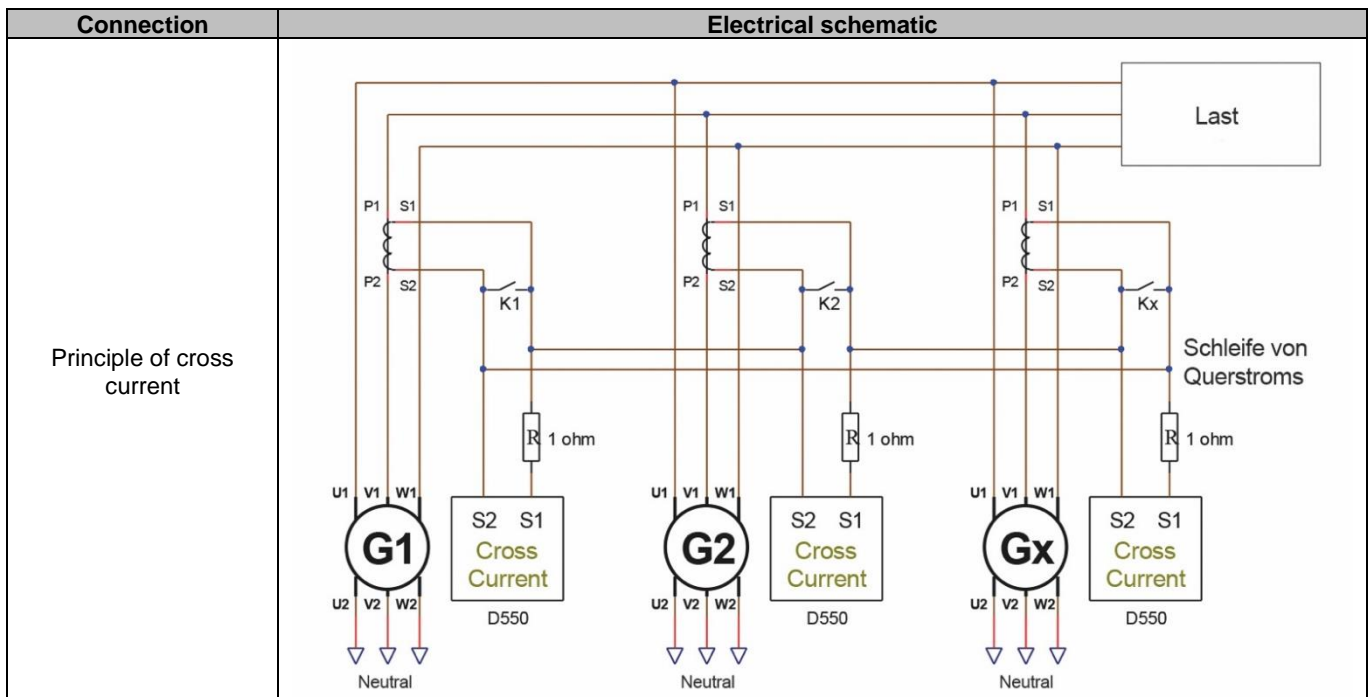

⁴ If the machine is not operating, contact K must be closed. It must be open if the machine is operating.

⁵ The differential current loop does not allow power ratings to be calculated on the D550. If this kind of measurement is essential for the application to operate correctly, an additional CT must be connected to the alternator current measurement input.

⁶ 1 ohm resistors must be connected to the cross current input on each AVR.

D550

Digital Voltage Regulator

- **Grid current measurement for “power factor regulation at the delivery point” or “grid code”:**

For power factor regulation at the delivery point, or for grid code, the measurement inputs from the parallel operation CT and the grid current measurement CT are fixed:

- The parallel operation CT must be mounted on phase U.
- The grid current measurement CT must be mounted on phase V.

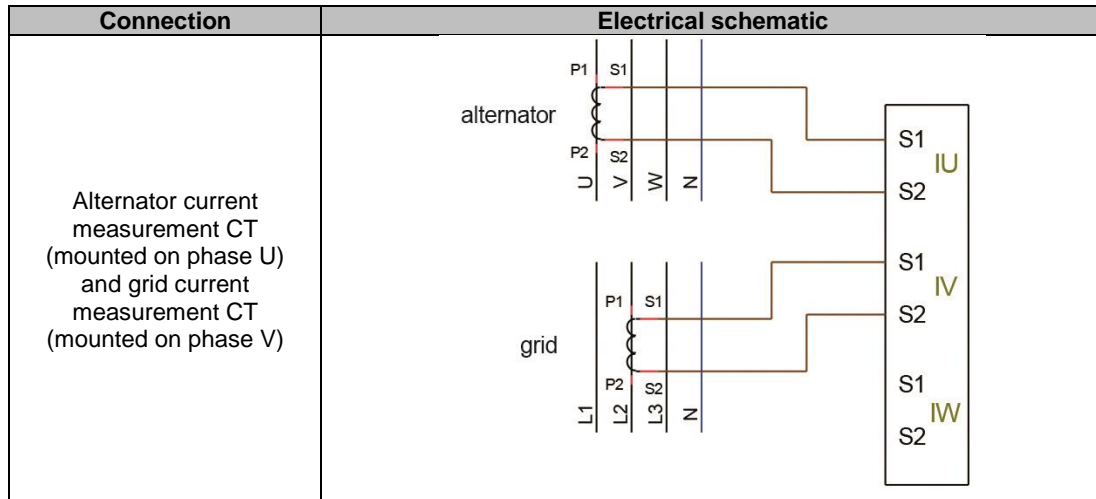

Note: If the CTs are not installed on the phases indicated, it will be possible to change the phase angle in the configuration.

2.4. Wiring precautions

Cables must never exceed 100 m in length.

To ensure respect of standards IEC 61000-6-2, IEC 61000-6-4, IEC 60255-26, shielded cables are imperative in case of a D550 installed outside of the terminal box.

The total ohmic value of the exciter loop (out and back) must not exceed 5% of the exciter resistance, regardless of the cable length.

The total ohmic value of the power system cables must not exceed 5% of the exciter resistance, regardless of the cable length.

For information, the resistance at 20°C in mΩ/m for copper cables is approximately:

Cross-section (mm ²)	Resistance (mΩ/m)
1.5	13.3
2.5	7.98
4	4.95
6	3.3
10	1.91

Calculation example:

For a 10Ω exciter

- Maximum cable resistance = 0.5Ω (2 x 0.25Ω)
- Cross-section as a function of the distance between the AVR and the alternator:

Distance (m)	Cross-section (mm ²)
30	2.5
50	4
75	6
100	10

D550

Digital Voltage Regulator

3. Description of operating running modes

3.1. Regulation modes

The various regulation modes to be configured depend on the alternator operation (standalone, parallel between machines, parallel with the grid). Based on these different operating modes, certain regulation modes will need to be enabled (some of which are strongly recommended, or even mandatory, and others optional).⁷ The simplest examples are shown below:

- **Example no. 1: The alternator is only connected to a load (factory, lighting, pump, etc.)**

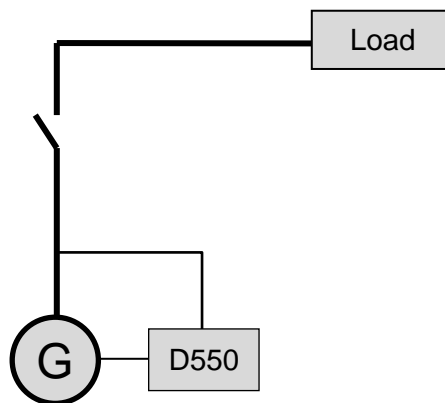

- **The AVR is operating in voltage regulation mode only.**
- There is no need to measure the alternator current. In this example, no power rating can be indicated, and the stator current limit cannot be enabled, nor load compensation nor quadrature droop.
- **Field current regulation is optional.** In this case, the reference must be permanently set so that it matches the existing load and will not risk any damage to the load or the machine (risk of overvoltage or under voltage and risk of over excitation).

⁷ The following schematics are given for information only, they do not take into account any step-up transformers or voltage sensing transformers. The presence of a transformer for measuring the alternator current is however indicated depending on the regulation mode.

D550

Digital Voltage Regulator

- **Example no. 2: The alternator is connected to other alternators and a load (factory, lighting, pump, etc.).**

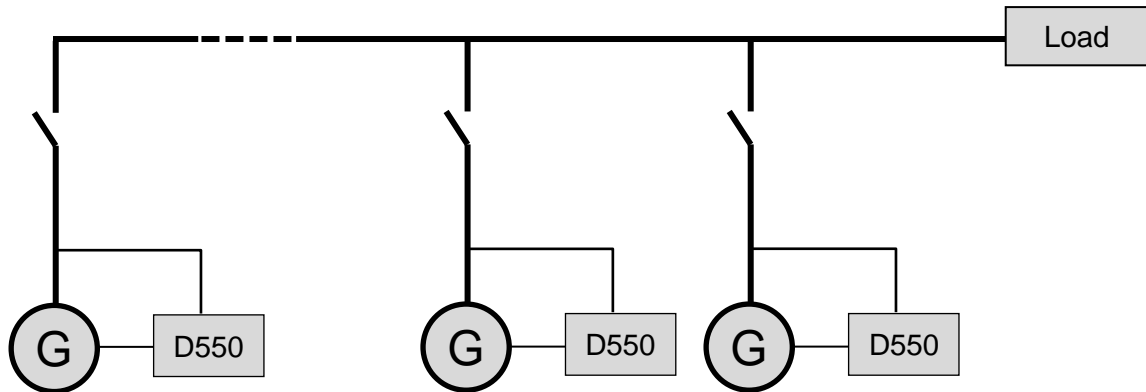

- **The AVR is operating in voltage regulation mode only.**
- In order to divide the load reactive power equally between all the machines which are running, select one of the two following modes:
 - Quadrature droop: voltage drop according to the percentage of rated reactive load applied to the machine. In this case, alternator current measurement is mandatory on the alternator current measurement input.
 - Cross current: reactive load sharing from a current loop. In this case, a dedicated CT needs to be connected and a current loop needs to be created on the “Cross current” input. Consult technical support for more information.
- Note: Load compensation cannot be enabled if quadrature droop or cross current is active.
- **Field current regulation is optional.** In this case, the reference must be permanently set so that it matches the existing load and will not risk damaging the load or the machine (risk of overvoltage or under voltage and over excitation).

D550

Digital Voltage Regulator

- **Example no. 3: The alternator is in parallel with the grid⁸**

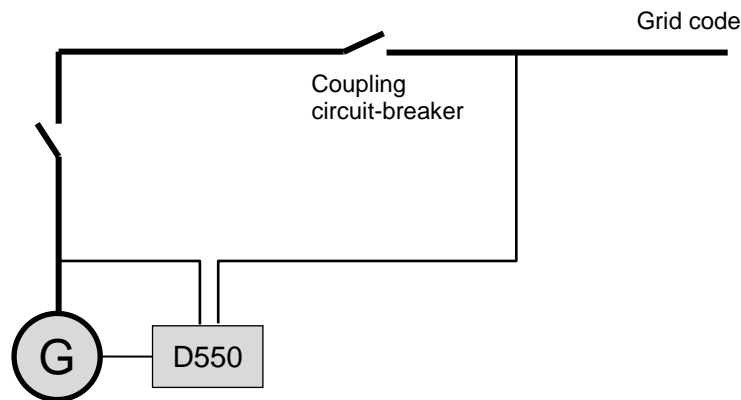

- **The AVR is operating in voltage regulation mode when the alternator starts.** Quadrature droop or cross-current correction is not needed only if the alternator is connected to the grid.
- **The voltage match circuit is used to adjust the alternator voltage to the grid voltage prior to connection.** This can be done automatically by directly measuring the voltage after the coupling circuit breaker, or by changing the alternator reference.
- **Regulation of the alternator power factor, kVAr, or power factor at one point of the grid must be enabled once the coupling circuit breaker is closed.**
 - Alternator current measurement is essential in all these regulation scenarios.
 - Regulation of the power factor at one point of the grid also requires alternator voltage and current measurements, measurement of the grid voltage and current at the required point (in this case, the power factor is calculated by the D550).
- **Field current regulation is optional.** In this case, the reference must be permanently set so that it matches the existing load and will not risk damaging the load or the machine.

Note: Different regulation types have priority. The order is as follows (highest priority down to lowest priority):

- **Field current**
- **If the grid code connection contactor is closed:**
 - **Grid power factor**
 - **Alternator kVAr**
 - **Alternator power factor**
- **Voltage matching circuit**
- **Voltage**

See [appendix 8.2](#) for AVR regulation .

Note: Switching from one regulation mode to another is bumpless.

⁸ A grid is deemed to be any electricity supply whose power rating is at least ten times higher than the alternator rated power.

D550

Digital Voltage Regulator

3.2. Control of modes and information

Switching from one regulation mode to another, transferring operating modes, and monitoring of alarms or trips can be done by several means: inputs and outputs or communication.

Also, see the schematic for the alternator on which your AVR is installed.

3.3. Protection functions

The D550 integrates certain protection devices:

- Under voltage (Code ANSI 27);
- Open diode and diode short-circuited failures
- Overvoltage (Code ANSI 59);
- Under frequency (Code ANSI 81L);
- Over frequency (Code ANSI 81H);
- Active reverse power (Code ANSI 32P);
- Reactive reverse power (Code ANSI 32Q);
- Synchro check (Code ANSI 25).

3.4. Related functions

Other D550 functions can be used to record events, supervise the phase synchronizing the alternator with the grid, or create simple control systems or functions for monitoring references. The D550 also integrates dedicated functions for grid operators (Grid Code functions).

4. Communication

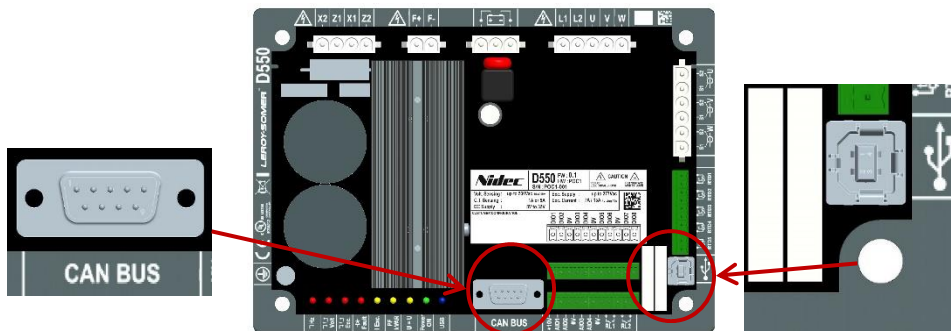

4.1. USB

- For “USB” communication, use the dedicated cable with connector USB “A” on computer side, and USB “B” connector on AVR side
- If a D550 is connected, it must appear on the bottom left of the PC software EasyReg Advanced:

D550 CONNECTE

D550

Digital Voltage Regulator

4.2. CAN

Activate CAN bus function

Define D550 address in J1939 protocol

Enable J1939 periodic frame generation

Add a delay between product startup and CAN bus startup

CAN configuration

Enable CAN

Data transfer Rate: 1000 Kb (L <= 30m)

D550 Address: 144

CAN Enable proprietary broadcast

Enable J1939 broadcasts/requests

SUB-D9 Power supply enable

Boot delay of CAN module (ms): 0

Define CAN bus speed (Speed define in Kbits/s)

Enable proprietary periodic frame generation

Enable power supply on CAN bus connector (use for EasyLog/EasyLogPS product)

More detail about the frame generate and received by this product are available in D550 CAN bus documentation reference 5806.

4.3. LED

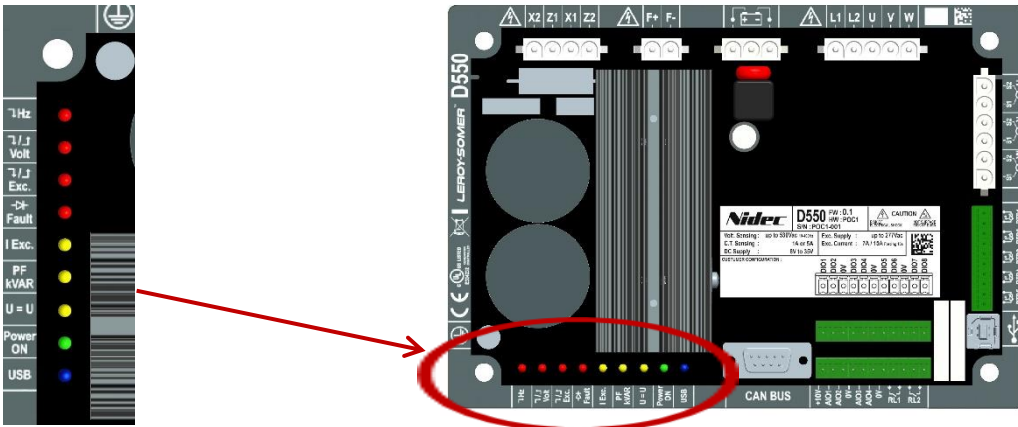

Silkscreen printing	Color	Signification	
(Under) Hz	RED	Frequency Fault	ON = Underspeed operation
(Under/Over) Volt	RED	Voltage Fault	ON = Under or Over Voltage
(Under/Over) Exc.	RED	Excitation Fault	ON = Rotor overheating
			BLINK = Rotor Overload or Under Excitation or Minimum excitation
Fault (diode)	RED	Diode Fault	ON = Diode Open or in short circuit
I Exc.	YELLOW	Iexc regulation	ON = Manual excitation mode
PF / kVAR	YELLOW	PF or kVAR Regulation	ON = PV or kVAR regulation mode
U=U	YELLOW	Voltage equalization	ON = Voltage equalization mode
Power ON	GREEN	Power ON	ON = Regulation in operation
			BLINK = Product Energized
USB	BLUE	USB OK	ON = USB connected

D550

Digital Voltage Regulator

5. Setting instructions

5.1. PC Software

All the D550 settings can be entered using the “EasyReg Advanced” software supplied with the AVR. The parameter-setting pages describe primarily the alternator parameters, regulations, limits, and protection devices.

5.1.1. Software Installation

EasyReg Advanced® is the software to be used for configuring the regulator.

Note: This program is only compatible with computers running WINDOWS® versions Windows 7 and Windows 10 operating systems.

Execute this program, checking first that you have “Administrator” rights for your terminal.

Step 1: Choose the installation language

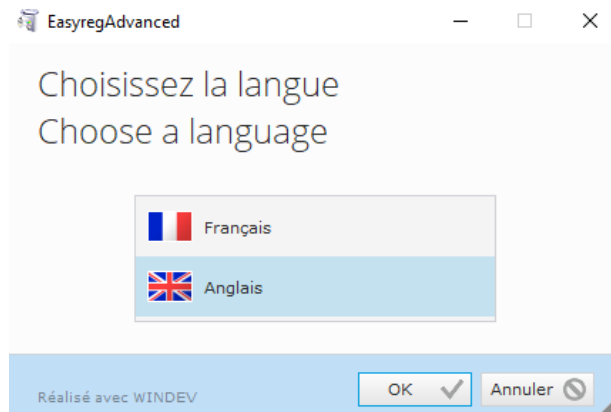

Step 2: Choose the installation type:

- Quick installation: the files are copied automatically and the software directory is created
- Custom installation:
 - Choose the installation directory

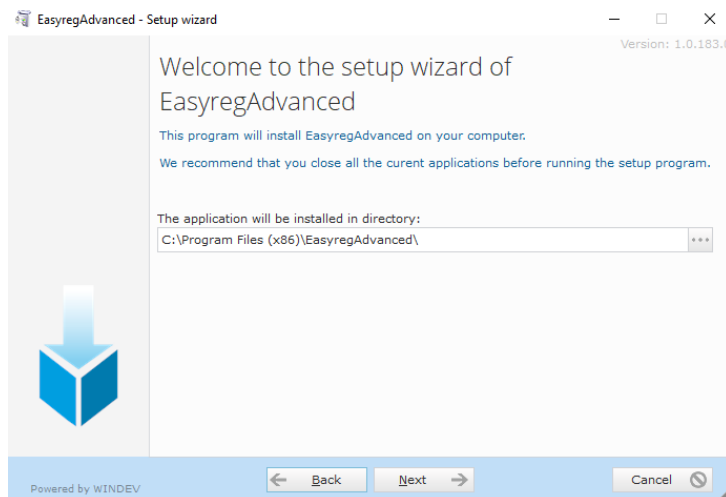

D550

Digital Voltage Regulator

- After selecting the directory, click “Next”
- Confirm by clicking “Install” if the path is as expected

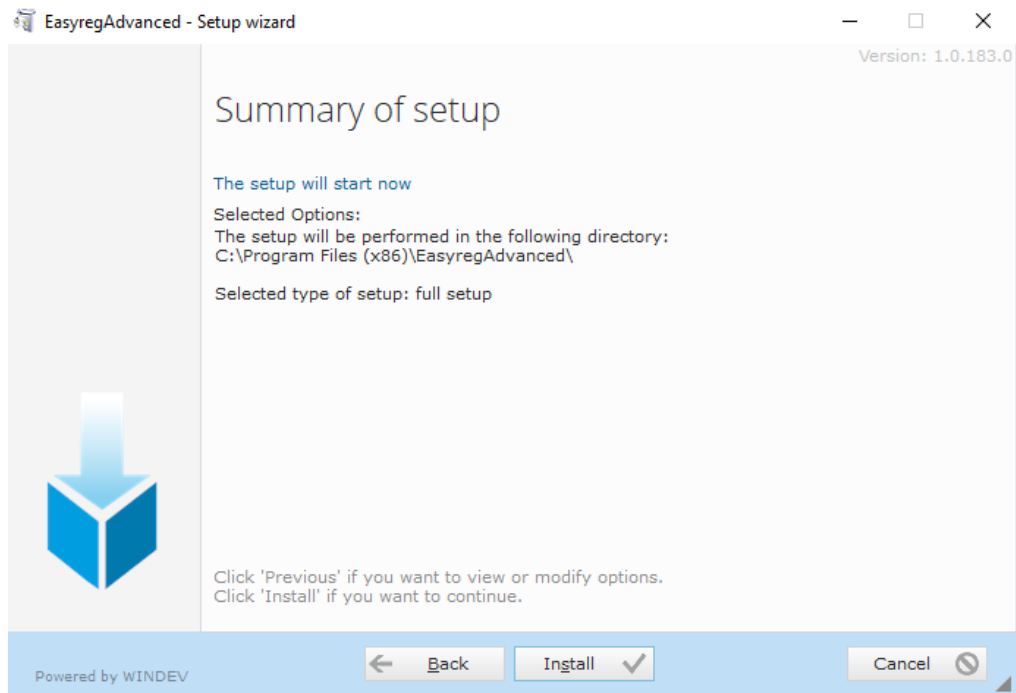

Step 3: Once installation is complete, you can choose to start the software (box ticked by default) and to manage the shortcuts. Click on “Done” to quit the installation page.

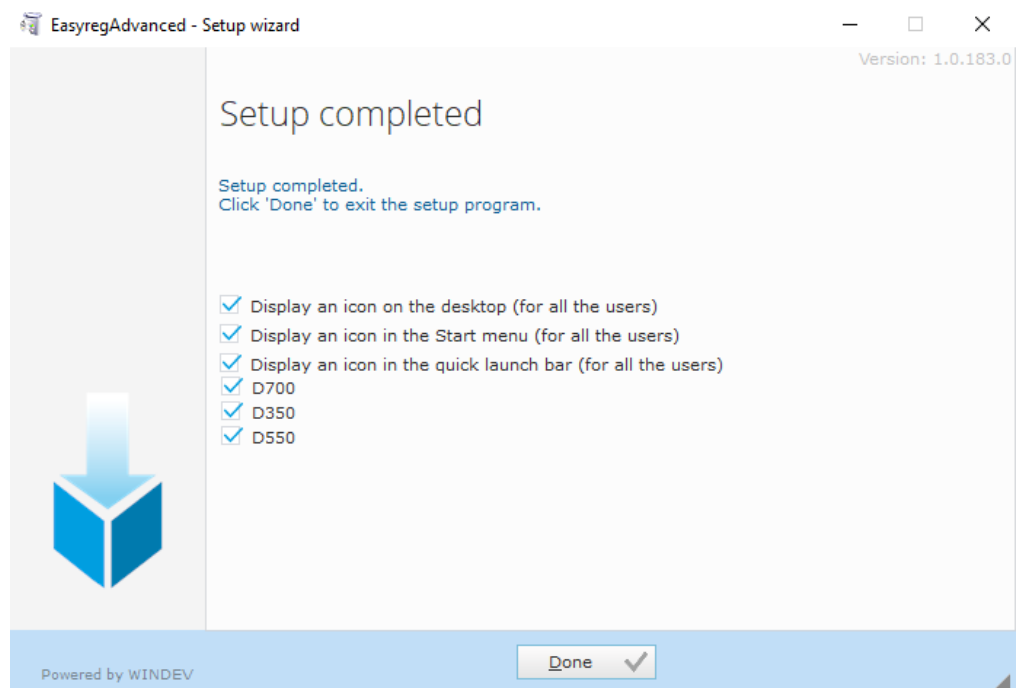

A shortcut is created on your desktop:

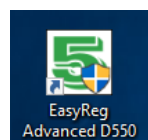

D550

Digital Voltage Regulator

5.1.2. Different access levels of Easyreg Advanced

Two modes are available:

- **User (standard)**: for read only access to the parameters.

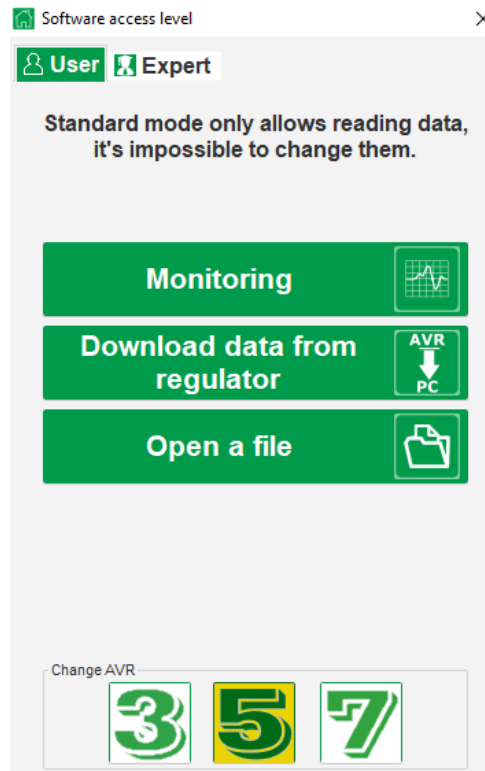

- **Expert**: for full access to the different functions of the regulator in read and write modes.

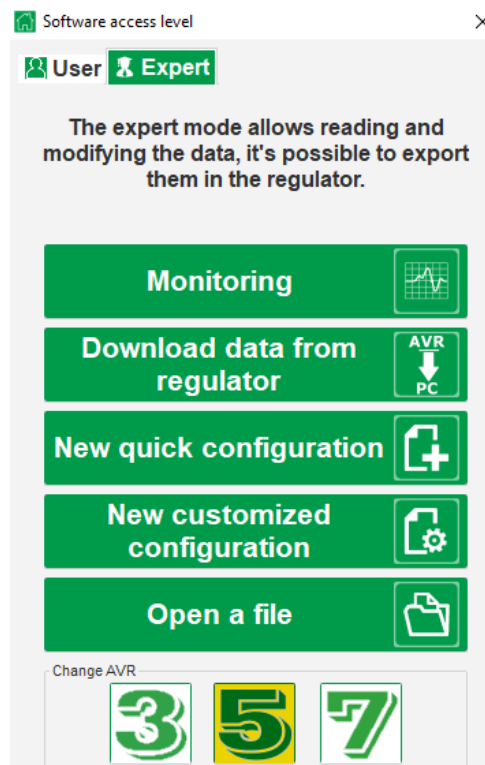

D550

Digital Voltage Regulator

5.1.3. Description of the banner and tabs

The software takes the form of a single window with a general banner and a bottom zone where sub-windows are opened.

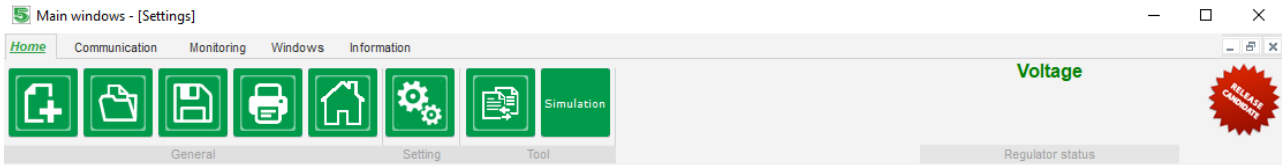

The banner consists of 5 tabs:

- “Home” tab:

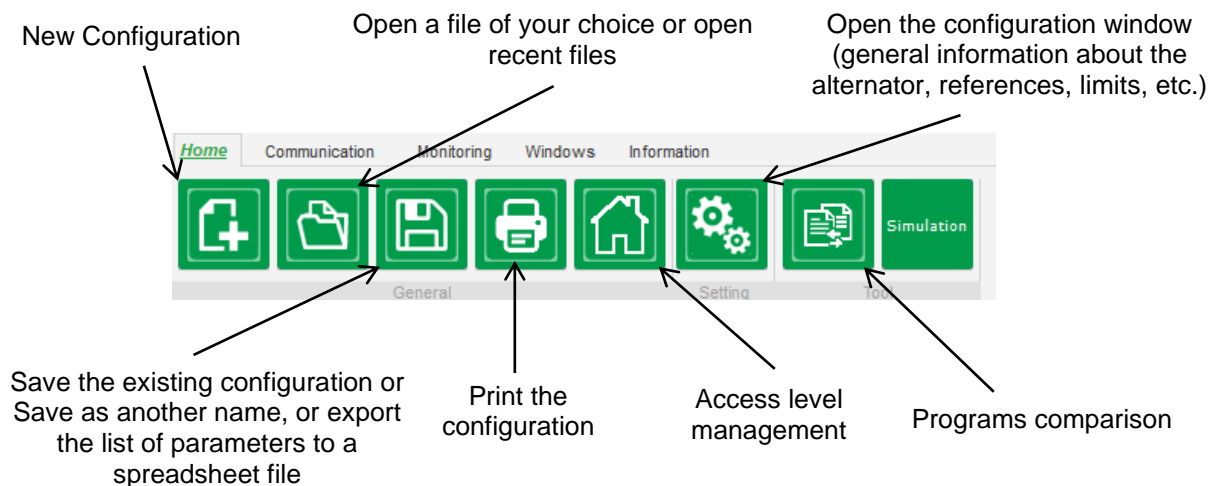

- “Communication” tab:

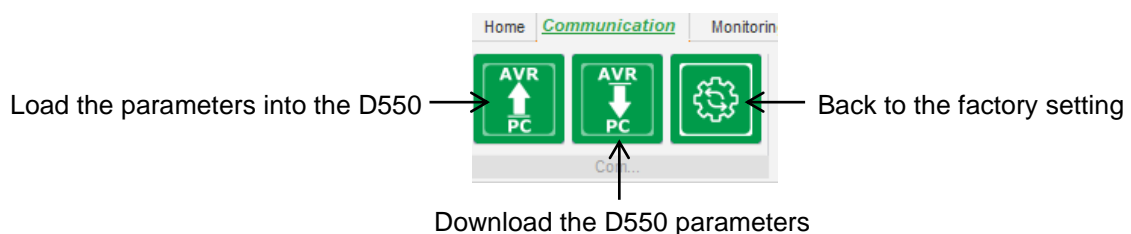

Note: Before parameters are exported the user will be asked to confirm and to check the product status (regulation in progress or not). If regulation is in progress, confirmation is requested again.

D550

Digital Voltage Regulator

- “Monitoring” tab:

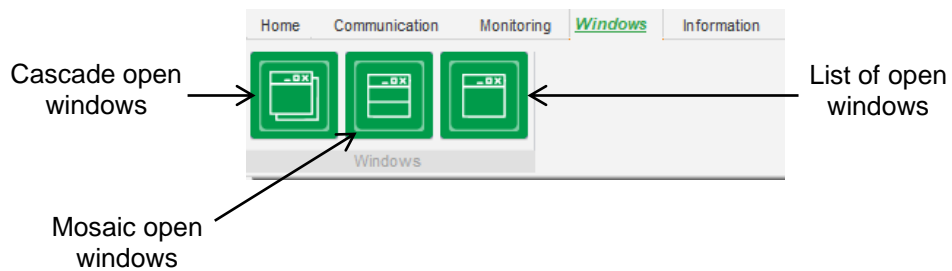
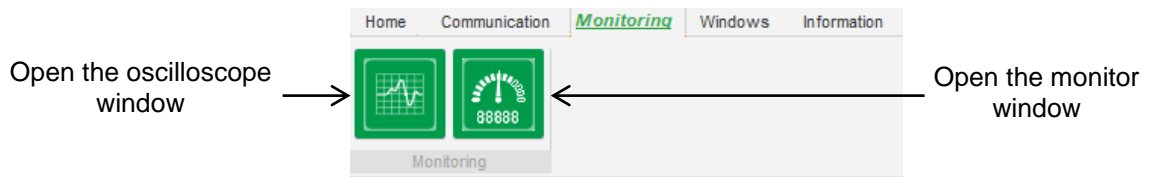

- “Information” tab:

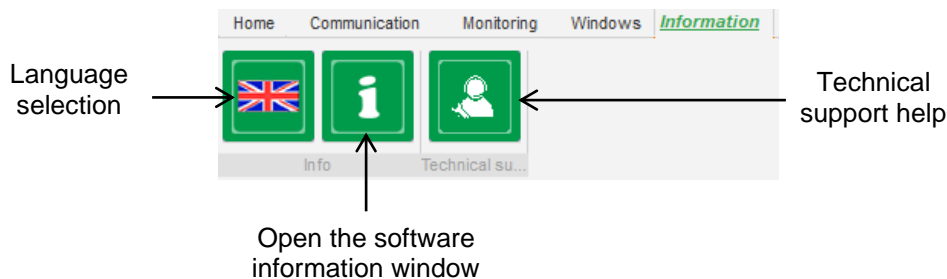

The D550 is equipped with running hours counter accessible in the « About  » window (given in hours and minutes).

Note: This counter is updated every 10min and only when the voltage regulation setpoint is reached.

The firmware update can also be done in this window as shown next.

D550

Digital Voltage Regulator

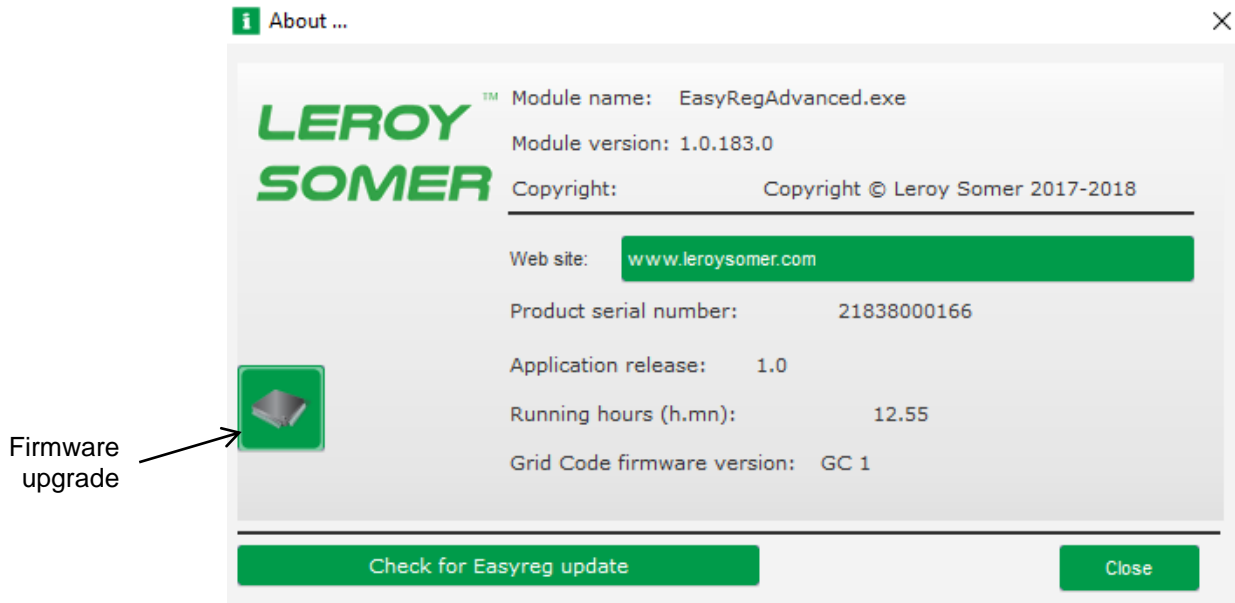

- "Regulator state" window:

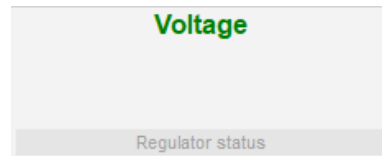

5.1.4. Communication with the D550

Communication between the D550 and the PC software. When the communication is established, a confirmation message is displayed on the bottom left of the PC software as shown below.



5.1.5. Description of the "Configuration" window

This window consists of several pages for configuring the entire alternator operation. To scroll through the pages, use the "Next" or "Previous" buttons or click on the list of pages.

Note: More details of these pages are given in the sections describing how to create a new customized configuration.

D550

Digital Voltage Regulator

Quick configuration:

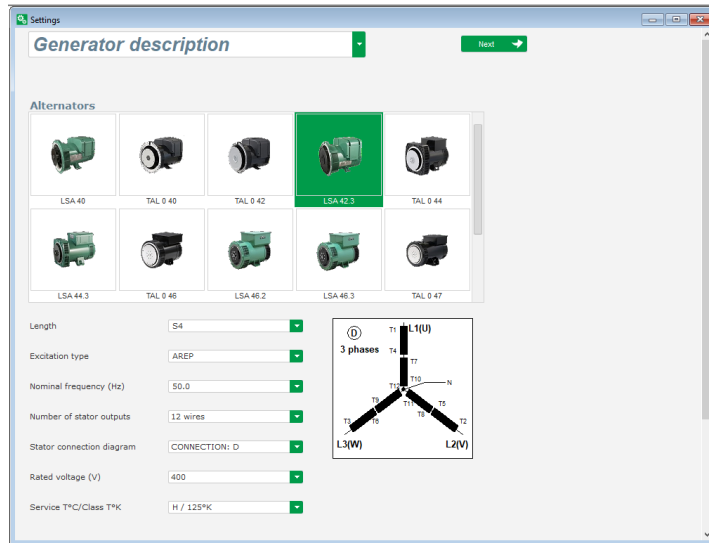

Customized configuration:

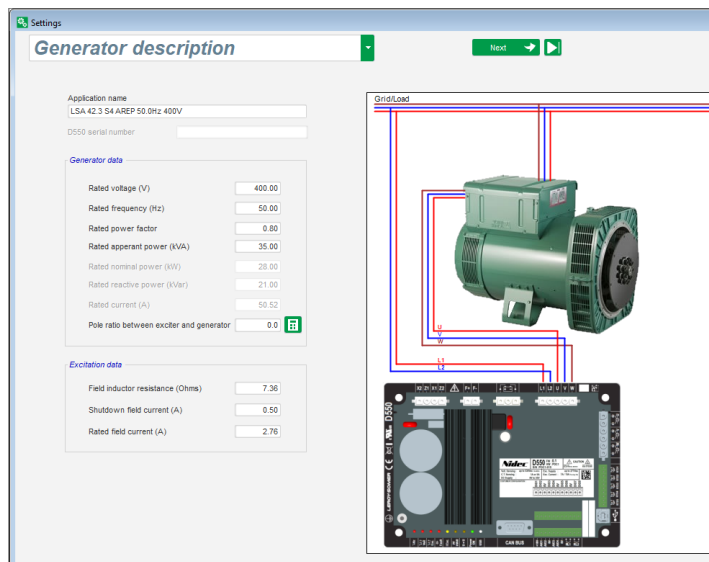

Limits: this page contains the parameter settings for the various machine limits (maximum and minimum field current, stator current limit).

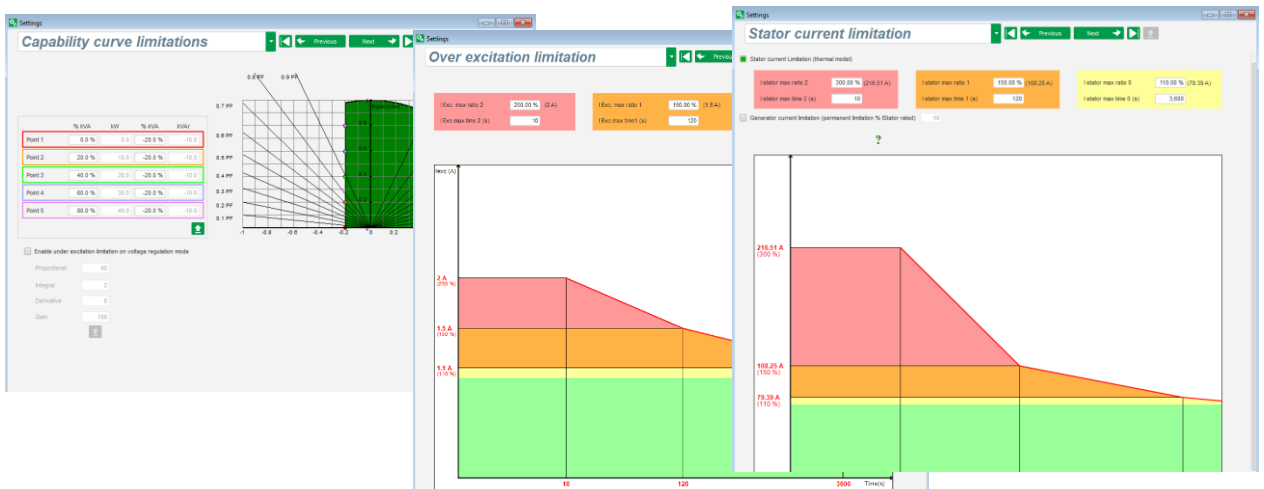

D550

Digital Voltage Regulator

- Protection devices:** this page contains the parameter settings for the protection devices provided by the D550 (rotating diode failure, overvoltage and under voltage, temperatures, etc.).

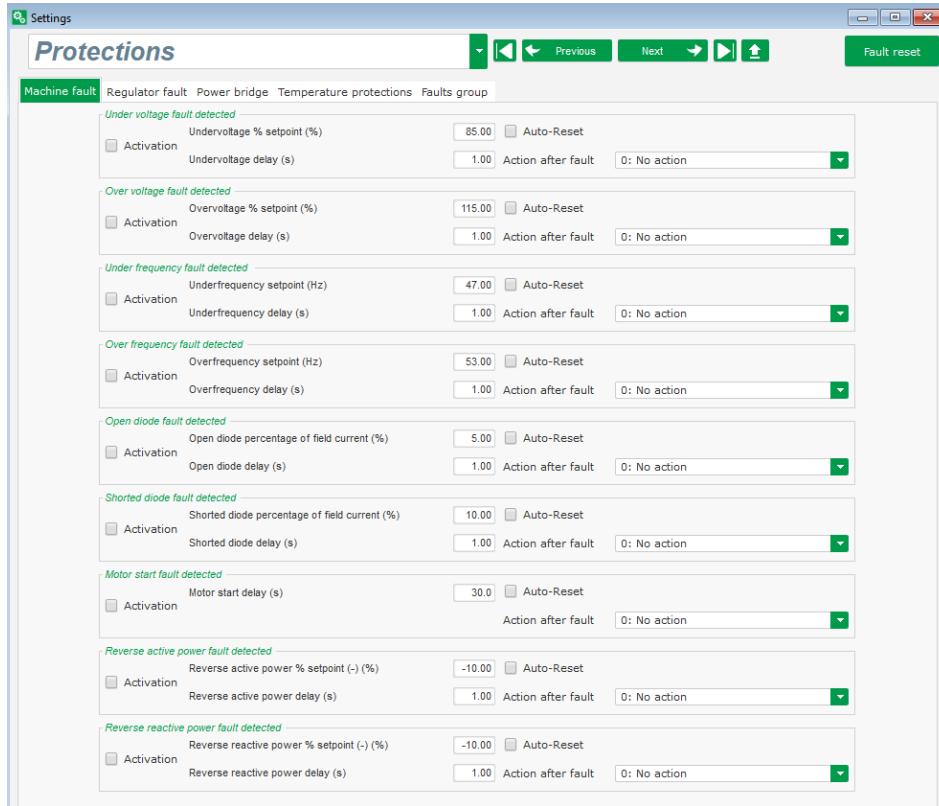

One page allows doing some faults groups or summarize information as “fault synthesis”.

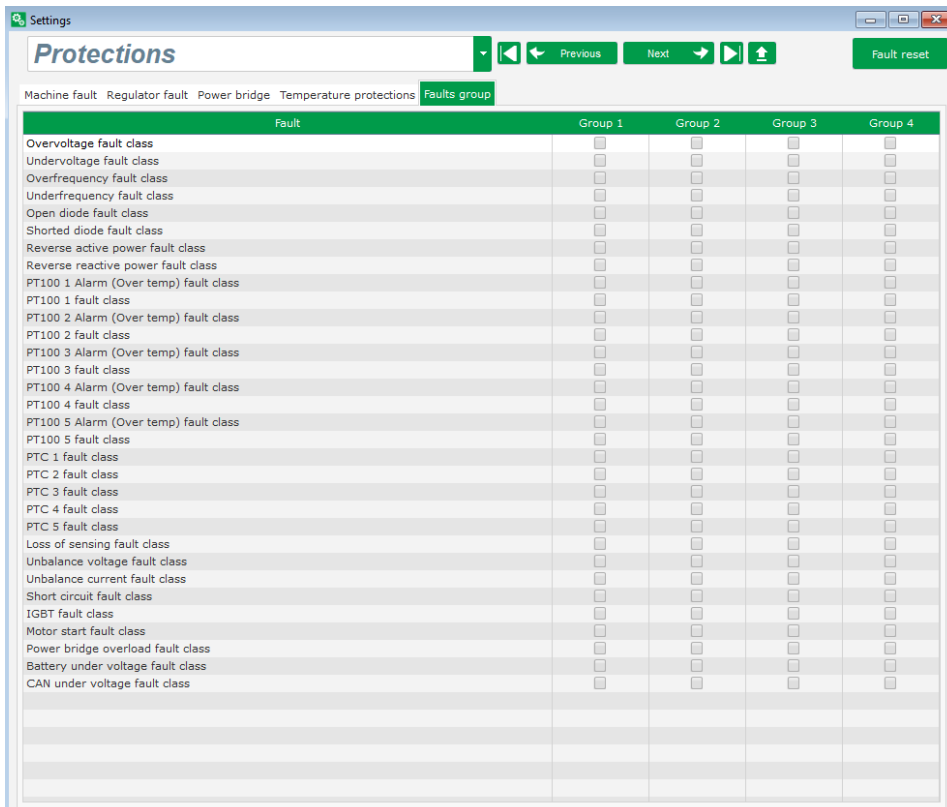

D550

Digital Voltage Regulator

- **I/O:** this page contains an overview of the digital and analog I/O parameter settings.

Digital Inputs

Digital Input	Active	Destination
DI1	Active Low	None
DI2	Active Low	None
DI3	Active Low	None
DI4	Active Low	None
DI5	Active Low	None
DI6	Active Low	None
DI7	Active Low	None
DI8	Active Low	None

Digital Outputs

Source	Active	Digital Output
None	Active Low	DO1
None	Active Low	DO2
None	Active Low	DO3
None	Active Low	DO4
None	Active Low	DO5
None	Active Low	DO6
None	Active Low	DO7
None	Active Low	DO8
None	Active Low	RL1
None	Active Low	RL2

Analog Inputs/Outputs

ID	Configuration AI	Destination	0% value	100% value	Configuration AO	Source	0% value	100% value
AIO1	0-10V	None	0.00	0.00	None	None	0	0
AIO2	0-10V	None	0.00	0.00	None	None	0	0
AIO3	0-10V	None	0.00	0.00	None	None	0	0
AIO4	0-10V	None	0.00	0.00	None	None	0	0

Analog inputs hold during Wire break

AIN 1
 AIN 2
 AIN 3
 AIN 4

- **Curve functions:** this page is used to define the control functions of a parameter as a function of another by plotting 5 points.

Curves Functions

X axis: Generator Average Voltage (Ph-Ph) | Y axis: Reactive power setpoint

Point 1: 384.00 | 1,400.00
 Point 2: 389.00 | 0.00
 Point 3: 400.00 | 0.00
 Point 4: 415.00 | 0.00
 Point 5: 420.00 | -1,400.00

Graph: Reactive power setpoint=f(Generator Average Voltage (Ph-Ph))

X axis: None | Y axis: None

Point 1: 0.00 | 0.00
 Point 2: 0.00 | 0.00
 Point 3: 0.00 | 0.00
 Point 4: 0.00 | 0.00
 Point 5: 0.00 | 0.00

Graph: None=f(None)

D550

Digital Voltage Regulator

- **Logic/analog gates:** this page is used to configure simple logic functions at I/O level and the type of gate.

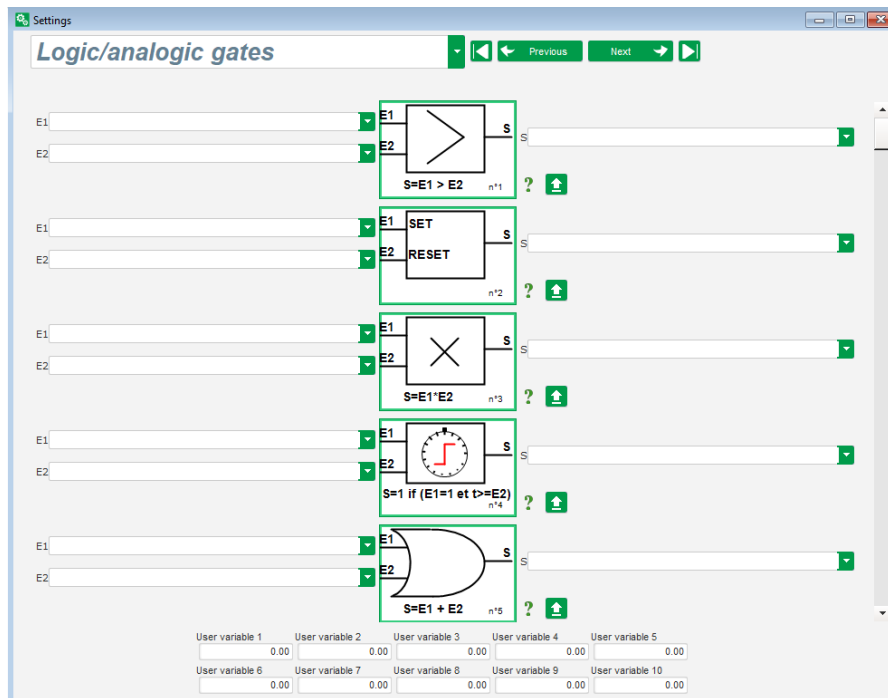

- **Data logger:** this function is available when the optional modules Easy Log or Easy Log PS are connected from the CAN page. It allows to define the parameters and triggers for saving in a log file. The various operating modes for these triggers, the parameter trigger values and the sampling speed can be configured.

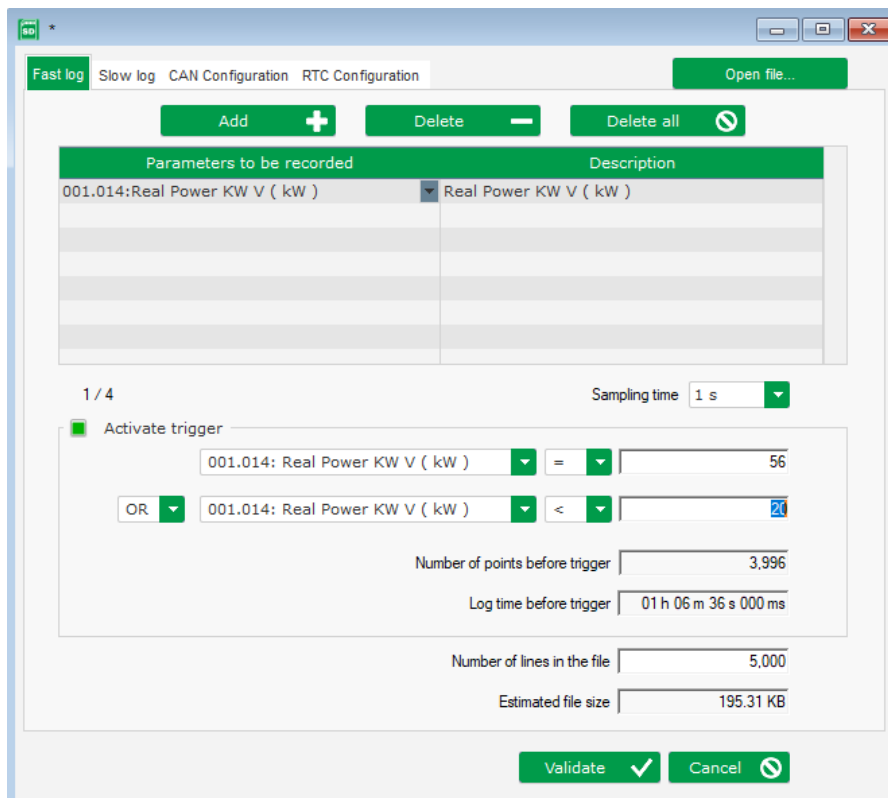

D550

Digital Voltage Regulator

- **Synchronization:** this page is used to define the parameters for synchronization between the alternator and the grid.

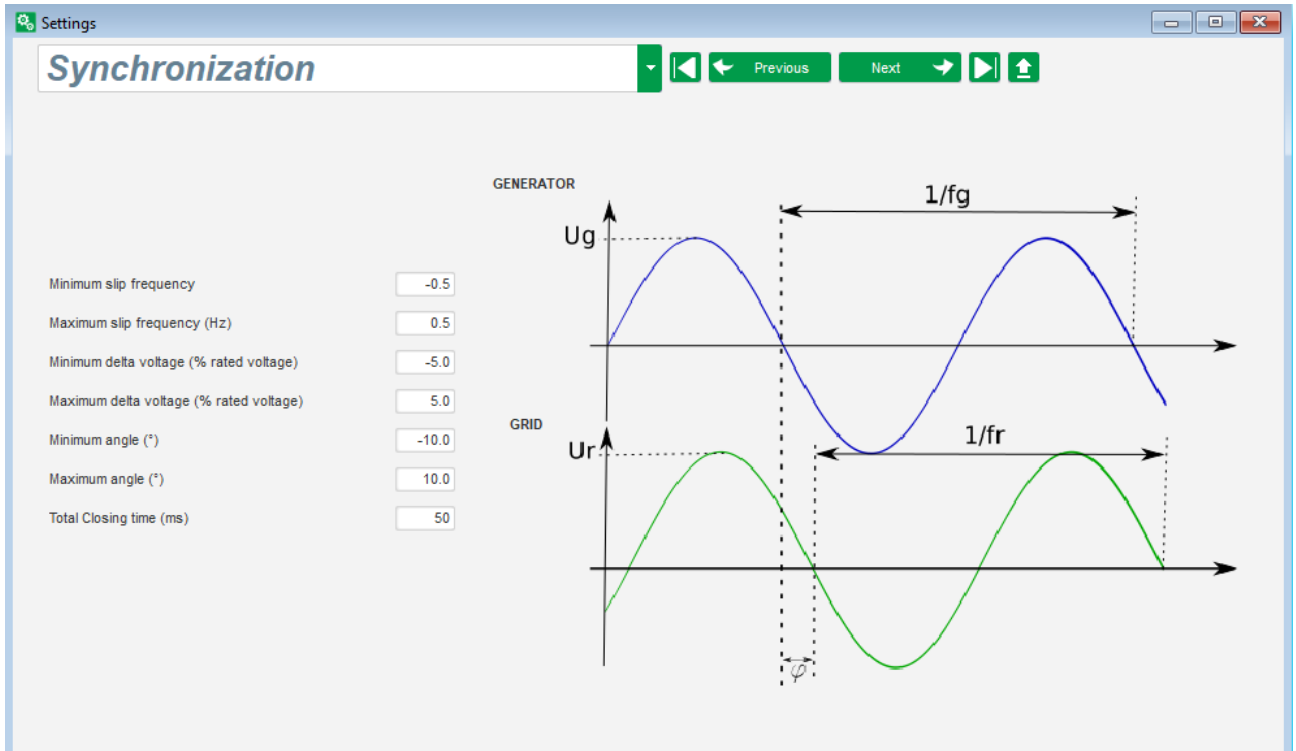

- **Grid code:** This function is available when the optional modules Easy Log or Easy Log PS are connected. This page is used to define the parameters dedicated to grid code protections.

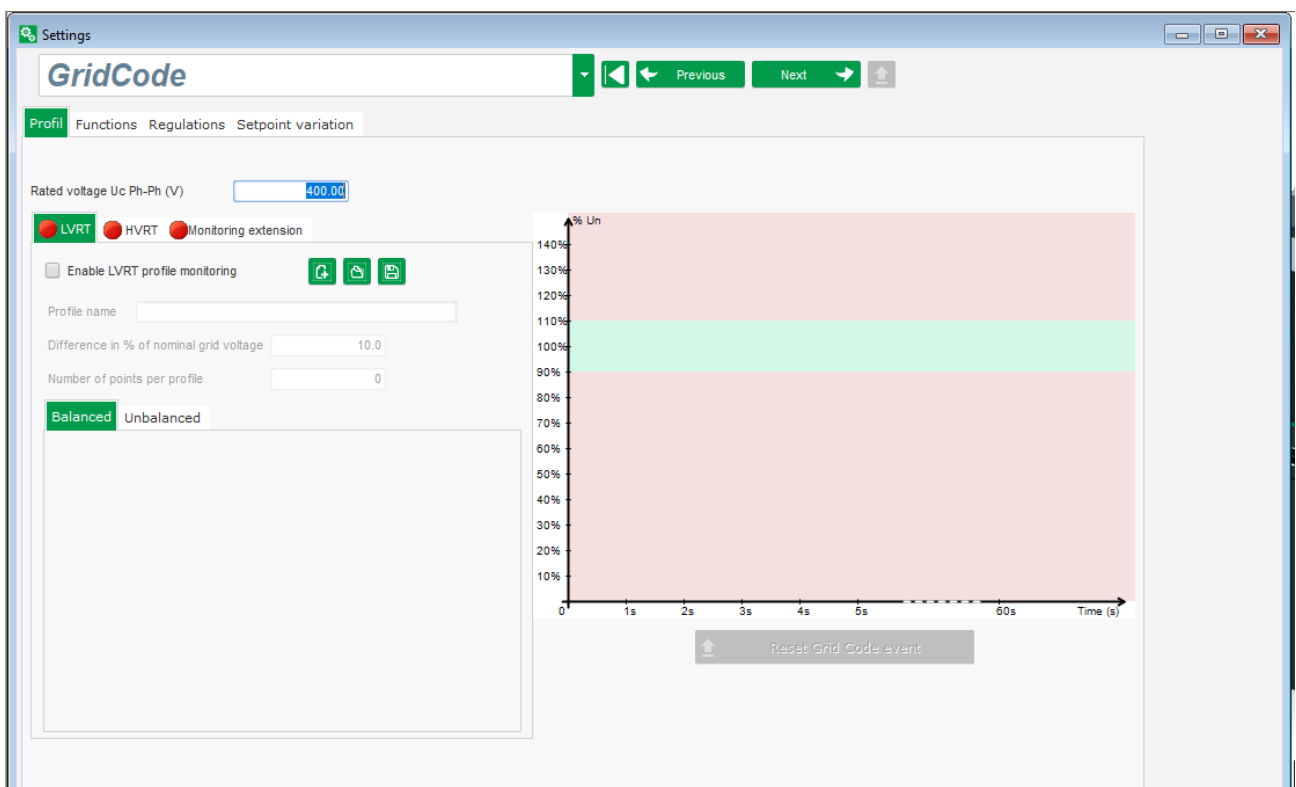

D550

Digital Voltage Regulator

5.1.6. "Oscilloscope" window

This window is used to trace the evolution of the measured values of up to 8 parameters simultaneously.

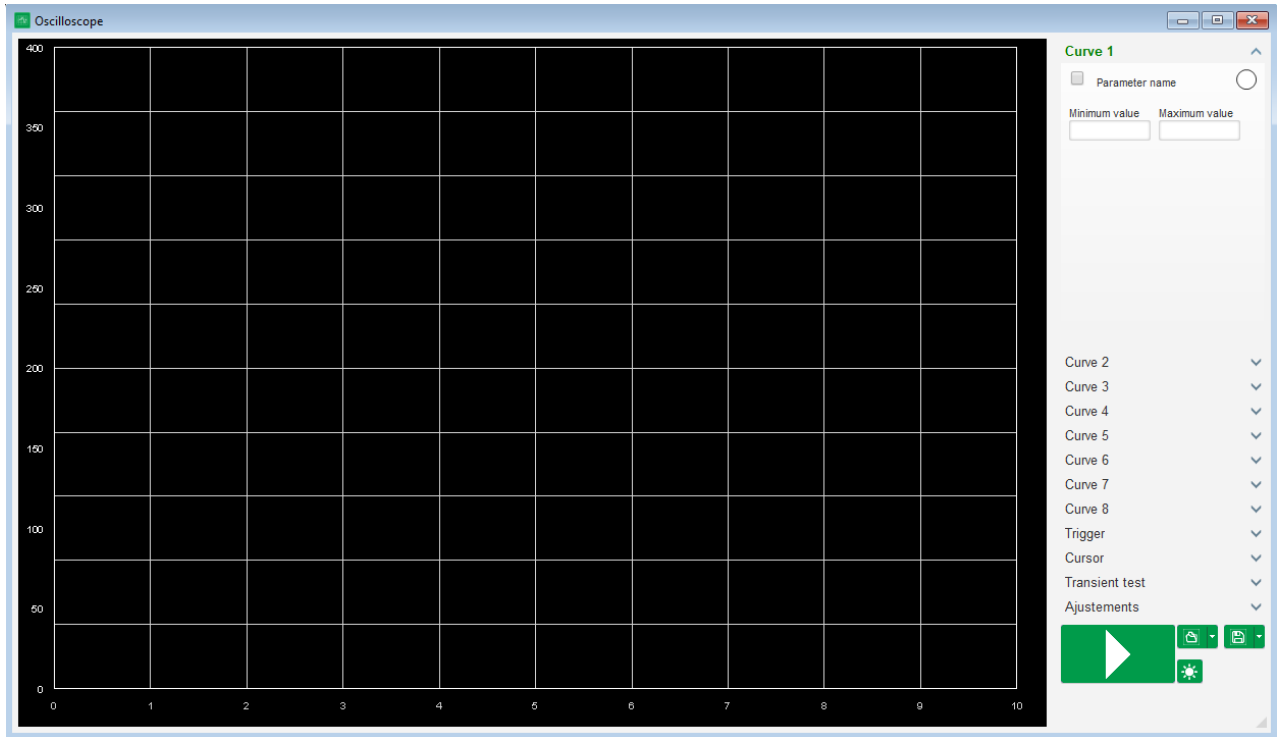

5.1.6.1. Curves

Each curve is described by: its color, its source parameter, its minimum and maximum values. It has its own axis, which is the same color as the curve.

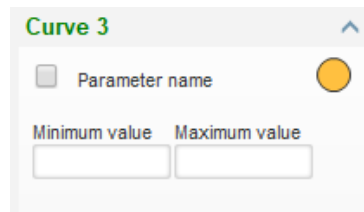

- **To change the color:**
 - Click on the colored disk on the right of the curve name, and a predefined color palette will open.

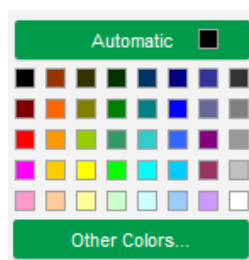

- Click on the new curve color from those available.
- The color selection window is then automatically closed, and the disk then takes on its selected color.

D550

Digital Voltage Regulator

- Should you wish to configure a color not available in the color palette, click on the “Other colors...” button. The palette is then transformed. Move the black cross to the selected color or fill in the text boxes (each value between 0 and 255) to define the RGB color values. Then click “OK”.



NB: When you no longer wish to change the color, just click outside the palette. It will be closed automatically.

- Select a parameter to plot**
 - Click on the tick box.
 - If the box was already selected, a confirmation message appears. By clicking on, “Yes”, a window opens with the list of parameters.

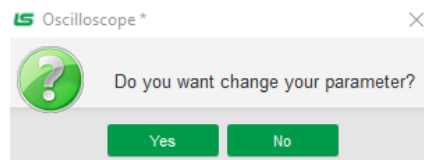

- If the box was not already selected, the window with the list of parameters opens directly.
- Select the parameter you wish to track from the drop-down list. This parameter can be an analog or digital value (regulation mode for example).
- Click “OK” to use the selected parameter, or “Cancel” if you don’t wish to change anything.

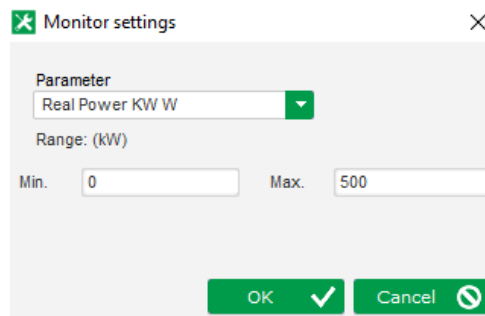

- Refine the plotting range:** change the minimum and maximum values if necessary. These values are taken into account and the trace is re-scaled as soon as one of the boxes is exited or the keypad “Enter” key is pressed.

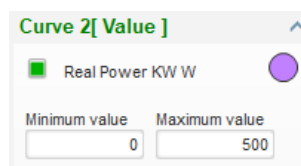

When the monitor is on, the current value appears in square brackets.

D550

Digital Voltage Regulator

5.1.6.2. Trigger

The trigger is used to launch oscilloscope operation once the chosen parameter value exceeds the value entered either upwards (arrow facing up) or downwards (arrow facing down).

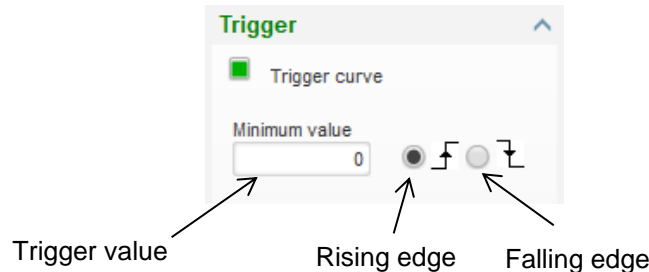

- **Select whichever of the curves caused the trip**
 - Click on the tick box.
 - If the box was already selected, a confirmation message appears. By clicking on “Yes”, a window opens with the list of parameters.

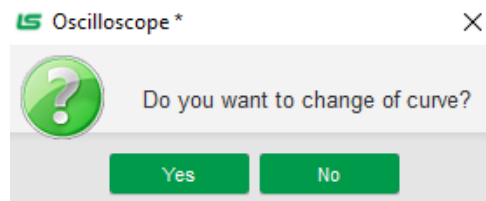

- If the box was not already selected, the window with the list of parameters opens directly.
- Select the parameter you wish to track from the drop-down list. This parameter can be an analog or digital value (regulation mode for example).
- Click “OK” to use the selected parameter, or “Cancel” if you don’t wish to change anything.

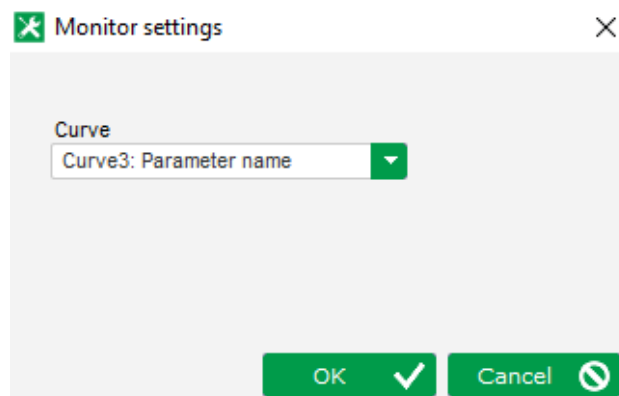

- **Enter the threshold value** to be exceeded
- **Choose the overshoot direction** (up or down)
- **To launch the trigger, click “GO”**
- **To cancel the trigger, deselect the curve**

D550

Digital Voltage Regulator

5.1.6.3. Cursors

Two cursors are available for browsing the curves. The difference between the two values of Y (curve value) is displayed in the “Delta Y” part for each curve and of “Delta X” (time in seconds) for the time between the two cursors.

Cursor			
<input checked="" type="checkbox"/>	Cursor 1	—	?
<input checked="" type="checkbox"/>	Cursor 2	—	
C	Y Curs1	Y Curs2	Delta Y
1	0.00	0.00	0.00
2	999.90	999.90	0.00
3	0.00	0.00	0.00
4	0.00	0.00	0.00
5	0.00	0.00	0.00
6	0.00	0.00	0.00
7	0.00	0.00	0.00
8	0.00	0.00	0.00
C	X Curs1	X Curs2	Delta X
	2.10	3.87	1.77

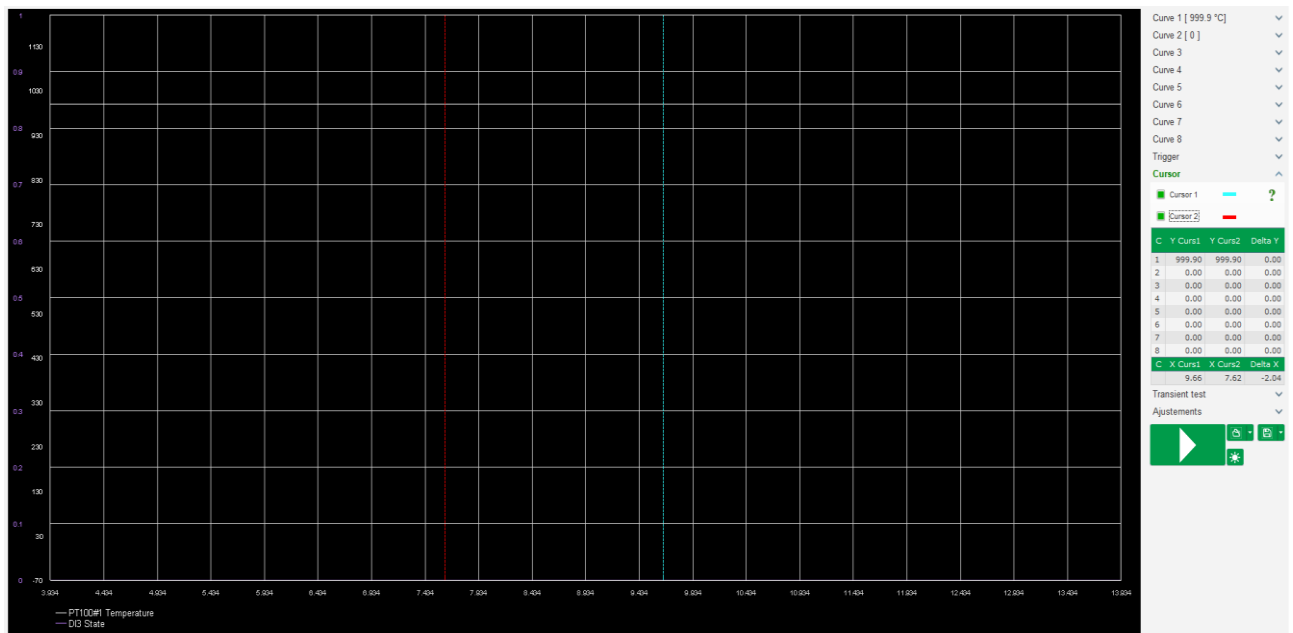

D550

Digital Voltage Regulator

5.1.6.4. Transient test

The transient test is used to check the PID response when changing the reference of current regulation mode.

It is divided into 5 steps maximum, each one can take a different reference value. The PID parameters can be changed directly when the command is sent.

- Click on the “Start a transient test” button. The following window opens:

- To configure your transient test:
 - Select between 1 and 5 steps by clicking on the corresponding tick box
 - For each selected step, define the reference value
 - Define the time between each step
- The PID values can be changed in order to adjust the gains.

Once the parameters have been set, click “OK”.

The test then starts. Steps in progress are shown by the reference turning green.

Note:

- This test can be stopped at any time by clicking on the “Stop the transient test” button. The display then reverts to the original reference.
- Transient tests cannot be performed if the control reference input is controlled by an analog input, as this control mode has priority.
- During this transient test, the defined minimum and maximum upper and lower limits are not exceeded.

D550

Digital Voltage Regulator

5.1.6.5. Open a curve or an oscilloscope display configuration

The “Open” button (folder icon) at the bottom right of the oscilloscope window can be used to open an oscilloscope display configuration file (curves, minimum and maximum values, etc.).

By clicking on this folder’s right-hand arrow, you can choose to also open a file saved in “.csv” format. Caution, only files generated by the software can be opened.

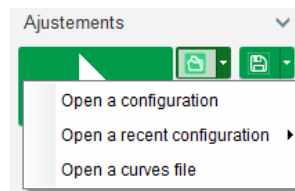

When a curve in “.csv” format is opened, the curve configuration in progress is replaced by the saved curve configuration.

There are two ways to zoom in:

- Click in the oscilloscope plotting area
- Holding the “Ctrl” key and use the mouse wheel: both the X and Y axes are then modified
- Holding the “Alt” key and scroll the mouse wheel: only the X axis is modified, the scales on the Y axis remain the same
- Holding the “Shift” key and scroll the mouse wheel: only the Y axis is modified, the scales on the X axis remain the same

5.1.6.6. Save a curve or an oscilloscope display configuration

The “Save” button (disk icon) at the bottom right of the oscilloscope window can be used to save an oscilloscope display configuration file (curves, minimum and maximum values, etc.).

By clicking on this folder’s right-hand arrow, you can choose to also save the oscilloscope curves as a “.csv” file.

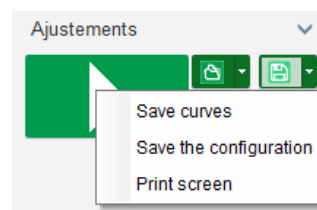

5.1.6.7. Change the background of the grid plotting area and the thickness of the curves

The oscilloscope background color can be changed to white by clicking on “☀️”. To switch back to black, click on “🌙”. Click “📊” to change the grid display. The “1” button is used to select from 4 different curve thicknesses.



D550

Digital Voltage Regulator

5.1.7. “Monitor” window

This window is used to configure the parameter display in different forms (gauges, graphs, display units), as well as certain AVR-specific components: PQ diagram, I/O, temperatures.

It is fully configurable and the various objects can be added, moved, modified and/or deleted.

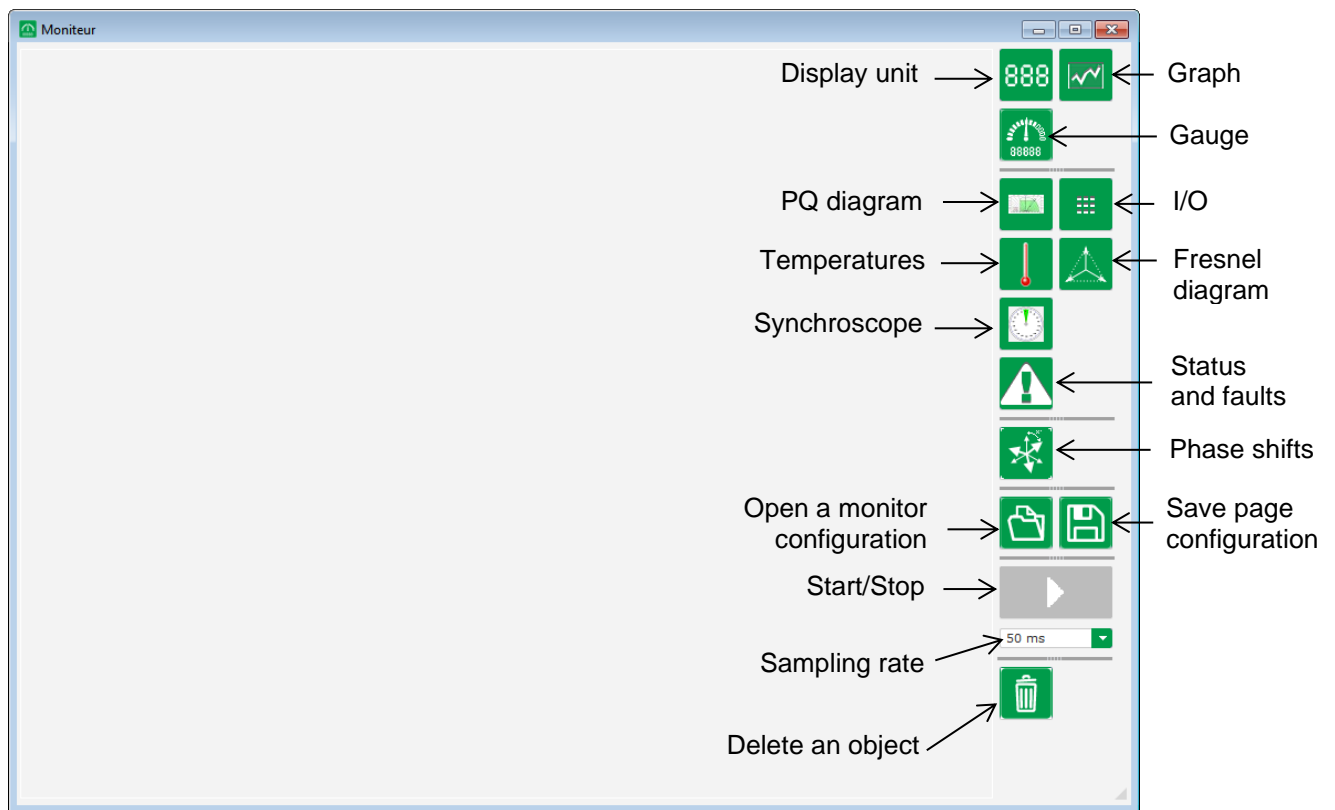

5.1.7.1. Display units

To add a new display unit:

- Click on the “Display” button, a window is opened.
- Select the parameter you wish to track from the drop-down list. This parameter can be an analog or digital value (regulation mode for example).

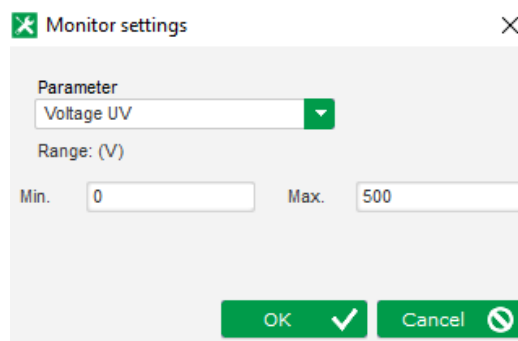

- Click “OK” to use the selected parameter, or “Cancel” if you don’t wish to change anything.

D550

Digital Voltage Regulator

- The display unit is then inserted in the monitor in the first free slot (from left to right and then from top to bottom).

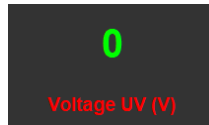

5.1.7.2. Graph

To add a new graph:

- Click on the “Graph” button, a window is opened.
- Select the parameter you wish to track from the drop-down list. This parameter can be an analog or digital value (regulation mode for example).

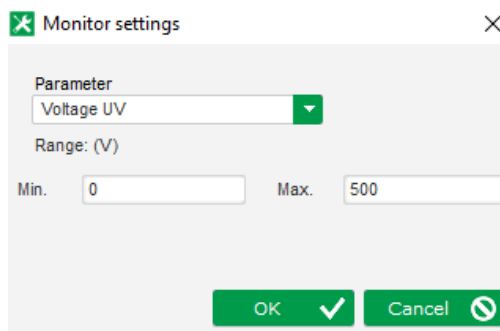

- Click “OK” to use the selected parameter, or “Cancel” if you don’t wish to change anything.
- The graph is then inserted in the monitor in the first free slot (from left to right and then from top to bottom).

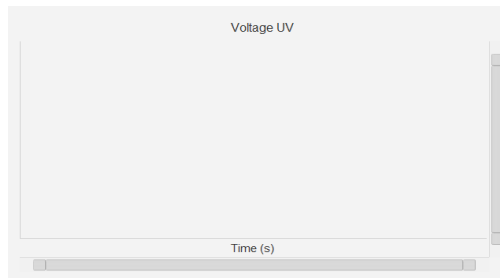

5.1.7.3. Gauges

To add a new gauge:

- Click on the “Gauge” button, a window is opened.
- Select the parameter you wish to track from the drop-down list. This parameter can be an analog or digital value (regulation mode for example).

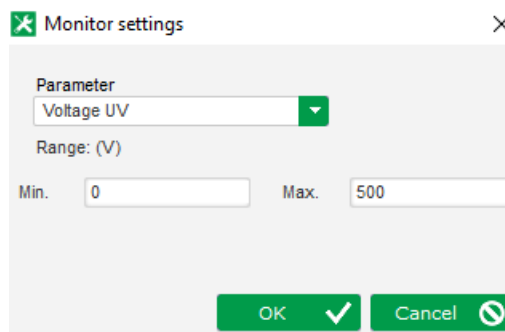

- Click “OK” to use the selected parameter, or “Cancel” if you don’t wish to change anything.

D550

Digital Voltage Regulator

- The gauge is then inserted in the monitor in the first free slot (from left to right and then from top to bottom).

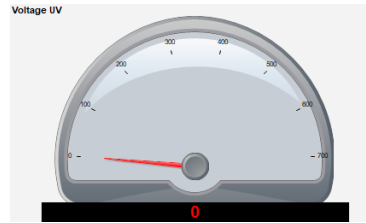

5.1.7.4. Capability curve

To add a capability curve, click on the corresponding button. The curve is then inserted in the monitor in the first free slot (from left to right and then from top to bottom).

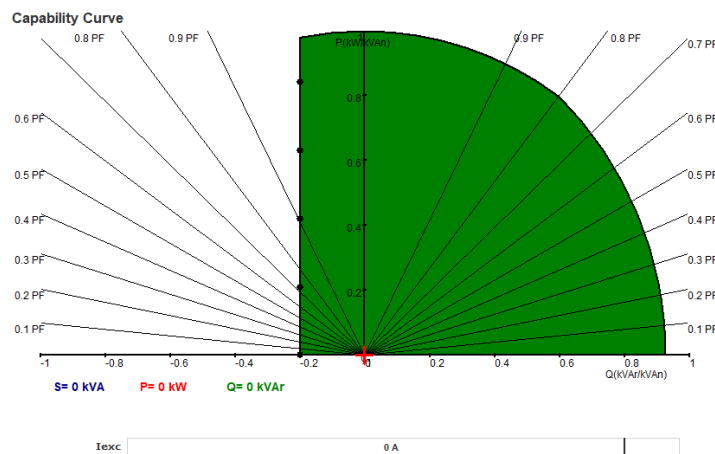

NB: Only one PQ diagram can be displayed.

5.1.7.5. I/O

To add the I/O module, click on the corresponding button. The module is then inserted in the monitor in the first free slot (from left to right and then from top to bottom).

Digitals inputs									
1	2	3	4	5	6	7	8		
<input type="checkbox"/>	<input type="checkbox"/>	<input type="checkbox"/>	<input type="checkbox"/>	<input type="checkbox"/>	<input type="checkbox"/>	<input type="checkbox"/>	<input type="checkbox"/>		
Digitals outputs									
1	2	3	4	5	6	7	8	9	10
<input type="checkbox"/>	<input type="checkbox"/>	<input type="checkbox"/>	<input type="checkbox"/>	<input type="checkbox"/>	<input type="checkbox"/>	<input type="checkbox"/>	<input type="checkbox"/>	<input type="checkbox"/>	<input type="checkbox"/>
Analgos inputs									
1	30.0 %	<input type="checkbox"/>	2	30.0 %	<input type="checkbox"/>				
3	30.0 %	<input type="checkbox"/>	4	30.0 %	<input type="checkbox"/>				
Analgos outputs									
1	30.0 %	<input type="checkbox"/>	2	30.0 %	<input type="checkbox"/>				
3	30.0 %	<input type="checkbox"/>	4	30.0 %	<input type="checkbox"/>				

NB: Only one I/O module can be displayed.

D550

Digital Voltage Regulator

5.1.7.6. Temperatures

To add the temperature module, click on the corresponding button. The module is then inserted in the monitor in the first free slot (from left to right and then from top to bottom).

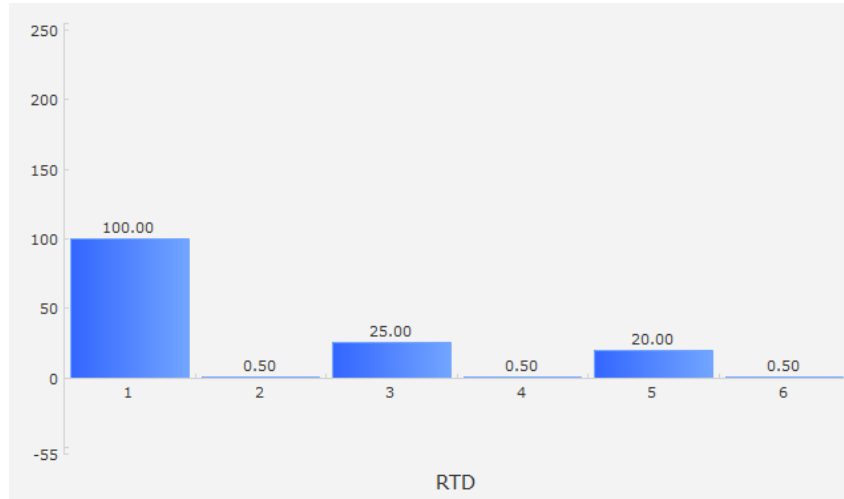

NB: Only one temperature module can be displayed.

5.1.7.7. Synchronization

To add the synchronization module, click on the corresponding button. The module is then inserted in the monitor in the first free slot (from left to right and then from top to bottom).

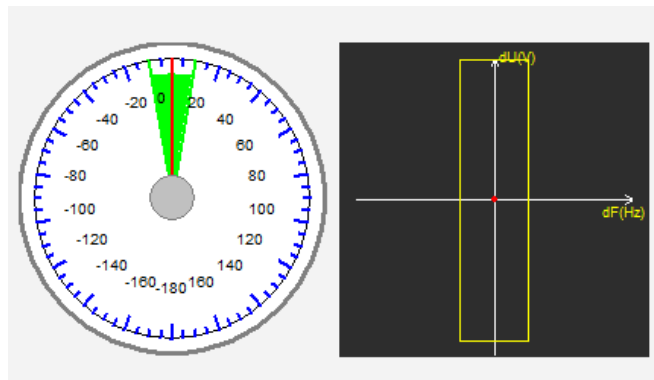

In the left-hand section, the gauge indicates the angle difference between the grid and alternator voltages. In the right-hand section, the graph indicates with a red dot whether the difference in frequency and voltage between the alternator and the grid voltage is in the configured range.

NB: Only one synchronization module can be displayed.

5.1.7.8. AVR status and faults

To add the AVR status and fault module, click on the corresponding button. The module is inserted in the monitor in the first free slot (from left to right and then from top to bottom).

D550

Digital Voltage Regulator

Fault active list

This module contains the D550 operating information, the regulation mode in progress, as well as the list of active faults.

5.1.7.9. Fresnel diagram

This module is used to display the alternator Fresnel diagram with the current, voltage and current phase shift values for each phase.

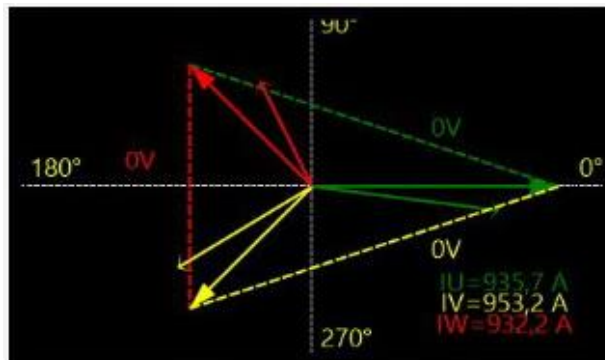

5.1.7.10. CT phase shift

This module is used to display or modify the phase shift for the different CTs directly from the monitor. To modify the value, enter the new phase shift value and click "Close".

CT phase shift ✕

CT Alternator Phase shift (°)

CT Grid Phase shift (°)

CT CrossCurrent Phase shift (°)

Close

5.1.7.11. Change the size of an object

It is possible to change the size of graphs, gauges and the PQ diagram.

- Switch to Edit mode by right-clicking in the monitor area
- Click on "Edit mode"

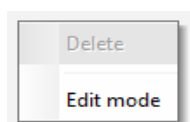

D550

Digital Voltage Regulator

- Go to the middle of one side or corner of the diagram: the cursor becomes a double arrow.

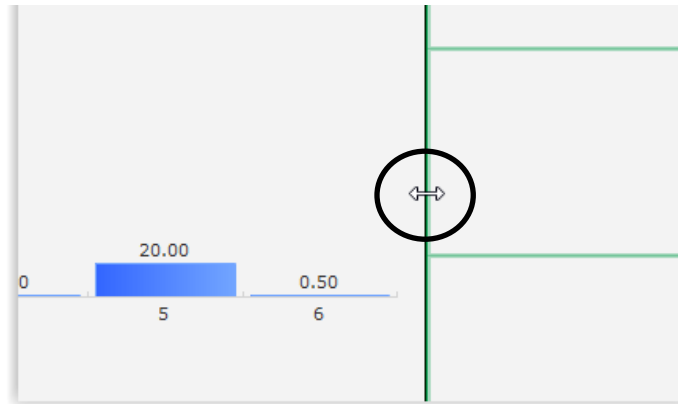

- Click, hold and drag until it is the desired size.

Exit "Edit mode" either by pressing the "Esc" key or by right-clicking in the monitor area and deselecting "Edit mode".

5.1.7.12. Delete an object

To delete an object (display unit, graph, gauge, etc.):

- Switch to Edit mode by right-clicking in the monitor area
- Click on "Edit mode"

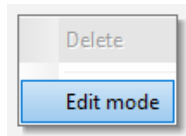

- A grid then appears indicating the position of the various objects
- Right-click on the display unit you wish to delete
- Click "Delete"

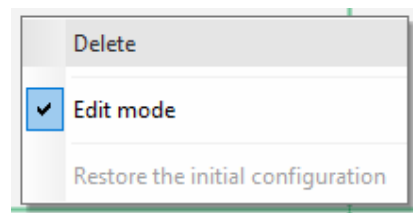

Exit "Edit mode" either by pressing the "Esc" key or by right-clicking in the monitor area and deselecting "Edit mode".

5.1.7.13. Save a monitor configuration

A monitor configuration can be saved in order to be reused later. Click on the "Save" button and a window will be opened. Give the name of the desired monitor configuration, and select "Save".



D550

Digital Voltage Regulator

5.1.7.14. Open a monitor configuration

Click on the “Open” button to retrieve a monitor configuration and a window will be opened. Select the desired monitor configuration, and select “Open”.

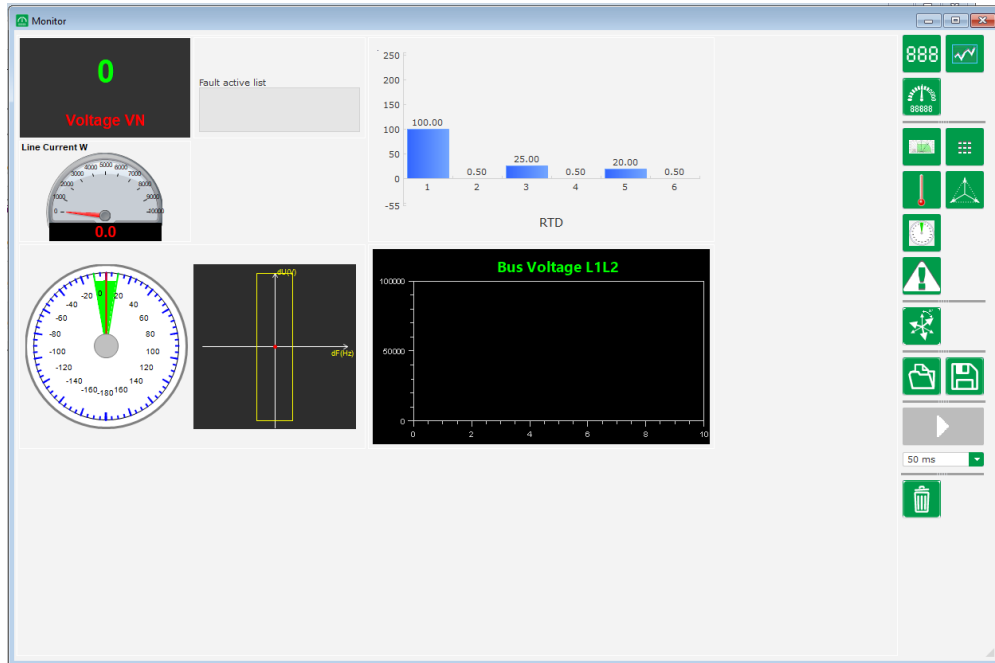

5.2. Create a new configuration

Two configuration modes are possible on the D550: “quick” or “advanced”.

- **Quick configuration:** In this mode, the machine is selected from a database with the alternator’s saved factory parameters. The pages accessible in this mode will be marked by the symbol 

Click on “New quick configuration” to access this mode.

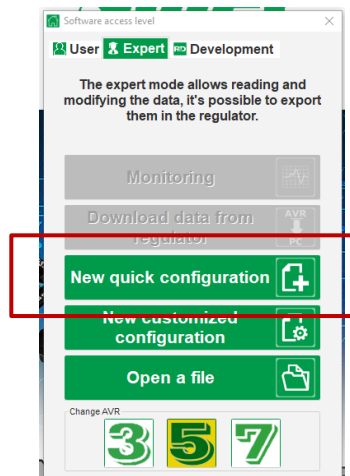

Note: It will be possible to create a quick configuration and refine the parameters on the last configuration page (the PID gains page) by continuing the configuration in advanced mode.

D550

Digital Voltage Regulator

- **Advanced configuration:** In this mode, all the machine operating parameters need to be defined. The pages accessible in this mode will be marked by the symbol 

Click on “New advanced configuration” to access this mode.

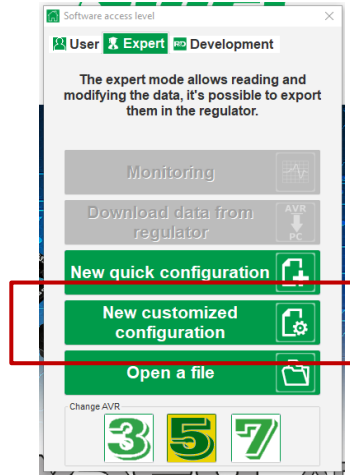

This configuration window consists of several pages for configuring the entire alternator operation. To scroll through the pages use the “Next” or “Previous” buttons or click on the list of pages.

5.2.1. Description of the “quick” alternator configuration

Select each of the following on this page:

- The size of the alternator by clicking on the corresponding image
- The various parameters:
 - The alternator core length
 - The excitation type (AREP, SHUNT or PMG)
 - The frequency and the connection diagram - the image on the right-hand side of the screen is updated according to the choices made by the user
 - The rated voltage and thermal class
 - Then click “Next”.

Generator description Next

Alternators

LSA 44.3	TAL 0 46	LSA 46.2	LSA 46.3	TAL 0 47
LSA 47.2	TAL 0 49	LSA 49.1	LSA 49.3	LSA 50.2

Length: L9

Excitation type: AREP

Nominal frequency (Hz): 50.0

Number of stator outputs: 6 wires

Stator connection diagram: CONNECTION: D

Rated voltage (V): 400

Service T°C/Class T°K: H / 125°K

3 phases

Diagram showing 3 phases: L1(U), L2(V), L3(W) and terminals T1, T2, T3, T4, T5, T6, N.

D550

Digital Voltage Regulator

5.2.2. Description of the “advanced” alternator configuration

- All the machine data needs to be defined for an advanced configuration.

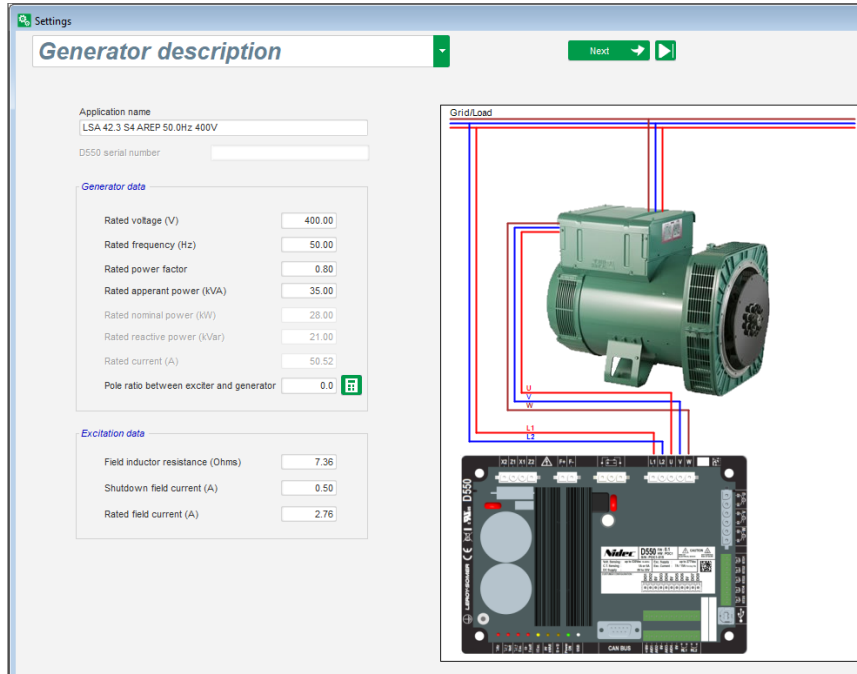

- Describe all the alternator characteristics: voltage (in Volts), apparent power (in kVA), frequency (in Hz), and power factor.
- Fields: rated current, reactive power and active power are calculated automatically.
- The ratio of the number of poles to give an accurate analysis of rotating diode failure is based on the current harmonics analysis (number of exciter poles divided by the number of machine poles). The default value is 0 and is based on the level of field current ripple.

Generator data	
Rated voltage (V)	400.00
Rated frequency (Hz)	50.00
Rated power factor	0.80
Rated apparent power (kVA)	50.00
Rated nominal power (kW)	40.00
Rated reactive power (kVar)	30.00
Rated current (A)	72.17
Pole ratio between exciter and generator	0.0

- Describe all the field excitation characteristics: exciter field resistance (in ohms), shutdown field current (in Amps), and rated field current (in Amps).

Excitation data	
Field inductor resistance (Ohms)	0.00
Shutdown field current (A)	0.50
Rated field current (A)	1.00

D550

Digital Voltage Regulator

- Click on the “Next” button.



R P 5.2.3. AVR wiring

This wiring must be typical of the connections between the AVR and the alternator. As your configuration evolves, the wiring diagram in the right of the window is changed: representation of VT and/or CT, number of conductors, etc.

Note: By default, the alternator voltage measurement and the grid code voltage measurement are shown.

- Alternator voltage measurement VTs:**

- If these are present, tick the box. The various parameters can then be set.
- State the primary and secondary winding voltages (in Volts).
- State the type of measurement: phase-neutral, phase-phase, 3 phases or 3 phases and neutral using the drop-down menu.

- Alternator current measurement CTs:**

- If these are present, tick the box. The following window appears:

In this window, it is possible to adjust the primary and secondary winding currents (in A) and also to select whether the measurement is taken for all or part of the alternator winding:

- Once this window has been closed, it is possible to adjust the various parameters.
- Indicate the IT configuration using the drop-down menu.

D550

Digital Voltage Regulator

CT connection: 0: GEN_UVW

Generator CT

Primary (A)	Secondary (A)	Phase shift (°)
1.0	1.0	0.0

Main CT

Primary (A)	Secondary (A)	Phase shift (°)
1.0	1.0	0.0

Cross current CT

Primary (A)	Secondary (A)	Phase shift (°)
1.0	1.0	0.0

Note:

- The phase shift value should be set during tests and commissioning. It is used to compensate for the phase difference caused by the CTs and VTs.
- If an isolation CT is present, the secondary parameter value should correspond to the isolation CT secondary.
- **Bus current measurement CT: placed in the V phase**
 - If this is present, choose the 4 mode. The various parameters can then be set.
 - State the primary and secondary winding currents in (Amps).
 - This input is also used for Grid code over current detection.

CT connection: 4: GEN_U_MAIN_V

Generator CT

Primary (A)	Secondary (A)	Phase shift (°)
1.0	1.0	0.0

Main CT

Primary (A)	Secondary (A)	Phase shift (°)
1.0	1.0	0.0

Cross current CT

Primary (A)	Secondary (A)	Phase shift (°)
1.0	1.0	0.0

- **Cross current measurement CT: placed in the V phase**
 - If this is present, choose the 3 mode. The various parameters can then be set.
 - State the primary and secondary winding currents in (Amps).

CT connection: 3: GEN_U_ICC

Generator CT

Primary (A)	Secondary (A)	Phase shift (°)
1.0	1.0	0.0

Main CT

Primary (A)	Secondary (A)	Phase shift (°)
1.0	1.0	0.0

Cross current CT

Primary (A)	Secondary (A)	Phase shift (°)
1.0	1.0	0.0

D550

Digital Voltage Regulator

- **Bus voltage measurement VTs:**

- If these are present, tick the box. The various parameters can then be set.
- State the primary and secondary winding voltages (in Volts).

Bus voltage PT

Primary (V): Secondary (V):

- **Step-up VT:**

- This VT corresponds to a power transformer which can be found between the alternator and the grid. It makes it easier to calculate the voltage when matching the grid voltage, especially if the ratios between the primary and secondary on the various measurement VTs are not identical.
- The “primary” corresponds to the machine (on the production side) and the secondary on the grid side.

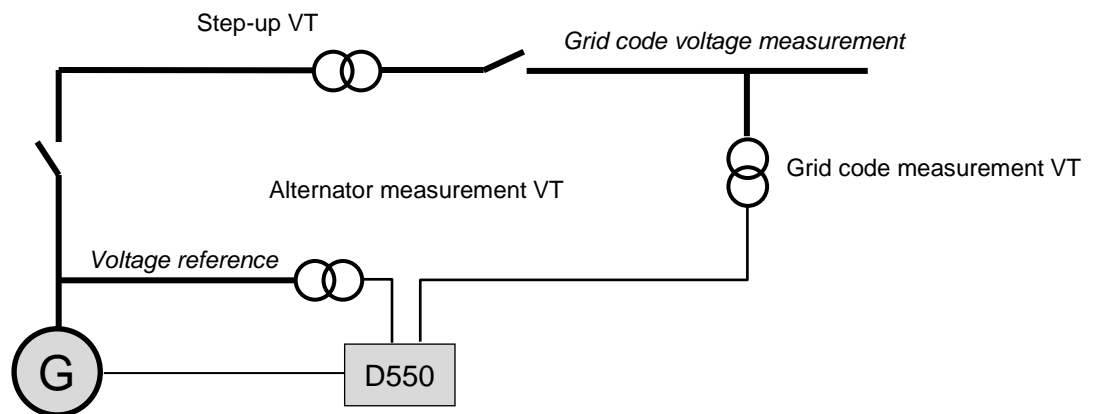

- Hence when matching the grid voltage, the voltage reference given to the AVR is calculated using the formula below:

$$\text{Voltage reference} = \text{Grid code voltage measurement} \times \frac{\text{Step-up VT primary}}{\text{Step-up VT secondary}}$$

- If this is present, tick the box. The various parameters can then be set.
- Indicate the primary and secondary winding voltages (in Volts)

Step up VT

Primary (V): Secondary (V): Phase shift (°):

Note: A phase shift adjustment is used to take the specific coupling characteristics of this step-up transformer into account.

- **PT100 and CTP:**

Select PT100 or CTP inputs.

Temperature probe(s)

RTD1 Configuration: RTD4 Configuration:

RTD2 Configuration: RTD5 Configuration:

RTD3 Configuration:

D550

Digital Voltage Regulator

5.2.4. Capability curve limit

Note: In the quick configuration, the parameters for this curve are set automatically when you select the machine.

- This limit corresponds to the absorption limit defined in the capability curve. It is drawn thanks 5 points which define the areas. We recommend using kVAr values slightly higher than the curve point so that the alternator can operate in complete safety. These points are defined as a percentage of kVA. Example of a capability curve:

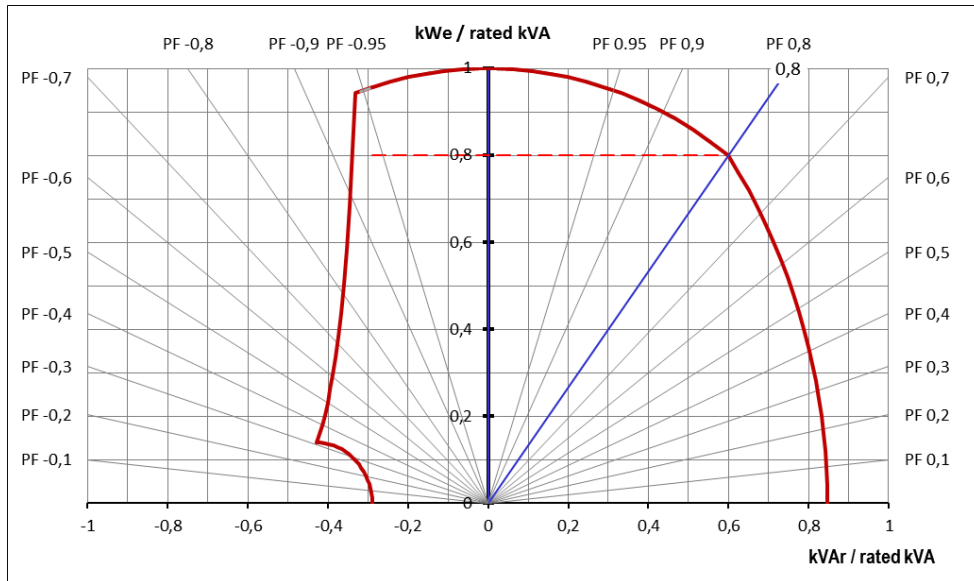

By choosing the points carefully, the software representation gives a similar diagram:

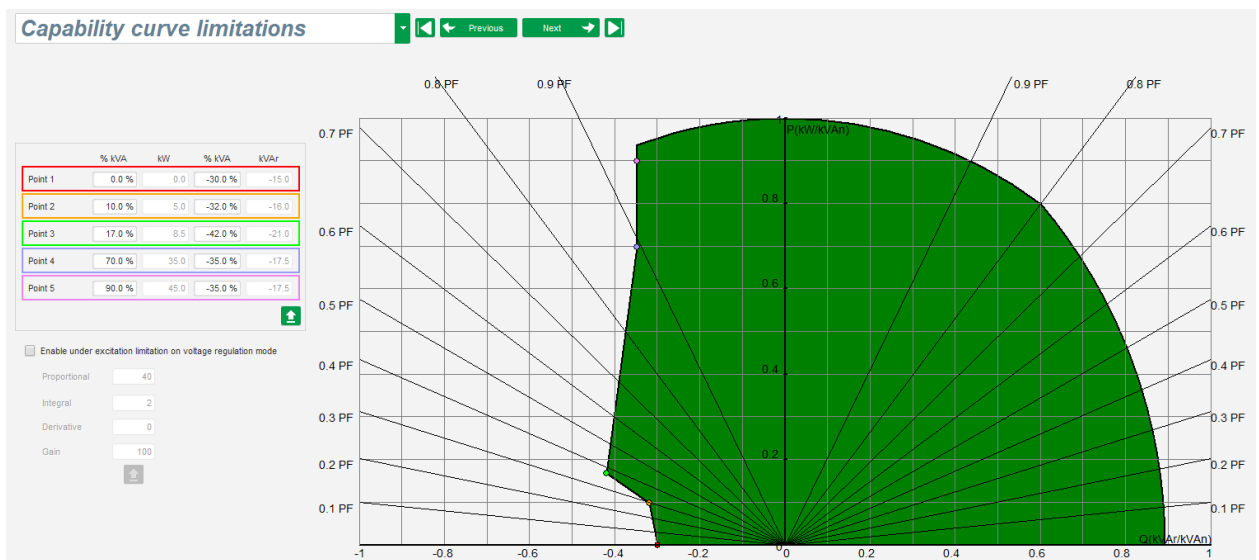

- This limit is enabled in generator power factor regulation, kVAr regulation or grid power factor regulation mode. It can also be enabled in voltage regulation mode by checking the “Enable under excitation limitation on voltage regulation mode” box. In this case, the regulation PID gains need to be defined.
- As soon as the operating point reaches this limit, the field current is controlled so that the alternator remains in the range defined by the capability curve.

D550

Digital Voltage Regulator

P 5.2.5. Definition of the over excitation limit

Note: In the quick configuration, the parameters for this curve are set automatically when you select the machine.

- This limit is divided into 3 different parts using 3 points which define the areas. These points are determined according to the machine capability. The common adjustment values are:
 - 2.5 time of the rated field current for 10 seconds for the stator short-circuit
 - 1.5 times the rated field current for 10 seconds up to 120 seconds
 - 1.1 times the rated field current for 10 seconds up to 3600 seconds
- As soon as the field current exceeds the value of the rated current, a counter is triggered. The S1 “field current measurement x time” area (shown in red below) is then compared with the “maximum field current x time” area (shown in blue below). If S1 equals S2, the limit is active and the D550 limits the field current to 99% of the rated current (which in this case results in the interruption of the regulation mode in progress).

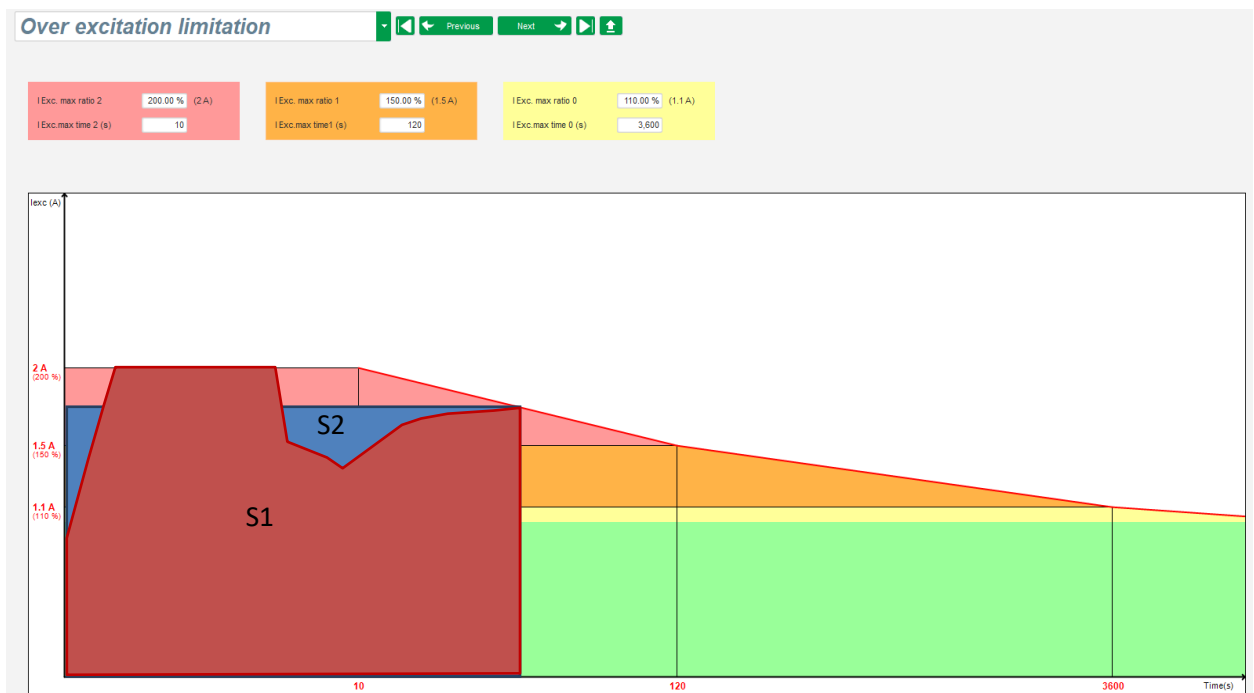

- If the limit is active, in order to protect the machine, it is only possible to have a current higher than 99% of the rated current after 24 hrs.

P 5.2.6. Definition of the stator current limit

Note: This limit is not enabled in the quick configuration.

- The principle of this limit is identical to the limit of maximum field current.
- It can only be enabled if there is at least one stator current measurement CT present.

D550

Digital Voltage Regulator

- It is divided into 3 different parts using 3 points which define the areas. These points are determined according to the machine capability. The common adjustment values are:
 - 3 times the rated stator current for 10 seconds for the stator short-circuit
 - 1.5 times the rated stator current for 120 seconds
 - 1.1 times the rated stator current for 3600 seconds
- As soon as the stator current exceeds the value of the rated current, a counter is triggered. The S1 “stator current measurement x time” area (shown in red below) is then compared with the “maximum stator current x time” area (shown in blue below). If S1 area equals S2, the limit is active and the D550 limits the stator current to 99% of the rated current (which in this case results in the voltage reference not being tracked).

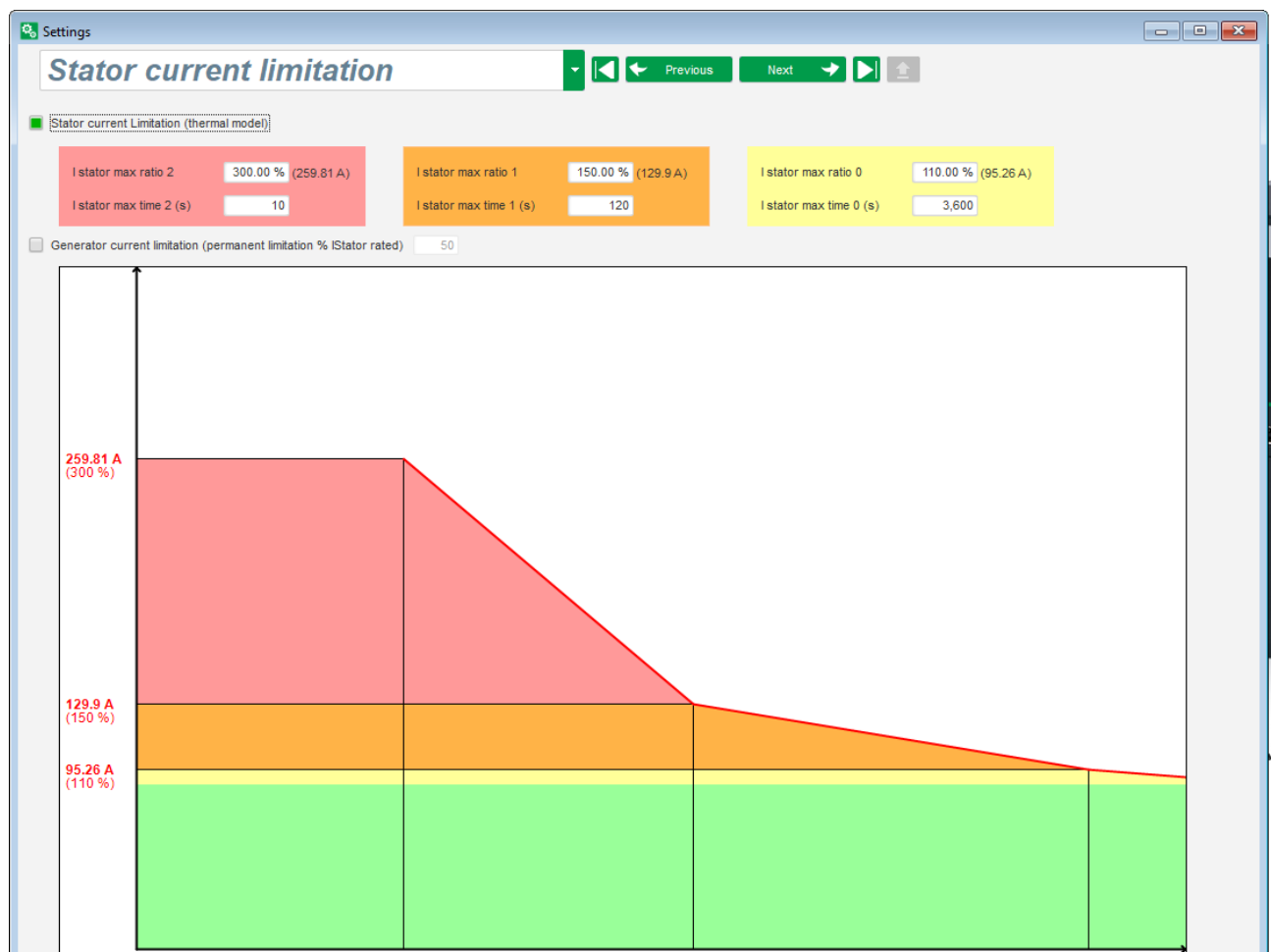

- It is also possible to limit the stator current value permanently by checking the “Permanent alternator current limit” box. In the example above, the stator current cannot exceed 320% of the rated current. The regulation loop gain can also be adjusted. This limit is useful for motor starting to limit the current delivered and ensure a gradual speed pick-up:

When the breaker is closed between the motor and the generator, the D550 continues regulating the voltage until the stator current measured reaches the limitation value. In this case, the D550 regulates the stator current. When the motor reaches its rated speed, the current will decrease naturally and the voltage will increase. The D550 will then return to voltage regulation mode.

D550

Digital Voltage Regulator

To prevent and detect a possible bad motor starting event, a delay can be set between 1s to 60s in the protections page (“motor starting” protection). If the voltage is not at its voltage setpoint when the delay is over, the regulator will then respond based on the chosen action, as for all the others fault:

- No action
- Stop the regulation
- Field current regulation mode at shutdown value
- Field current regulation mode at value before the fault

If the motor breaker is closed before energizing, this limitation has the priority and ramp time is not respected.

Note: During the motor starting, all the other limitations, faults and protections (under voltage, over voltage, stator limitation, under speed, under excitation, over excitation) has to be inactivated.

P 5.2.7. Definition of the protection functions

There are 3 types of protections:

- Generator faults
- Regulator faults
- The alarm and trip thresholds for each temperature sensor

All protections have the same architecture:

- An activation of the protection
- A threshold
- A delay
- An action to realize (or not) when the delay is over. This action is chosen in a list:
 - No action: the regulation will continue
 - Regulation stopped: the excitation is then stopped
 - Regulation in field current mode at shutdown value
 - Regulation in field current mode at the field current value before fault: no bump in the regulation

Each protection has an auto-reset option:

- If this option is selected: if fault disappears, regulation will return to the automatic mode (voltage mode, or PF mode, etc.)
- If this option is not selected, the chosen action is maintained

Below is an example for overvoltage.

Under voltage fault detected

<input type="checkbox"/> Activation	Undervoltage % setpoint (%)	85.00	<input type="checkbox"/> Auto-Reset	
	Undervoltage delay (s)	1.00	Action after fault	0: No action ▼

On activation of this fault, background becomes light green.

Under voltage fault detected

<input checked="" type="checkbox"/> Activation	Undervoltage % setpoint (%)	85.00	<input type="checkbox"/> Auto-Reset	
	Undervoltage delay (s)	1.00	Action after fault	0: No action ▼

D550

Digital Voltage Regulator

- **Under voltage and overvoltage:** These protections can be enabled by ticking the checkboxes “Activation” and defining a threshold (in percentage of the rated voltage) and a delay before the activation of the protection. In the case below:
 - Under voltage fault is activated if the generator voltage is less than 85% of the rated voltage for at least 1 second. This fault is active only if the regulation is enabled and the soft start ramp achieved.
 - Overvoltage fault is active if the generator voltage is higher than 115% of the rated voltage and for at least 1 second.

Under voltage fault detected			
<input checked="" type="checkbox"/> Activation	Undervoltage % setpoint (%)	<input type="text" value="85.00"/>	<input type="checkbox"/> Auto-Reset
	Undervoltage delay (s)	<input type="text" value="1.00"/>	Action after fault: <input type="text" value="0: No action"/>

Over voltage fault detected			
<input checked="" type="checkbox"/> Activation	Overvoltage % setpoint (%)	<input type="text" value="115.00"/>	<input type="checkbox"/> Auto-Reset
	Overvoltage delay (s)	<input type="text" value="1.00"/>	Action after fault: <input type="text" value="0: No action"/>

- **Under frequency and over frequency:** These protections can be enabled by ticking the checkboxes “Activation” and defining a frequency value and a delay before the activation of the protection. In the case below:
 - Under frequency fault is activated if the generator frequency is less than 47Hz for at least 1 seconds. This fault is active only if the regulation is enabled.
 - Over frequency fault is active if the generator frequency is higher than 53Hz for at least 1 seconds.

Under frequency fault detected			
<input checked="" type="checkbox"/> Activation	Underfrequency setpoint (Hz)	<input type="text" value="47.00"/>	<input type="checkbox"/> Auto-Reset
	Underfrequency delay (s)	<input type="text" value="1.00"/>	Action after fault: <input type="text" value="0: No action"/>

Over frequency fault detected			
<input checked="" type="checkbox"/> Activation	Overfrequency setpoint (Hz)	<input type="text" value="53.00"/>	<input type="checkbox"/> Auto-Reset
	Overfrequency delay (s)	<input type="text" value="1.00"/>	Action after fault: <input type="text" value="0: No action"/>

- **Diode fault:** These protections can be enabled by ticking the checkboxes “Activation” and defining a percentage of harmonics of the field current and a delay before the activation of the protection.
 - If the pole ratio (number of exciter poles divided by the number of poles of the generator) is known, the percentage of harmonics supervised by the AVR is the sum of the two harmonics closer of the ratio. For example, for an exciter of 16 poles, and a generator of 6 poles, pole ratio is 2.66, so the percentage of harmonics 2 and 3 are summed.
 - If the pole ratio is unknown, percentage of harmonics supervised by the AVR is the sum of all of harmonics.

In the case below:

- Open diode fault is activated if the percentage of the field current harmonics is higher than 5% for at least 1 second. This fault is active only if the regulation is enabled.
- Diode shorted fault is active if the percentage of the field current harmonics is higher than 10% for at least 1 seconds.

D550

Digital Voltage Regulator

Open diode fault detected

Activation
 Auto-Reset

Open diode percentage of field current (%)

Open diode delay (s)
 Action after fault

Shorted diode fault detected

Activation
 Auto-Reset

Shorted diode percentage of field current (%)

Shorted diode delay (s)
 Action after fault

- **Start motor fault:** This protection can be enabled by ticking the checkbox “Activation” and defining a delay. In the case below, fault is activated if the generator voltage is less than the voltage setpoint when the 30 second delay is complete. See the “Stator current limit” section for more information.

Motor start fault detected

Activation
 Auto-Reset

Motor start delay (s)

Action after fault

- **Active power reversal:** this protection device can be enabled by ticking the checkbox “Activation” and defining an active power threshold (as a percentage of the rated active power), as well as a delay before activation of the protection device.

Note: In this case, the power is negative, in other words the alternator is then in “motor” mode.

Reverse active power fault detected

Activation
 Auto-Reset

Reverse active power % setpoint (-) (%)

Reverse active power delay (s)
 Action after fault

- **Reactive power reversal:** this protection device can be enabled by ticking the checkbox “Activation” and defining a reactive power threshold (as a percentage of the rated reactive power), as well as a delay before activation of the protection device.

Note: In this case, the reactive power is negative.

Reverse reactive power fault detected

Activation
 Auto-Reset

Reverse reactive power % setpoint (-) (%)

Reverse reactive power delay (s)
 Action after fault

- **Loss of sensing:** this protection can be enabled by ticking the checkbox “Activation” and defining a voltage threshold in percentage of the generator voltage setpoint, as well as a delay before activation of the protection device. In the case below, the fault is activated if the generator voltage is less than 20% of the voltage setpoint after 1 second. This function is deactivated during the short circuit, the soft start and when the voltage is regulated according to the U/F slope.

Loss of sensing fault detected

Activation
 Auto-Reset

Lost of sensing % (%)

Lost of sensing delay (s)
 Action after fault

D550

Digital Voltage Regulator

- **Unbalance voltage:** this protection can be enabled by ticking the checkbox “Activation” and defining a percentage of voltage unbalance as well as a delay before activation of the protection device. Calculation of the voltage unbalance is according to the NEMA standard:
This function is deactivated during the soft start.

$$\text{Unbalance percentage} = \frac{\text{Maximum generator voltage}}{\text{Average of generator voltage}} \times 100$$

In the case below, this fault is activated if the percentage of unbalance is at least 20% after 1 second.

Unbalanced voltage fault detected

Activation Unbalanced voltage % (%) Auto-Reset

Unbalanced voltage delay (s) Action after fault ▼

- **Short-circuit:** this protection can be enabled by ticking the checkbox “Activation” and defining a minimum stator current threshold in percentage of the generator rated current, as well as a delay before activation of the protection device. In the case below, the fault is active if the generator current measurement is higher than 200% of the rated stator current after 10 seconds.

Short circuit fault detected

Activation Short circuit % (%) Auto-Reset

Short circuit delay (s) Action after fault ▼

- **Unbalance current:** this protection can be enabled by ticking the checkbox “Activation” and defining a percentage of current unbalance as well as a delay before activation of the protection device. Calculation of the current unbalance is realized with the same formula as the unbalance voltage.
This function is deactivated during the soft start.

$$\text{Unbalance percentage} = \frac{\text{Maximum generator current}}{\text{Average of generator current}} \times 100$$

In the case below, this fault is activated if the percentage of unbalance is at least 20% after 1 second.

Unbalanced current fault detected

Activation Unbalanced current % (%) Auto-Reset

Unbalanced current delay (s) Action after fault ▼

- **Power supply fault:** this protection can be enabled by ticking the checkbox “Activation”. It’s the result of a control of supply voltage of the D550. In the case below, the fault is active if the supply voltage is below at 10 V during 10s or more.

Battery under voltage fault detected

Activation Battery under voltage fault (V) Auto-Reset

Battery under voltage fault delay (s) Action after fault ▼

D550

Digital Voltage Regulator

- **IGBT fault:** this protection can be enabled by ticking the checkbox "Activation". The fault is activated if a coordination fault between the command and the action of the power transistors is detected, if no action is set, the AVR will continue to regulate the setpoint but with a degradation in the accuracy. It is necessary to change the D550 quickly.

IGBT fault detected

Activation

Action after fault: 0: No action

- Click on "Next" button.
- **Power bridge overload detected:** this protection can be enabled by ticking the checkbox "Activation" and defining a percentage of current unbalance as well as a delay before activation of the protection device. In the case below, the fault is active if the field current is higher than 1A after 30 seconds.

Power bridge overload fault detected

Activation

Excitation current for power bridge overload fault (A): 1.0 Auto-Reset

Power bridge overload fault delay (s): 30.0 Action after fault: 0: No action

- **Temperature protection:** these protections can be enabled by ticking the checkbox "Activation" and defining the trip and alarm temperature thresholds. The screenshot below demonstrates RTD 1 only (identical for RTD 1 to 5).

PT100 1 fault

Activation

PT100 1 alarm temperature (°C): 155 Auto-Reset

PT100 1 fault temperature (°C): 165 Action after fault: 0: No action

On the last protections page, fault groups can be defined: all protections can be grouped to activate one or several signals (digital output for example) to do a synthesis of several faults. If one of these faults is activated, the entire group is activated. This information can be a destination for one output or can be used in logical functions. In the example below, Group 1 corresponds to speed faults, Group 2 to temperature faults, Group 3 to temperature alarm faults and Group 4 to voltage unbalance and supply voltage faults.

D550

Digital Voltage Regulator

Protections

Machine fault Regulator fault Power bridge Temperature protections **Faults group**

Fault	Group 1	Group 2	Group 3	Group 4
Overvoltage fault class	<input type="checkbox"/>	<input type="checkbox"/>	<input type="checkbox"/>	<input type="checkbox"/>
Undervoltage fault class	<input type="checkbox"/>	<input type="checkbox"/>	<input type="checkbox"/>	<input type="checkbox"/>
Overfrequency fault class	<input type="checkbox"/>	<input type="checkbox"/>	<input type="checkbox"/>	<input type="checkbox"/>
Underfrequency fault class	<input type="checkbox"/>	<input type="checkbox"/>	<input type="checkbox"/>	<input type="checkbox"/>
Open diode fault class	<input checked="" type="checkbox"/>	<input type="checkbox"/>	<input type="checkbox"/>	<input type="checkbox"/>
Shorted diode fault class	<input checked="" type="checkbox"/>	<input type="checkbox"/>	<input type="checkbox"/>	<input type="checkbox"/>
Reverse active power fault class	<input type="checkbox"/>	<input type="checkbox"/>	<input type="checkbox"/>	<input type="checkbox"/>
Reverse reactive power fault class	<input type="checkbox"/>	<input type="checkbox"/>	<input type="checkbox"/>	<input type="checkbox"/>
PT100 1 Alarm (Over temp) fault class	<input type="checkbox"/>	<input checked="" type="checkbox"/>	<input type="checkbox"/>	<input type="checkbox"/>
PT100 1 fault class	<input type="checkbox"/>	<input type="checkbox"/>	<input type="checkbox"/>	<input type="checkbox"/>
PT100 2 Alarm (Over temp) fault class	<input type="checkbox"/>	<input checked="" type="checkbox"/>	<input type="checkbox"/>	<input type="checkbox"/>
PT100 2 fault class	<input type="checkbox"/>	<input type="checkbox"/>	<input type="checkbox"/>	<input type="checkbox"/>
PT100 3 Alarm (Over temp) fault class	<input type="checkbox"/>	<input checked="" type="checkbox"/>	<input type="checkbox"/>	<input type="checkbox"/>
PT100 3 fault class	<input type="checkbox"/>	<input type="checkbox"/>	<input type="checkbox"/>	<input type="checkbox"/>
PT100 4 Alarm (Over temp) fault class	<input type="checkbox"/>	<input checked="" type="checkbox"/>	<input type="checkbox"/>	<input type="checkbox"/>
PT100 4 fault class	<input type="checkbox"/>	<input type="checkbox"/>	<input type="checkbox"/>	<input type="checkbox"/>
PT100 5 Alarm (Over temp) fault class	<input type="checkbox"/>	<input checked="" type="checkbox"/>	<input type="checkbox"/>	<input type="checkbox"/>
PT100 5 fault class	<input type="checkbox"/>	<input type="checkbox"/>	<input type="checkbox"/>	<input type="checkbox"/>
PTC 1 fault class	<input type="checkbox"/>	<input type="checkbox"/>	<input type="checkbox"/>	<input type="checkbox"/>
PTC 2 fault class	<input type="checkbox"/>	<input type="checkbox"/>	<input type="checkbox"/>	<input type="checkbox"/>
PTC 3 fault class	<input type="checkbox"/>	<input type="checkbox"/>	<input type="checkbox"/>	<input type="checkbox"/>
PTC 4 fault class	<input type="checkbox"/>	<input type="checkbox"/>	<input type="checkbox"/>	<input type="checkbox"/>
PTC 5 fault class	<input type="checkbox"/>	<input type="checkbox"/>	<input type="checkbox"/>	<input type="checkbox"/>
Loss of sensing fault class	<input type="checkbox"/>	<input type="checkbox"/>	<input type="checkbox"/>	<input type="checkbox"/>
Unbalance voltage fault class	<input type="checkbox"/>	<input type="checkbox"/>	<input type="checkbox"/>	<input type="checkbox"/>
Unbalance current fault class	<input type="checkbox"/>	<input type="checkbox"/>	<input type="checkbox"/>	<input type="checkbox"/>
Short circuit fault class	<input type="checkbox"/>	<input type="checkbox"/>	<input type="checkbox"/>	<input type="checkbox"/>
IGBT fault class	<input type="checkbox"/>	<input type="checkbox"/>	<input type="checkbox"/>	<input type="checkbox"/>
Motor start fault class	<input type="checkbox"/>	<input type="checkbox"/>	<input type="checkbox"/>	<input type="checkbox"/>
Power bridge overload fault class	<input type="checkbox"/>	<input type="checkbox"/>	<input type="checkbox"/>	<input type="checkbox"/>
Battery under voltage fault class	<input type="checkbox"/>	<input type="checkbox"/>	<input type="checkbox"/>	<input type="checkbox"/>
CAN under voltage fault class	<input type="checkbox"/>	<input type="checkbox"/>	<input type="checkbox"/>	<input type="checkbox"/>

- Click on “Next” button.

R **P** 5.2.8. Regulation mode

R **P** 5.2.8.1. Starting

- The ramp time corresponds to the time taken to reach the machine’s voltage reference (or field current reference).

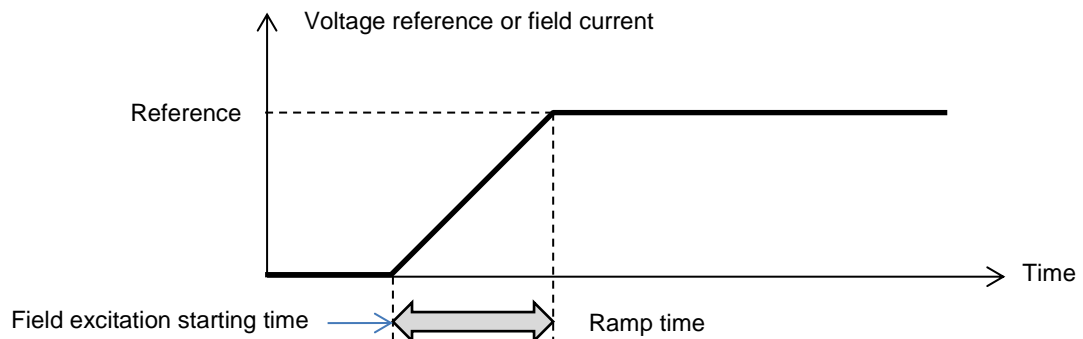

- If starting needs to be instantaneous, put “0” in the ramp time.

D550

Digital Voltage Regulator

Regulation mode

Start-up | Voltage | Volt Matching | Generator Power Factor | kVAr | Grid Power Factor | Field Current

Start enabled by: Always enabled

Soft-start duration (s): 15.0

Start on threshold

Start on Threshold (SoT) Mode Active

Voltage Threshold (V): 0.0

Initial PWM SoT (%): 0.0 ?

Minimum frequency threshold to reset the threshold start (Hz): 6.0

Minimum Vbus voltage threshold to reset the threshold start (V): 20.0

Delay to reset the threshold start (s): 0.0

- Select the field excitation starting mode from the drop-down list. This can be:
 - Controlled by a digital input (DI1 to DI8).
 - Not controlled directly, but the result of a logic gate for example.
 - Always enabled by selecting “Always active”. In this case, the field excitation is always energized as soon as the product is powered up. This offers two possible scenarios:
 - **Start on threshold mode is not active:** The ramp will then be active as soon as the alternator starts to rotate, and the reference will be corrected according to the underspeed slope parameter set in voltage regulation mode (see the next section).
 - **Start on threshold mode is active.** Check the “Start on Threshold (SoT) Mode Active” box to enable this mode. It is used to start the ramp without taking the alternator speed into account by using the voltage level present at terminals X1, X2, Z1 and Z2. This mode operates in two stages:
 - Control of power transistor opening is initially maintained at a fixed valued (“Initial PWM SoT (%)”), until the alternator voltage reaches its defined value (“Voltage Threshold (V)”).
 - As soon as the machine voltage reaches this threshold, voltage regulation becomes active.

D550

Digital Voltage Regulator

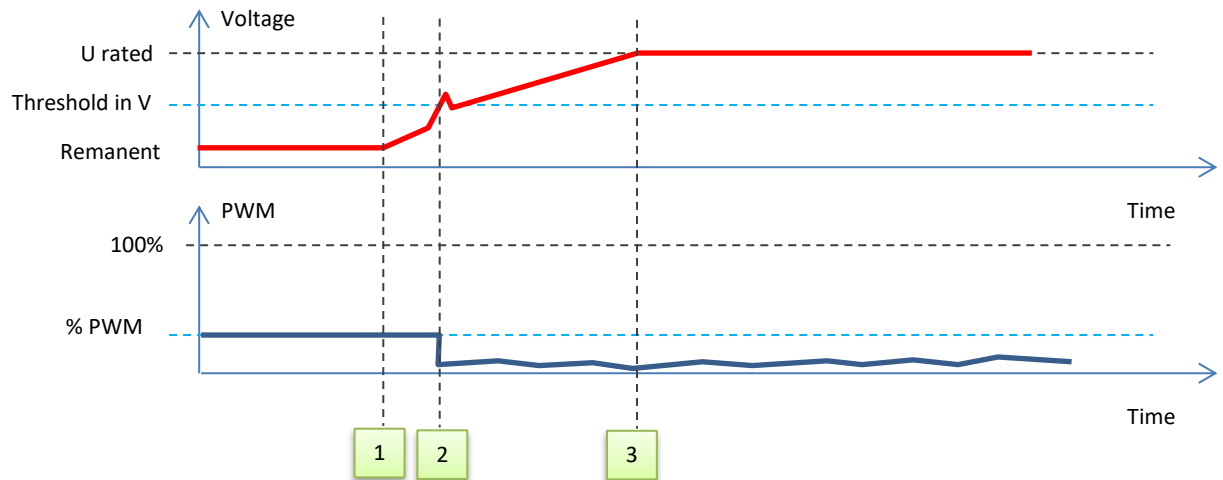

- 1** Excitation energized
- 1** to **2** Regulation with PWM applied to "Initial PWM SoT"
- 2** to **3** Voltage regulation (following the soft-start ramp)
- 3** End of ramp and regulation at U rated

- To stop excitation with starting on threshold, the following 3 conditions must be met:
 - Frequency less than the fixed frequency
 - DC bus voltage (continuous image of the voltage present at terminals X1, X2, Z1 and Z2) less than the fixed voltage level
 - A delay after validating the previous two conditions
- In the example below, for a 400V alternator:

Start on threshold

Start on Threshold (SoT) Mode Active

Voltage Threshold (V)

Initial PWM SoT (%) ?

Re-initialization threshold start conditions:

The frequency must be lower than Hz

Vbus voltage must be lower than V

Waiting delay after previous conditions enabled s

- Click on "Next" button.

D550

Digital Voltage Regulator

R P 5.2.8.2. Voltage regulation

- This regulation must always be active, so select “Always active” in the drop-down list.



- The reference point** is determined either by a fixed value in the “Internal setpoint” tab, or by an analog input, the source, type and range of which need to be defined in the “Setpoint from analog input” tab.
- If “**Internal setpoint**” is selected, fill in the voltage reference value. This value can also be modified via the fieldbus.

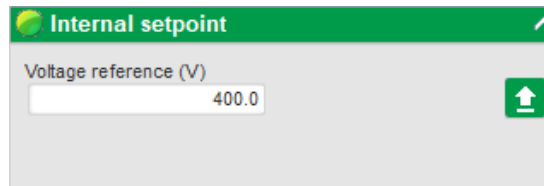

- If the “**Analog input**” option is selected, the “Setpoint from analog input” part becomes active. Select the desired analog input box, determine its mode (+/-10 V, 0/10 V, 4-20 mA, potentiometer) and the voltage values at 0% and 100%.⁹

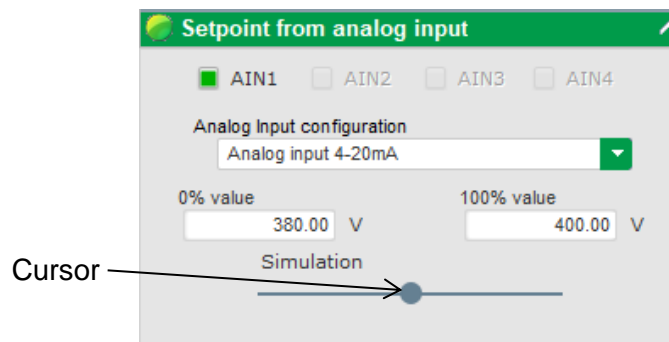

Note: By moving the cursor, it is possible to view the values obtained on the voltage and under frequency curves displayed on the right.

- The limits of this reference** should be fixed, depending on the machine capability (in the example below, the minimum voltage reference is 0% of 400 V, and the maximum voltage reference is 100% of 400 V).

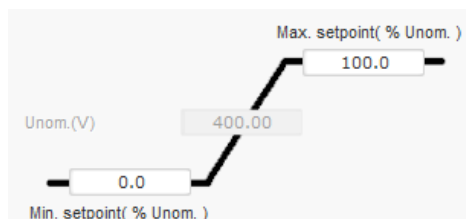

⁹ The voltage terminals can be swapped: the minimum voltage for 100% of the analog input, and the maximum voltage for 0% of the analog input.

D550

Digital Voltage Regulator

- **With a fixed reference, the reference can be adjusted** by two up and down inputs, one pulse corresponding to going up one “step” or down one “step”. Both the inputs, the value of the step and the delay need to be fixed, and this adjustment can be accessed by setting the selector to “Active”.

Note: The “+” and “-” inputs are the same for all regulation modes, but only affect the regulation modes in which they were enabled.

- **Underfrequency:** These two fields are used to set the voltage drop as a function of the alternator speed.
 - **Knee-point value:** The typical values are 48 Hz for an alternator at 50 Hz, 57 Hz for an alternator with 60 Hz rated frequency and 380 Hz for an alternator at 400 Hz.
 - **Slope:** Adjustable from 0.5 to 3. The higher the slope value, the greater the voltage drop will be if the drive motor speed drops.

- The curve drawing is changed as a function of these two values.

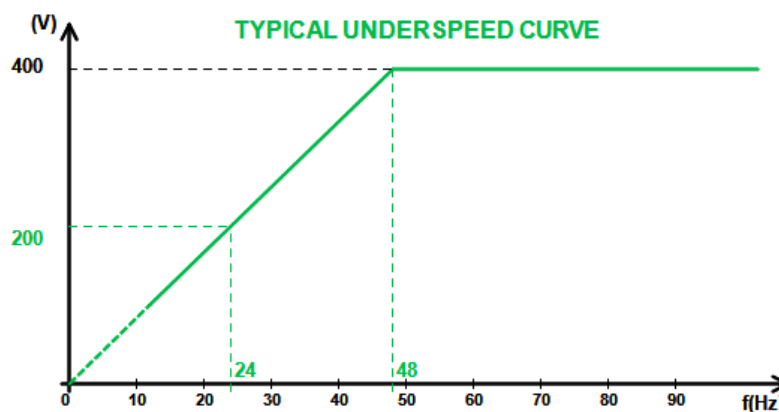

- **Quadrature droop:** Select the box to enable this function and give a voltage drop percentage between -20% and +20% (caution, a negative value corresponds to an increase in voltage). This function is mainly used in the case of alternators operating in parallel with one another. This value is set to 3% by default.

D550

Digital Voltage Regulator

The quadrature droop curve drawing is changed as a function of the reference.

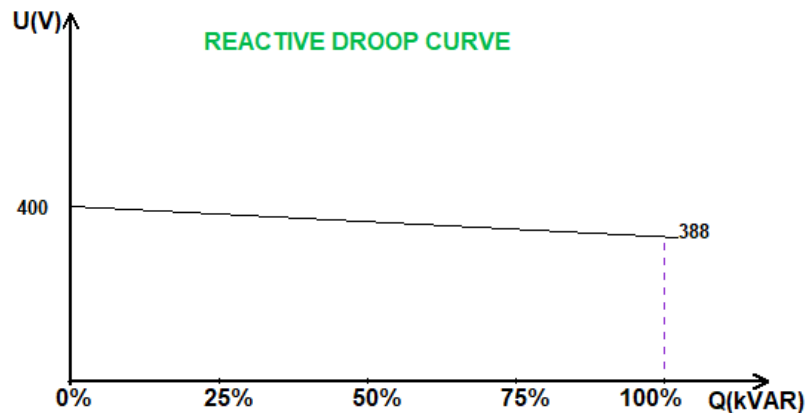

Note: If quadrature droop has been enabled, it is no longer possible to have load compensation or cross-current function.

- **Load compensation:** Select the box to enable this function and give a voltage reference change percentage between -20% and +20%. This function is mainly used, depending on the kVA delivered by the machine, to:
 - Increase the voltage reference (with a percentage between 1 and 20%) in the case of particularly long distribution lines.
 - Decrease the voltage reference (with a percentage between -20% and -1%) to balance the loads for machines connected to a rectifier (DC bus).

Voltage line drop compensation (%)

The compensation curve drawing is changed as a function of the reference.

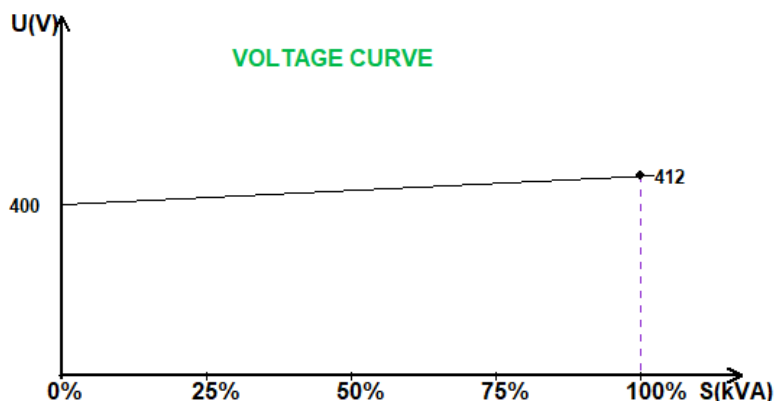

Note: If load compensation has been enabled, it is no longer possible to have quadrature droop or the cross-current function.

- **Cross current:** Select the box to enable this function and give a voltage correction percentage as a function of the measured residual kVAR. The system automatically corrects the voltage (temporarily) to permanently cancel the kVAR difference between machines, yet without lowering the regulation point. This function requires special wiring.

Cross Current (% Voltage setpoint)

D550

Digital Voltage Regulator

Note: If the cross-current function has been enabled, it is no longer possible to have quadrature droop or load compensation.

- **This function is only possible if a cross current CT is wired to the V input on the D550.**
- **LAM:** Load Acceptance Module. This function improves the generator response reducing the voltage set point during a load impacts. When generator frequency measured is below the under-speed knee defined in the configuration (example 48Hz or 57Hz), voltage set point is decreased to a defined value (in example below, 10% under the rated voltage).

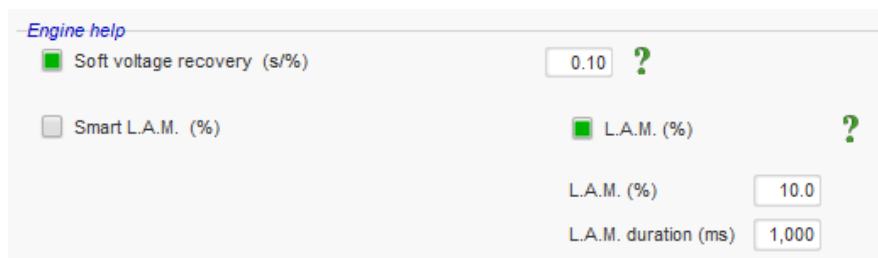

- If frequency continues to fall, the voltage is regulated according to the U/f law.
- Soft voltage recovery helps the speed recovery of the genset: it is given in seconds per percent of the rated voltage (s/%). For example, the above setting means that if the frequency decreases by 10% then the progressive rise time will be 1 second (i.e. $0.100\text{s}/\% \times 10\%$). Note that if the slope of progressive rise is greater than the U/f law, then the latter will be used to raise the voltage.
- The frequency stabilization delay corresponds to the waiting time before the voltage setpoint is raised gradually (according to the increase of the frequency).
- The figure below shows the operating details of the LAM:

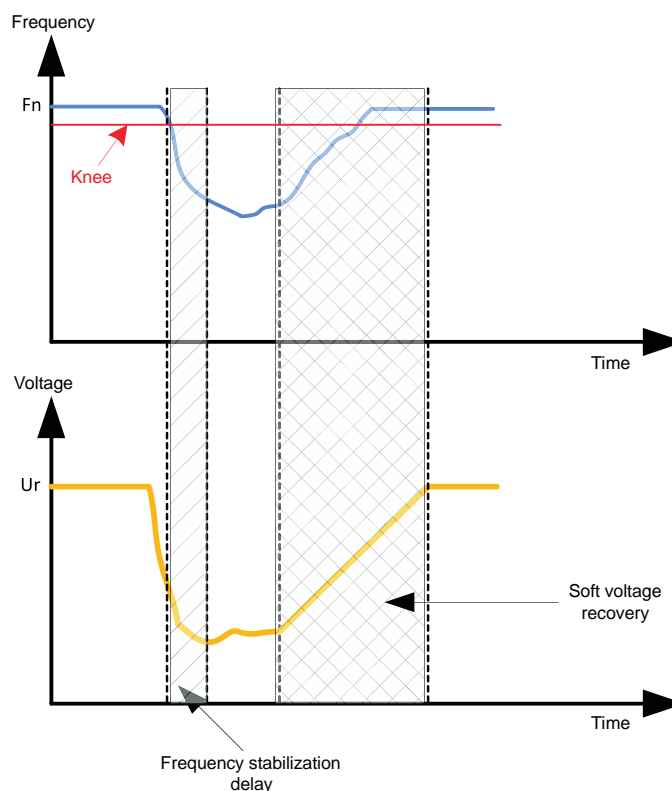

D550

Digital Voltage Regulator

- **Smart LAM:** it has the same role as the classical LAM described above. The difference lies in the fact that the percentage of voltage drop is no longer fixed by the user but is automatically adapted to the level of the load impact. Thus, for each load impact:
 - The controller measures the operating frequency and calculates its derivative permanently.
 - From this derivative value, an attenuation coefficient (K) of the voltage is calculated according to the parameters configured by the user. In the example below, for a frequency variation of 10Hz/s, the applied voltage drop will be 10% of the nominal voltage.

Engine help

Soft voltage recovery (s/%) ?

Smart L.A.M. (%) L.A.M. (%) ?

L.A.M. % for Hz/s frequency drop speed.

L.A.M. duration (ms)

For each load impact, the voltage attenuation is determined by the formula $\Delta U = K \times U_r$ where U_r is the rated voltage of the alternator.

The frequency stabilization delay corresponds to the waiting time before the voltage setpoint is raised gradually (according to the increase of the frequency).

- Click on the “Next” button.

R

P

5.2.8.3. Voltage matching circuit

- To connect an alternator to the grid, the grid voltage and the alternator voltage must be very close in value (less than 5% difference between the two measurements). The voltage matching circuit function is used to measure the instantaneous grid voltage as an alternator voltage reference.¹⁰
- To enable the voltage matching circuit, select the activation type from the drop-down list. This can be:
 - Controlled by a digital input (DI1 to DI8).
 - Always enabled by selecting “Always active”. In this case, the voltage matching circuit is always switched on, depending on the order of priority of the regulations.
 - If “None” is selected, the voltage matching circuit is never enabled or is enabled by a logic gate.

Start-up Voltage Volt Matching

Regulation enabled by
DI3

- Click on the “Next” button.

¹⁰ This function requires one or two grid voltage measurement transformer(s).

D550

Digital Voltage Regulator

R P 5.2.8.4. Regulation of the generator power factor

- This regulation must be enabled as soon as the machine is connected to the grid (grid contactor closing) data item and disabled as soon as the machine is disconnected from the grid. The source of the grid connection contactor should be stated at the bottom of the page:

Grid breaker Input:
DI4

- It can be chosen with kVAr regulation and regulation of the power factor at one point of the grid for machines connected to the grid.
- This function is used to regulate the power factor at the machine terminals. For this purpose, the alternator current measurement must be connected (1 or 3 current transformers).
- This regulation is activated by default as soon as the grid breaker is closed. The other regulation modes kVAr or power factor at a grid point, have the priority on this regulation.
- The reference point** is determined either by a fixed value in the “Internal setpoint” tab, or by an analog input, the source, type and range of which need to be set in the “Setpoint from analog input” tab.
- If “**Internal setpoint**” is selected, fill in the voltage reference value. This value can also be modified via the fieldbus.

Internal setpoint
Generator PF reference
0.800

- If the “**Analog input**” option is selected, the “Reference via analog input” part becomes active. Select the desired analog input box, determine its mode (+/-10 V, 0/10 V, 4-20 mA, potentiometer) and the power factor values at 0% and 100%. ¹¹

Setpoint from analog input
 AIN1 AIN2 AIN3 AIN4
 Analog Input configuration
 Analog input 4-20mA
 0% value: 1.00 100% value: 0.80
 Simulation
 Cursor →

Note: By moving the cursor, it is possible to view the power factor reference (blue line) on the capability diagram located on the right of the page.

¹¹ The power factor reference can be swapped and the limits reversed: the minimum power factor for 100% of the analog input, and the maximum power factor for 0% of the analog input.

D550

Digital Voltage Regulator

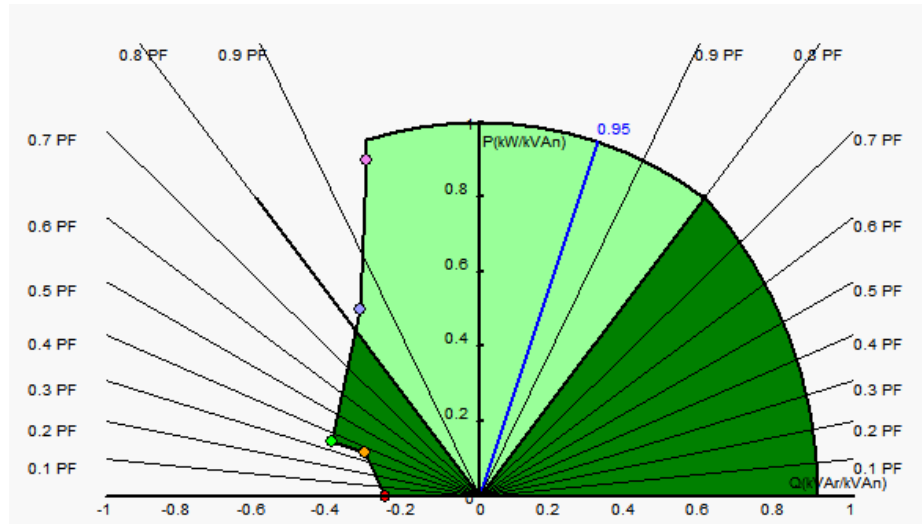

- **With a fixed reference, the reference can be adjusted** by two inputs (up and down), one pulse corresponding to going up one “step” or down one “step”. Both the inputs, the value of the step and the delay need to be fixed, and this adjustment is enabled by setting the selector to “Active”.

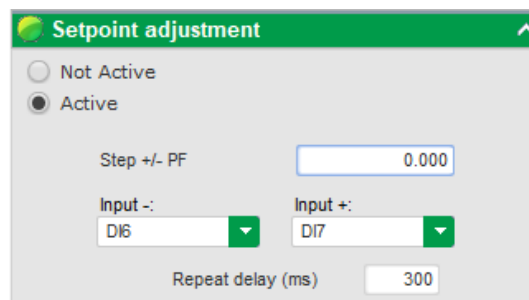

Note: The “+” and “-” inputs are the same for all regulation modes.

- **The limits of this reference** should be fixed according to the machine capability (in the example below, the power factor reference is fixed between 1 and 0.8 (supplying reactive power as seen by the generator)).

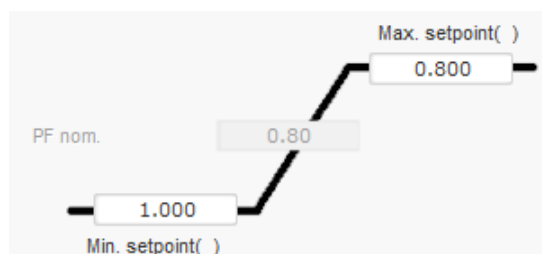

These reference limits define the light green area on the capability diagram in which the reference can vary.

D550

Digital Voltage Regulator

5.2.8.5. Regulation of generator kVAr

- This regulation must be enabled as soon as the machine is connected to the grid “grid contactor closing” data item), and disabled as soon as the machine is disconnected from the grid. The grid connection contactor source should be stated at the bottom of the page:

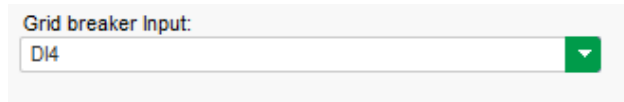

Grid breaker Input:
DI4

- The other options are regulation of the generator power factor or regulation of the power factor at one point of the grid for machines connected to the grid (see steps 10 and 12).
- This regulation is used to regulate the kVAr value at the machine terminals. For this purpose the alternator current measurement must be connected (1 or 3 current transformers).
- To enable kVAr regulation, select the activation type from the drop-down list. This can be:
 - Controlled by a digital input (DI1 to DI8).
 - Always enabled by selecting “Always active”. In this case, kVAr regulation is always active, depending on the order of priority of the regulations.
 - If “None” is selected, kVAr regulation is never enabled or is enabled by a logic gate.

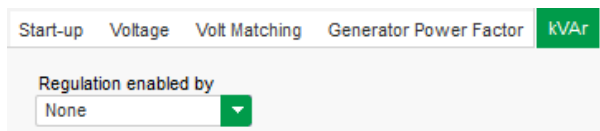

Start-up Voltage Volt Matching Generator Power Factor kVAr

Regulation enabled by
None

- **The home reference point** is determined either by a fixed value in the “Internal setpoint” tab, or by an analog input, the source, type and range of which need to be set in the “Setpoint from analog input” tab.
- If “**Internal setpoint**” is selected, fill in the voltage reference value. This value can also be modified via the fieldbus.

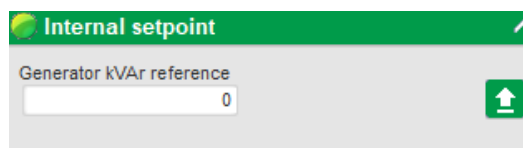

Internal setpoint

Generator kVAr reference
0

- If the “**Analog input**” option is selected, the “Reference via analog input” part becomes active. Select the desired analog input box, determine its mode (+/-10 V, 0/10 V, 4-20 mA, potentiometer) and the kVar values at 0% and 100%.¹²

¹² The kVAr regulation terminals can be swapped and the limits reversed: the minimum value for 100% of the analog input, and the maximum value for 0% of the analog input.

D550

Digital Voltage Regulator

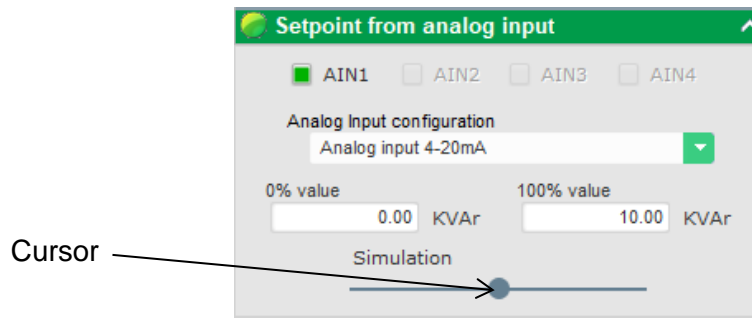

Note: By moving the cursor, it is possible to view the kVAr regulation (blue line) on the capability diagram located on the right of the page.

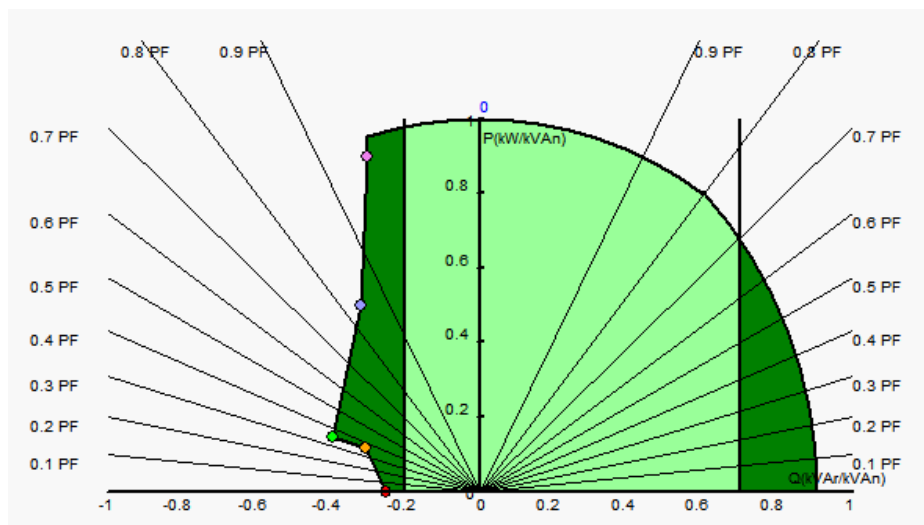

- **With a fixed reference, the reference can be adjusted** by two inputs (up and down), one pulse corresponding to going up one “step” or down one “step”. Both the inputs, the value of the step and the delay need to be fixed, and this adjustment is enabled by setting the selector to “Active”.

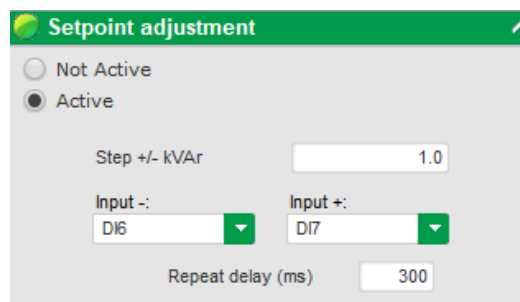

Note: The “+” and “-” inputs are the same for all regulation modes.

- **The limits of this reference** should be fixed according to the machine capability (in the example below, the kVAr regulation is fixed between -10% of the alternator rated kVA power (drawing reactive power as seen by the generator) and 62% of the alternator rated kVA power (supplying reactive power as seen by the generator)).

D550

Digital Voltage Regulator

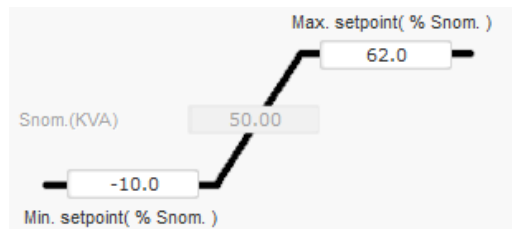

These reference limits define the light green area on the capability diagram in which the reference can vary.

R

P

5.2.8.6. Regulation of power factor at one point of the grid

- This regulation mode is only possible if a grid current measurement CT is wired to the V input on the D550.
- This regulation must be enabled as soon as the machine is connected to the grid “grid contactor closing” data item) and disabled as soon as the machine is disconnected from the grid. The grid connection contactor source should be stated at the bottom of the page:

- The other options are regulation of the generator power factor and kVAr regulation for machines connected to the grid (see steps 10 and 11).
- This regulation is used to regulate the power factor at one point of the grid. For this purpose, the alternator current measurement must be connected.
- To enable regulation of the power factor at one point of the grid, select the activation type from the drop-down list. This can be:
 - Controlled by a digital input (DI1 to DI8).
 - Always enabled by selecting “Always active”. In this case, regulation of the power factor at one point of the grid is always enabled, according to the order of priority of the regulations.
 - If “None” is selected, regulation of the power factor at one point of the grid is never enabled or is enabled by a logic gate.

- **The home reference point** is determined either by a fixed value in the “Internal setpoint” tab, or by an analog input, the source, type and range of which need to be set in the “Setpoint from analog input” tab.
- If “**Internal setpoint**” is selected, fill in the voltage reference value. This value can also be modified via the fieldbus.

D550

Digital Voltage Regulator

- If the “Analog input” option is selected, the “Reference via analog input” part becomes active. Select the desired analog input box, determine its mode (+/-10 V, 0/10 V, 4-20 mA, potentiometer) and the power factor values at 0% and 100%.¹³

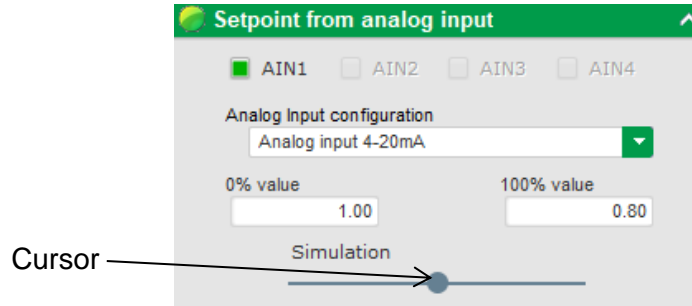

Note: By moving the cursor, it is possible to view the power factor reference (blue line) on the capability diagram located on the right of the page.

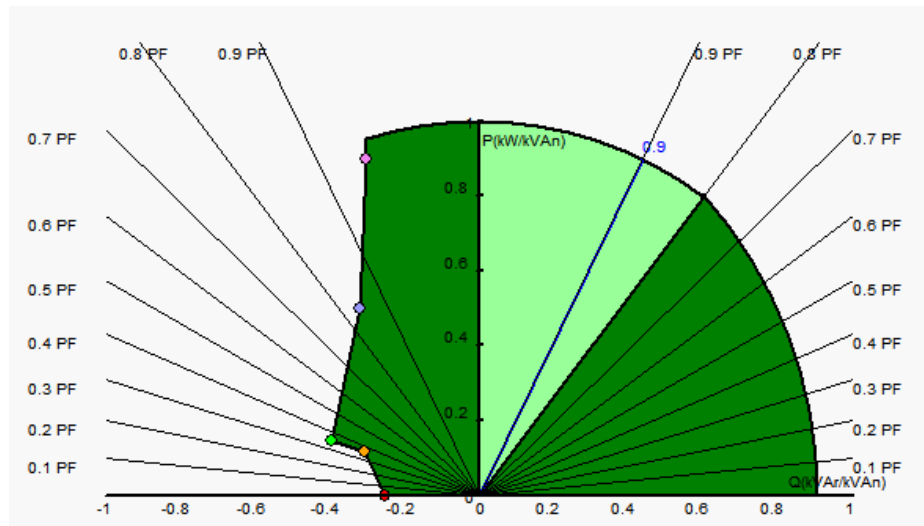

Note: This capability diagram is fictitious because it describes evolution of the power factor at one point of the grid, not at the alternator terminals.

- With a fixed reference, the reference can be adjusted by two inputs (up and down), one pulse corresponding to going up one “step” or down one “step”. Both the inputs the value of the step and the delay need to be fixed, and this adjustment is enabled by setting the selector to “Active”.

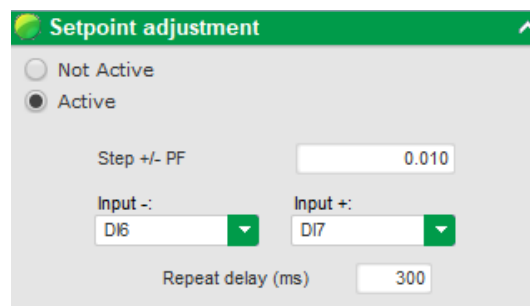

¹³ The minimum and maximum power factor reference terminals can be swapped and the limits reversed: the minimum power factor for 100% of the analog input, and the maximum power factor for 0% of the analog input.

D550

Digital Voltage Regulator

Note: The “+” and -” inputs are the same for all regulation modes.

- **The limits of this reference** should be fixed as required. In the screenshot below they are 1 and 0.8 (supplying reactive power as seen by the generator). The active limits should be those of the alternator to keep the machine in its capability diagram, but also those fixed in this page. In certain conditions, there can be a grid power factor reference limit without actually being at the limit of this reference because the machine power factor reference is active.

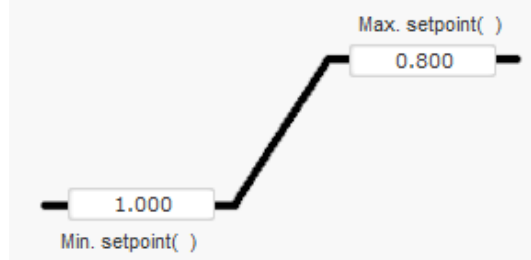

These reference limits define the light green area on the capability diagram in which the reference can vary.

R

P

5.2.8.7. Regulation of the field current (manual mode)

- This regulation is used to control the value of the field current directly. It is mainly used during commissioning or as fallback mode if a measurement is incorrect on the AVR (alternator voltage measurement or alternator current measurement for example).
- It takes priority over all the other regulation modes that might be active.
- To enable field current regulation, select the activation type from the drop-down list. This can be:
 - Controlled by a digital input (DI1 to DI8).
 - Always enabled by selecting “Always active”.
 - If “None” is selected, field current regulation is never enabled or is enabled by a logic gate.

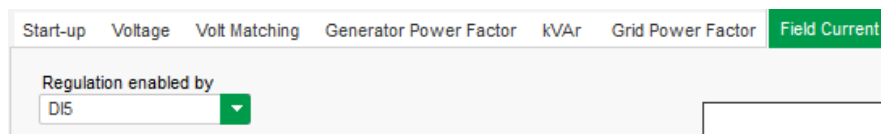

- **The home reference point** is determined either by a fixed value in the “Internal setpoint” tab, or by an analog input, the source, type and range of which need to be set in the “Setpoint from analog input” tab.

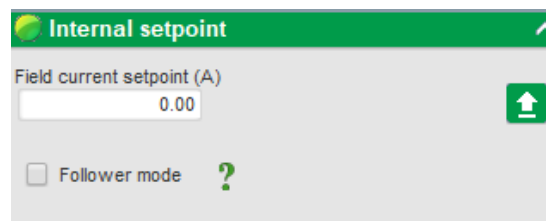

D550

Digital Voltage Regulator

- The “tracking” function, when switching from a regulation mode to manual mode, allows the field current measurement to be used as a reference. This prevents any visible “jumps” of the operating point of the machine. The reference can then be changed using the up and down inputs.

Note: This function is only possible if the home reference point is fixed.

- If the “Analog input” option is selected, the “Reference via analog input” part becomes active. Select the desired analog input box, determine its mode (+/-10 V, 0/10 V, 4-20 mA, potentiometer) and the values at 0% and 100%.¹⁴

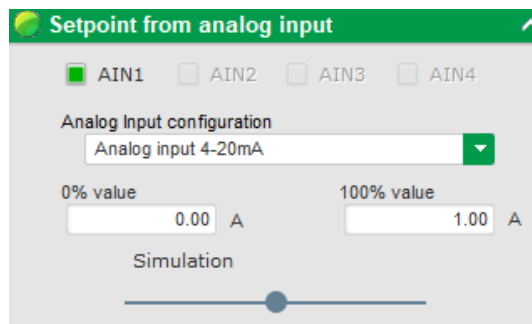

Note: By moving the cursor, it is possible to view the corresponding value of the field current reference (blue line) on the graph located on the right of the shape.

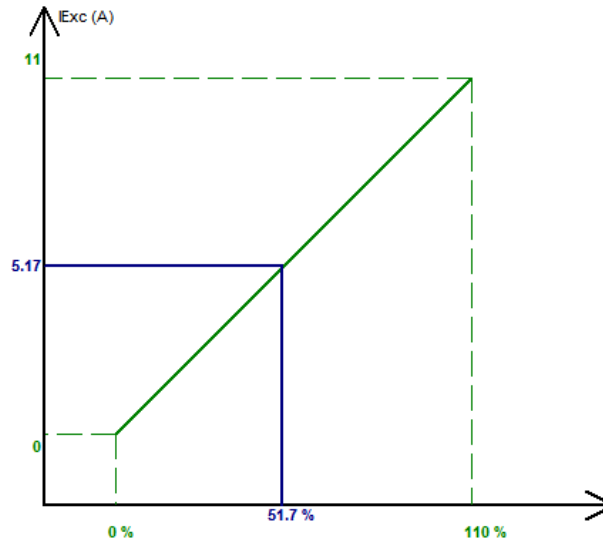

- With a fixed reference, the reference can be adjusted with 2 inputs (up and down), one pulse corresponding to going up one “step” or down one “step”. Both the inputs, the value of the step and the delay need to be fixed, and this adjustment is enabled by setting the selector to “Active”.

¹⁴ The minimum and maximum field current reference terminals can be swapped: the minimum field current limit for 100% of the analog input, and the maximum field current for 0% of the analog input.

D550

Digital Voltage Regulator

Note: The “+” and “-” inputs are the same for all regulation modes.

R P 5.2.9. Setting the PID gains

The quick configuration finishes on this page. If your D550 is connected, it is possible to transfer the configuration to the AVR. If you wish to refine parameters which are not accessible in quick configuration mode, click “Continue configuration in Customized mode”.

	Voltage	Field current
Proportional	9,000	2,000
Integral	90	50
Derivative	800	30
Gain	110	100

- Set the various PID gains. Default values are always given in the fields.

	Voltage	Field current	PF/kVAr	Grid PF
Proportional	7,000	2,100	10	1
Integral	100	60	10	1
Derivative	500	15	0	0
Gain	100	100	100	100

D550

Digital Voltage Regulator

- Regulation loop speed can be modified according to the response time of the generator, between 2.5ms and 20ms by 2.5ms steps. If this value is modified, it will be necessary to adjust PID gains.
- If alternator operation requires various load steps, whether adding and/or shedding (standalone operation or parallel machine operation), it may be a good idea to select the “negative forcing”. This function is used to invert the voltage at the exciter field terminals briefly in order to minimize the time to recover the rated voltage to the rated voltage.

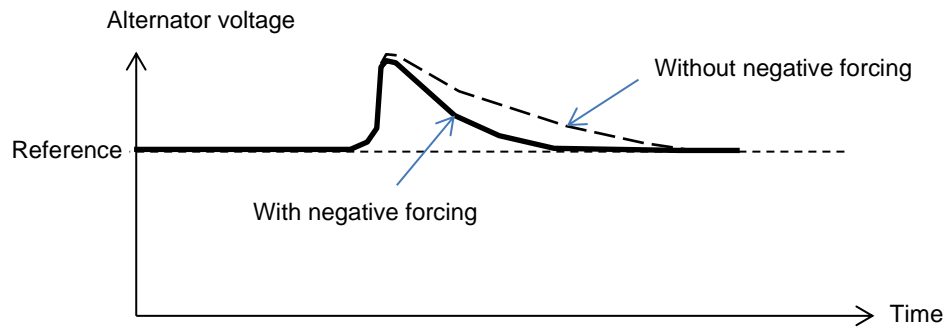

- If a shunt or AREP type field is being used, the power supply voltage depends directly on the voltage at the alternator terminals. As a result, it can fluctuate with the load and therefore influence the PID's behavior. To compensate these fluctuations, it may be advisable to activate the “VBus compensation” function. Below is an example of ramp starting with and without compensation in the case of a shunt excitation:

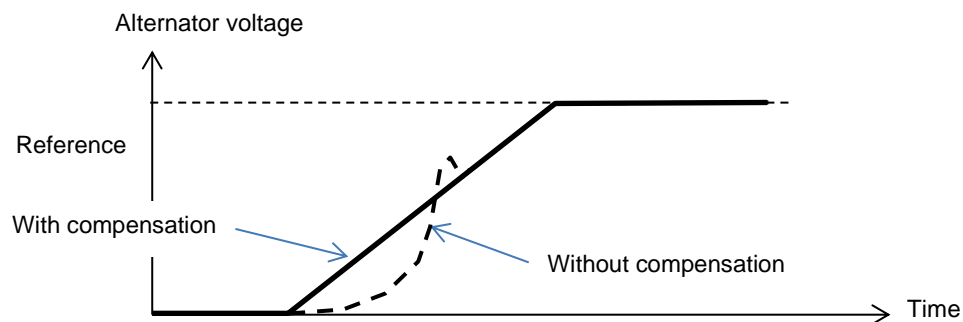

- Click on the “Next” button.

P 5.2.10. I/O management

- Additional inputs can be configured on top of those used in the regulation configuration pages (which are already shown greyed out).
- **The analog inputs/outputs** can be configured by defining the source, the configuration and the 0% and 100% values.

Analog Inputs/Outputs									
ID	Configuration AI	Destination	0% value	100% value	Source	Configuration AO	0% value	100% value	
AIO1	4-20mA	None	0.00	0.00	None	None	0	0	
AIO2	0-10V	None	0.00	0.00	None	None	0	0	
AIO3	0-10V	None	0.00	0.00	None	None	0	0	
AIO4	0-10V	None	0.00	0.00	None	None	0	0	

D550

Digital Voltage Regulator

- **The digital outputs/inputs** can be configured by defining the source, the activation (active low= closed if the condition is fulfilled, “active high” = output open if the condition is fulfilled). The configured type is shown in the picture on the right of the screen (relay or transistor).

The screenshot displays two configuration tables for the D550 Digital Voltage Regulator. The left table, titled "Digital Inputs", lists 8 digital inputs (DI1 to DI8) with "Active" status set to "Active Low" and "Destination" set to "None". The right table, titled "Digital Outputs", lists 8 digital outputs (DO1 to DO8) with "Source" set to "None" and "Active" status set to "Active Low". Below the DO1-DO8 entries, there are two rows for relays (RL1 and RL2) with "Source" set to "None" and "Active" status set to "Active Low". To the right of the DO1-DO8 entries, there is a schematic diagram of a transistor output labeled "OUT". Below the RL1 and RL2 entries, there is a schematic diagram of a relay output labeled "OUT".

P 5.2.11. Curve functions

5.2.11.1. Overview

Curve functions are used to control a parameter as a function of another parameter. For example:

- The kVAr reference as a function of the voltage during kVAr regulation
- The maximum stator current as a function of the stator temperature
- The maximum field current as a function of the temperature or an analog input
- The voltage reference as a function of the speed
- The field current as a function of the active power
- Specific scaling
- Etc.

Curve functions can be created.

For the curve function to work, the X and Y axis parameters need to be defined, as well as 5 points. These functions are active as soon as the curve is created.

The curve fields can be reset by clicking on the “Reset” button of each curve.

The screenshot shows the configuration interface for a curve function. It features a grid for defining 5 points. The X-axis is labeled "X axis | None" and the Y-axis is labeled "Y axis | None". A "Reset" button is visible. The grid contains the following data:

Point	X value	Y value
Point 1	0.00	0.00
Point 2	0.00	0.00
Point 3	0.00	0.00
Point 4	0.00	0.00
Point 5	0.00	0.00

Below the grid, there is a graph area with the label "None=f(None)" and a "0" on the Y-axis.

D550

Digital Voltage Regulator

5.2.11.2. Examples curve functions

- **Reactive power reference as a function of the grid voltage for a 400 V machine.**

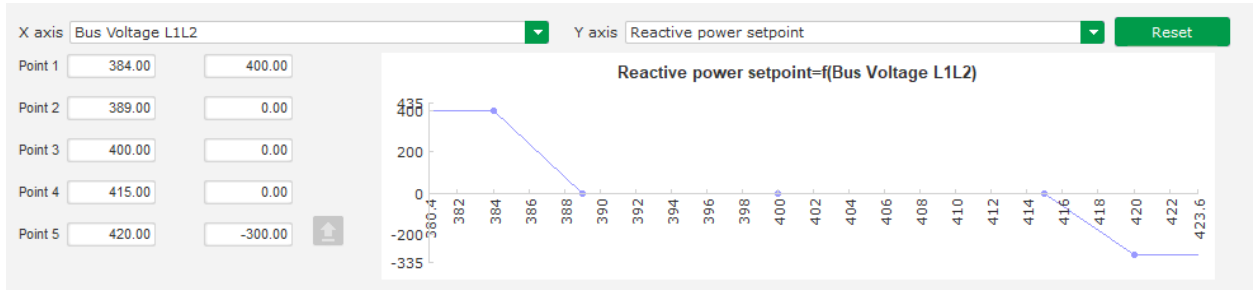

Note: We can see that for a voltage value lower than the one defined at point “1” the power reference is held at the value defined at point “1”. For a voltage value higher than the one defined at point “5”, the reactive power reference is held at the value defined at point “5”.

- **Field current reference as a function of the temperature measured at the stator (in our example temperature 1).** For a low temperature, increasing the field current is then authorized.

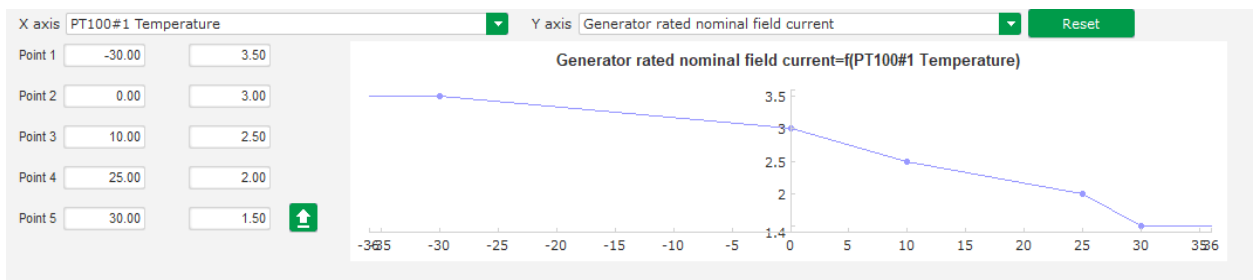

P 5.2.12. User PID gain

This feature allows having an independent PID which can be used to regulate another component.

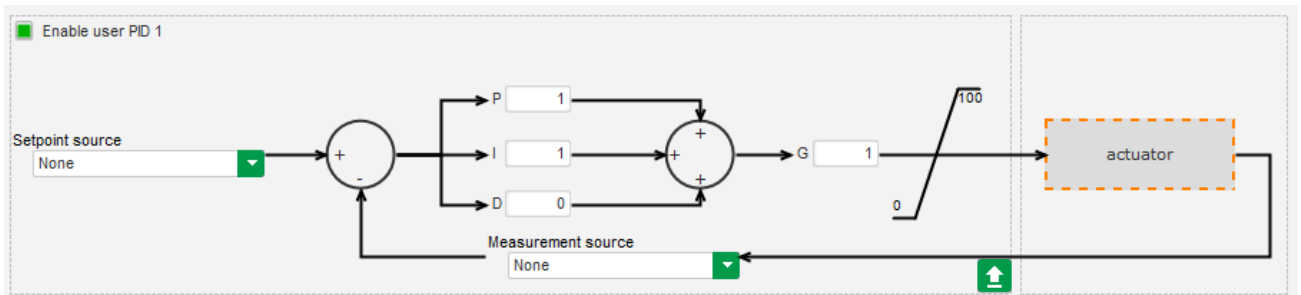

P 5.2.13. Logic/analog gates

5.2.13.1. Overview

Logic and analog gates are used for simple control with one or two inputs and one configurable output by means of drop-down lists.

D550

Digital Voltage Regulator

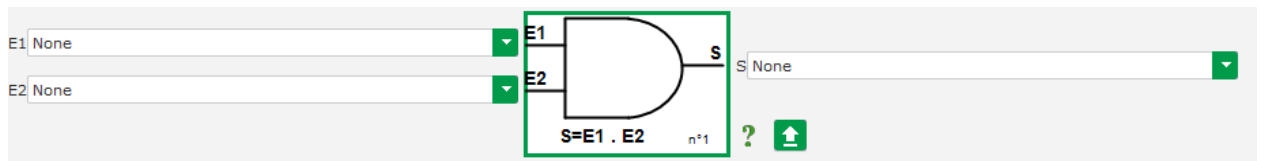

The parameter lists can be enlarged by clicking at the bottom right of the list and holding down until the desired size:

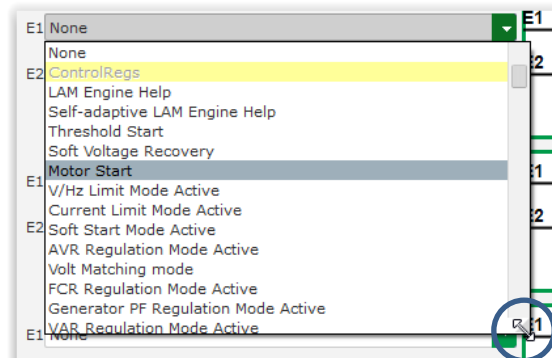

TIP: To select a parameter more quickly, you can enter its first few letters in the drop-down list.

The type of gate can be changed by clicking on the relevant gate. A pop-up menu then appears:

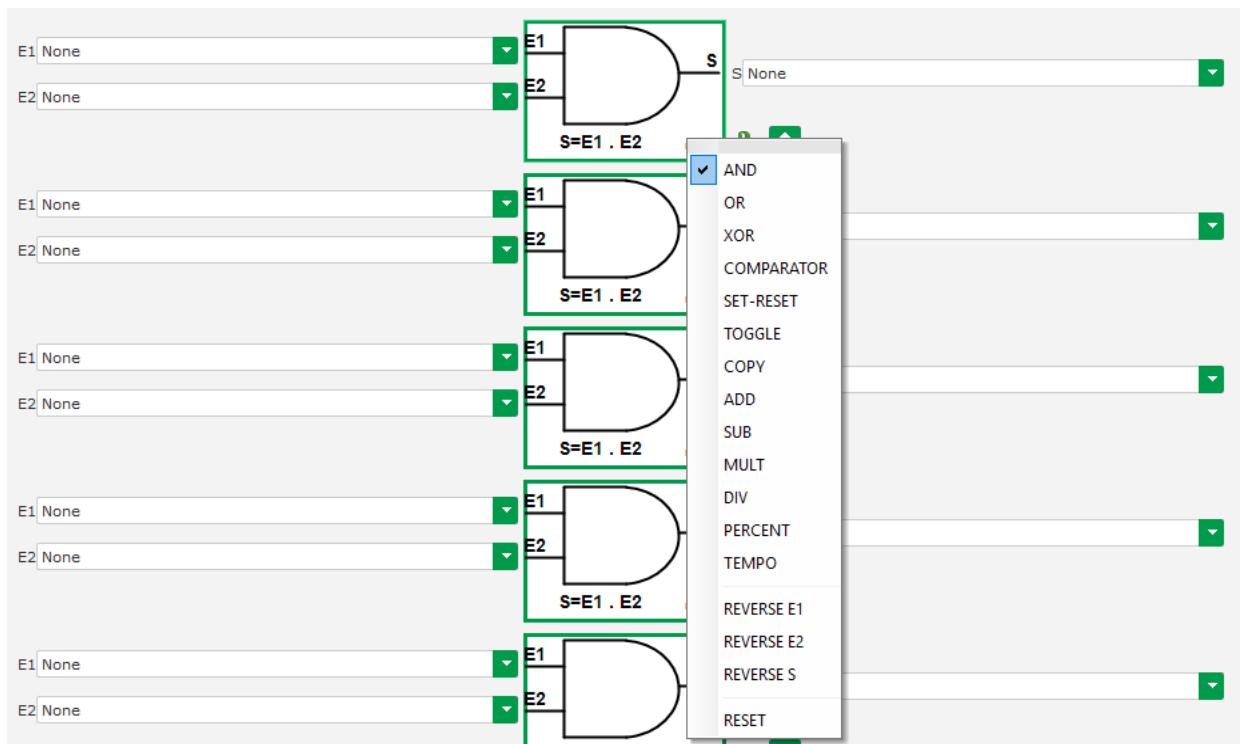

A maximum of 20 gates with 2 inputs can be used.

They can be linked in sequence (using an output gate as an input condition for another gate). Digital “user” variables can be used as a gate input parameter in comparator mode.

D550

Digital Voltage Regulator

The following gates are available:

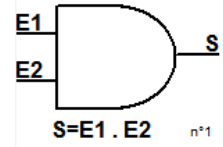
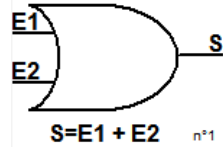
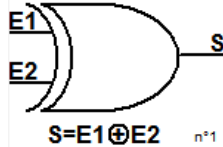
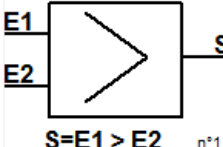
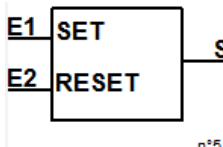
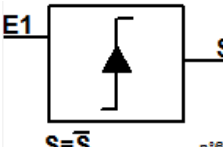
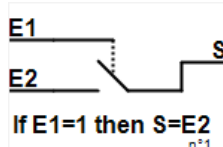
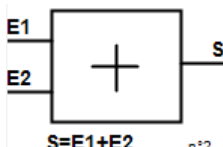
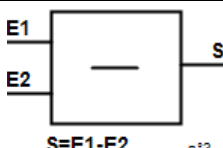
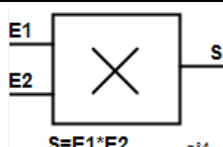
Gate type	Representation	Parameter type	Truth table															
AND	 <p>$S = E1 \cdot E2$ n^*1</p>	Binary	<table border="1"> <thead> <tr> <th>E1</th> <th>E2</th> <th>S</th> </tr> </thead> <tbody> <tr><td>0</td><td>0</td><td>0</td></tr> <tr><td>0</td><td>1</td><td>0</td></tr> <tr><td>1</td><td>0</td><td>0</td></tr> <tr><td>1</td><td>1</td><td>1</td></tr> </tbody> </table>	E1	E2	S	0	0	0	0	1	0	1	0	0	1	1	1
E1	E2	S																
0	0	0																
0	1	0																
1	0	0																
1	1	1																
OR	 <p>$S = E1 + E2$ n^*1</p>	Binary	<table border="1"> <thead> <tr> <th>E1</th> <th>E2</th> <th>S</th> </tr> </thead> <tbody> <tr><td>0</td><td>0</td><td>0</td></tr> <tr><td>0</td><td>1</td><td>1</td></tr> <tr><td>1</td><td>0</td><td>1</td></tr> <tr><td>1</td><td>1</td><td>1</td></tr> </tbody> </table>	E1	E2	S	0	0	0	0	1	1	1	0	1	1	1	1
E1	E2	S																
0	0	0																
0	1	1																
1	0	1																
1	1	1																
Exclusive OR	 <p>$S = E1 \oplus E2$ n^*1</p>	Binary	<table border="1"> <thead> <tr> <th>E1</th> <th>E2</th> <th>S</th> </tr> </thead> <tbody> <tr><td>0</td><td>0</td><td>0</td></tr> <tr><td>0</td><td>1</td><td>1</td></tr> <tr><td>1</td><td>0</td><td>1</td></tr> <tr><td>1</td><td>1</td><td>0</td></tr> </tbody> </table>	E1	E2	S	0	0	0	0	1	1	1	0	1	1	1	0
E1	E2	S																
0	0	0																
0	1	1																
1	0	1																
1	1	0																
COMPARATOR	 <p>$S = E1 > E2$ n^*1</p>	Decimal E1 and E2 Binary O	<table border="1"> <thead> <tr> <th colspan="2"></th> <th>O</th> </tr> </thead> <tbody> <tr><td colspan="2">E1 < E2</td><td>0</td></tr> <tr><td colspan="2">E1 = E2</td><td>0</td></tr> <tr><td colspan="2">E1 > E2</td><td>1</td></tr> </tbody> </table>			O	E1 < E2		0	E1 = E2		0	E1 > E2		1			
		O																
E1 < E2		0																
E1 = E2		0																
E1 > E2		1																
SET-RESET	 <p>n^*5</p>	Binary	<table border="1"> <thead> <tr> <th>E1</th> <th>E2</th> <th>S</th> </tr> </thead> <tbody> <tr><td>0</td><td>0</td><td>S</td></tr> <tr><td>0</td><td>1</td><td>0</td></tr> <tr><td>1</td><td>0</td><td>1</td></tr> <tr><td>1</td><td>1</td><td>O</td></tr> </tbody> </table>	E1	E2	S	0	0	S	0	1	0	1	0	1	1	1	O
E1	E2	S																
0	0	S																
0	1	0																
1	0	1																
1	1	O																
SWITCHING	 <p>$S = \bar{S}$ n^*6</p>	Binary	On the rising edge of I1, S changes state															
COPY	 <p>If E1=1 then S=E2 n^*1</p>	E1 Binary E2 and S Decimal	<table border="1"> <thead> <tr> <th>E1</th> <th>E2</th> <th>S</th> </tr> </thead> <tbody> <tr><td>0</td><td>0</td><td>0</td></tr> <tr><td>0</td><td>E2</td><td>0</td></tr> <tr><td>1</td><td>E2</td><td>E2</td></tr> </tbody> </table>	E1	E2	S	0	0	0	0	E2	0	1	E2	E2			
E1	E2	S																
0	0	0																
0	E2	0																
1	E2	E2																
ADDITION	 <p>$S = E1 + E2$ n^*2</p>	Decimal E1 and E2 S Decimal	$S = E1 + E2$															
SUBTRACTION	 <p>$S = E1 - E2$ n^*3</p>	Decimal E1 and E2 S Decimal	$S = E1 - E2$															
MULTIPLICATION	 <p>$S = E1 \cdot E2$ n^*4</p>	Decimal E1 and E2 S Decimal	$S = E1 \times E2$															

D550

Digital Voltage Regulator

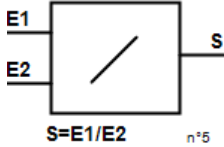
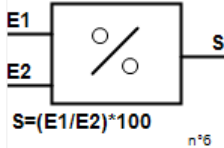
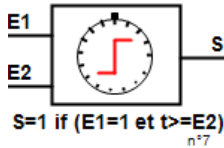
Gate type	Representation	Parameter type	Truth table
DIVISION	 <p>$S = E1 / E2$ n*5</p>	Decimal E1 and E2 S Decimal	$S = E1 / E2$ S value is not changed if E2 is null
PERCENTAGE	 <p>$S = (E1 / E2) * 100$ n*6</p>	Decimal E1 and E2 S Decimal	$S = (E1 / E2) * 100$
TEMPORIZATION	 <p>$S = 1 \text{ if } (E1 = 1 \text{ et } t \geq E2)$ n*7</p>	E1 Binary E2 decimal (in seconds) S Binary	$S = 1 \text{ if } (E1 = 1 \text{ and } t \geq E2)$ $S = 0 \text{ if } E1 = 0 \text{ or } t < E2$

The inputs and the output can be reversed in the case of AND, OR, EXCLUSIVE OR gates, again using the gate pop-up menu. In this case a white circle symbolizes the reversal and the gate equation is updated. Example below with the E1 input reversed on an AND gate:

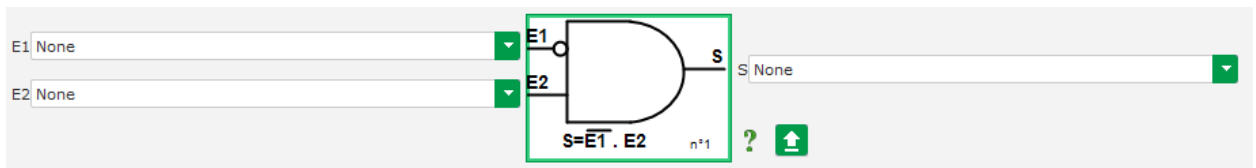

A logic gate's fields can be reset by using the gate pop-up menu and clicking "RESET".

A help is available by clicking on the question mark, which brings up the truth table for the active gate. This is an AND gate¹⁵.

E1	E2	S
0	0	0
0	1	0
1	0	0
1	1	1

5.2.13.2. Examples of gate programming

- **Starting the AVR on power supply voltage threshold:** as soon as the power is switched on, the power supply voltage increases. A threshold should therefore be set above which the ramp will be able to be executed. A user-defined variable is used.

The "COMPARATOR" gate is then chosen with the following variables:

- E1 "Internal power supply Volts"
- E2 "User variable 1", set at 10 (DC bus 10 V)
- S "Starting"

¹⁵ Truth take into account any reversals configured on the gate.

D550

Digital Voltage Regulator

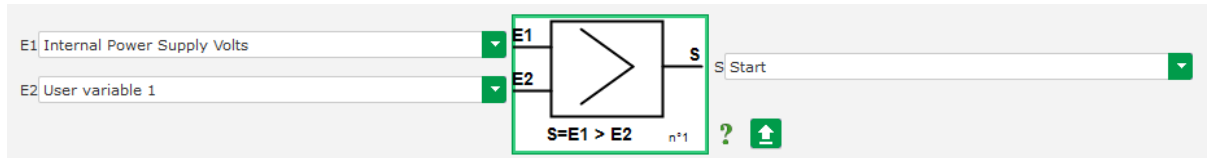

Note: The value of “User variable 1” depends on the voltage your field excitation system can be provided by the residual magnetization. In our example we will put 10 V.

- **VAR regulation for a load less than 10% of the rated power (connected to the grid):** as soon as the machine is connected to the grid, without a load being present, instabilities can appear due to the stator current measurement interference. We therefore recommend kVAR regulation if the active power is less than 10% of the alternator rated power.

The “COMPARATOR” gate is then chosen with the following variables:

- E1 “User variable 2”, set at 10 (10% reactive power)
- E2 “Real power percentage”
- S “VAR regulation”

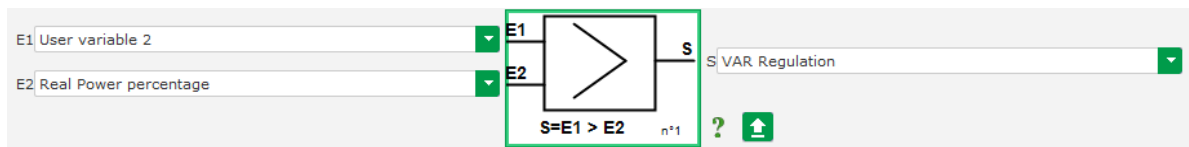

- **Pulsed Starting and Stopping:** The regulation function is switched on by a maintained input. As soon as this input changes state, field excitation is stopped. Pulsed starting and stopping can be configured using a SET-RESET gate:

- E1 “DI1”, which sends the start pulse
- E2 “DI2”, which sends the stop pulse
- S “Starting”

The result is then as follows:

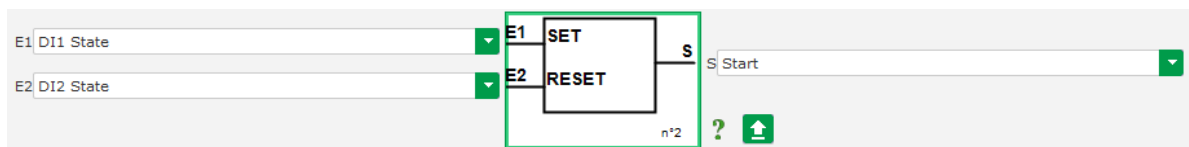

D550

Digital Voltage Regulator

P 5.2.14. Log event

Log event

▼
⏪
⏩
Previous
Next
⏴
⏵

✓

Enabled / Disabled
Event
Event counter
lexc during last loss of sensing fault detected

<input type="checkbox"/>	Enable overvoltage fault detected log	0	0
<input type="checkbox"/>	Enable undervoltage fault detected log	0	0
<input type="checkbox"/>	Enable overfrequency fault detected log	0	0
<input type="checkbox"/>	Enable underfrequency fault detected log	0	0
<input type="checkbox"/>	Enable open diode fault detected log	0	0
<input type="checkbox"/>	Enable short diode fault detected log	0	0
<input type="checkbox"/>	Enable reverse active power fault detected log	0	0
<input type="checkbox"/>	Enable reverse reactive power fault detected log	0	0
<input type="checkbox"/>	Enable PT100 1 alarm detected log	0	0
<input type="checkbox"/>	Enable PT100 1 fault detected log	0	0
<input type="checkbox"/>	Enable PT100 2 alarm detected log	0	0
<input type="checkbox"/>	Enable PT100 2 fault detected log	0	0
<input type="checkbox"/>	Enable PT100 3 alarm detected log	0	0
<input type="checkbox"/>	Enable PT100 3 fault detected log	0	0
<input type="checkbox"/>	Enable PT100 4 alarm detected log	0	0
<input type="checkbox"/>	Enable PT100 4 fault detected log	0	0
<input type="checkbox"/>	Enable PT100 5 alarm detected log	0	0
<input type="checkbox"/>	Enable fault detected log	0	0
<input type="checkbox"/>	Enable CTP 1 fault detected log	0	0
<input type="checkbox"/>	Enable CTP 2 fault detected log	0	0
<input type="checkbox"/>	Enable CTP 3 fault detected log	0	0
<input type="checkbox"/>	Enable CTP 4 fault detected log	0	0
<input type="checkbox"/>	Enable CTP 5 fault detected log	0	0
<input type="checkbox"/>	Enable loss of sensing fault detected log	0	0
<input type="checkbox"/>	Enable unbalanced voltage fault detected log	0	0
<input type="checkbox"/>	Enable unbalanced current fault detected log	0	0
<input type="checkbox"/>	Enable short circuit fault detected log	0	0
<input type="checkbox"/>	Enable IGBT fault detected log	0	0
<input type="checkbox"/>	Enable motor start fault detected log	0	0
<input type="checkbox"/>	Enable power bridge overload fault detected log	0	0
<input type="checkbox"/>	Enable main field overload detected log	0	0
<input type="checkbox"/>	Enable main field overheating detected log	0	0
<input type="checkbox"/>	Enable stator overload detected log	0	0
<input type="checkbox"/>	Enable stator overheating detected log	0	0
<input type="checkbox"/>	Enable battery under voltage detected log	0	0
<input type="checkbox"/>	Enable CAN under voltage detected log	0	0

⬆ Event reset

For each selected event, the corresponding counter will be increased anytime it appears. In case of an event, the excitation current is recorded.

D550

Digital Voltage Regulator

P 5.2.15. Second configuration

This function is usually known as the “50/60Hz switch function”, but it offers much more features and flexibilities and is used to change a maximum of 16 parameters according to the state of a logic input. Note that this second configuration will only be taken into account after restarting the AVR.

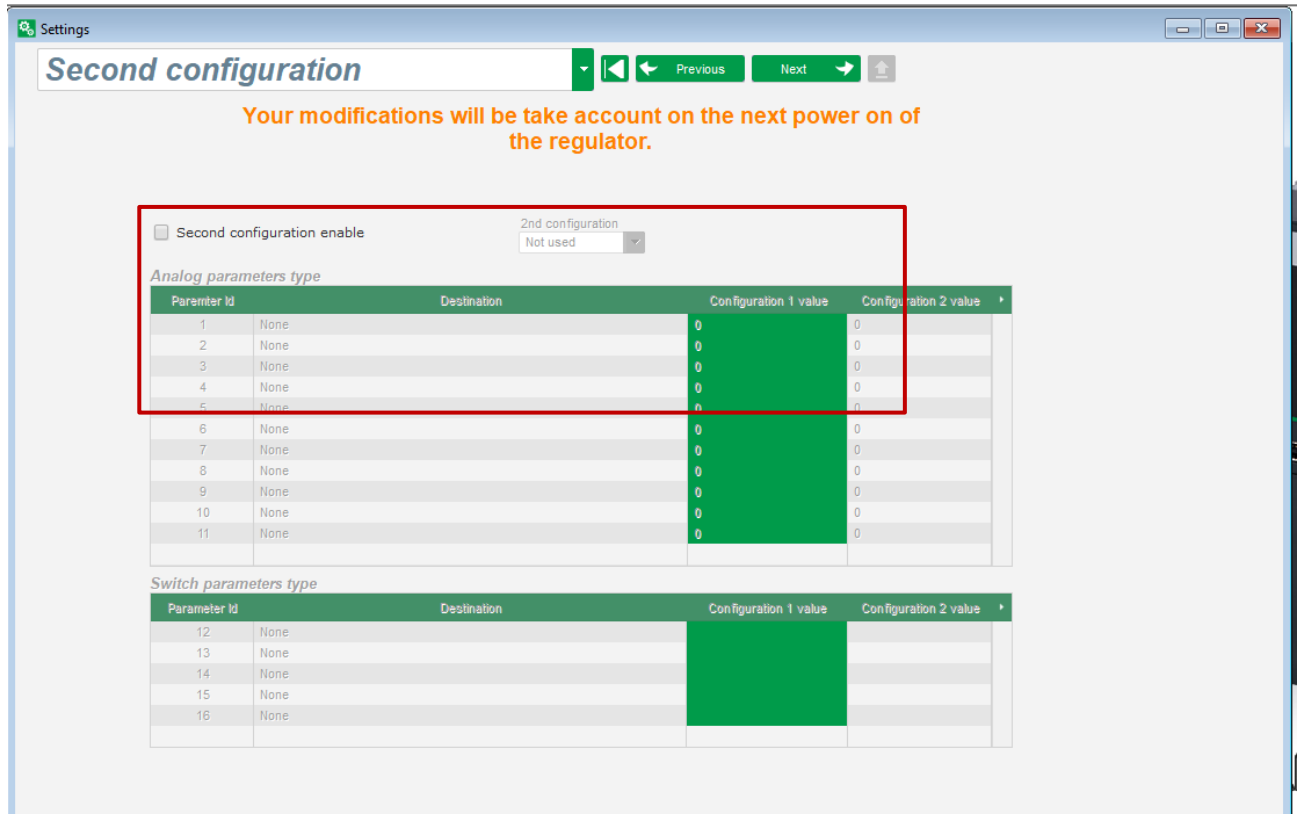

- Choose the activation source of second configuration.

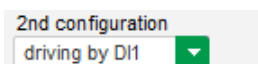

The activation of DI1 leads the switching to the second configuration and its deactivation brings the regulation back to the base configuration.

Reminder: The switch is only taken into account at the regulation starting. Any activation or deactivation when the regulator is in operation will be ignored.

- **Select the parameters** which will be affected when switching to that second configuration. In the example above, we define a new frequency knee at 58Hz, a new voltage setpoint at 480V and the V/Hz slope is set to 1.5.

D550

Digital Voltage Regulator

P 5.2.16. Synchronization

As long as the grid code voltage measurement is wired, the D550 is capable of running the grid synchronization sequence. In this case, check that the phase order is correct since the D550 does not do this.

The frequency, voltage and phase angle ranges must then be set. These must be complied with so that connection can take place without damaging the machine.

The closing time of the circuit breaker between the alternator and the grid must also be configured. This ensures that synchronization can be performed and completed before leaving of the configured connection zone.

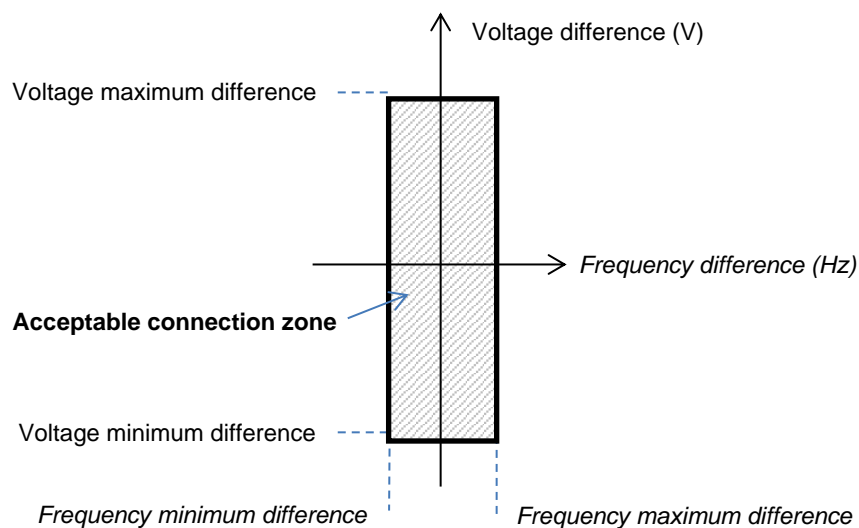
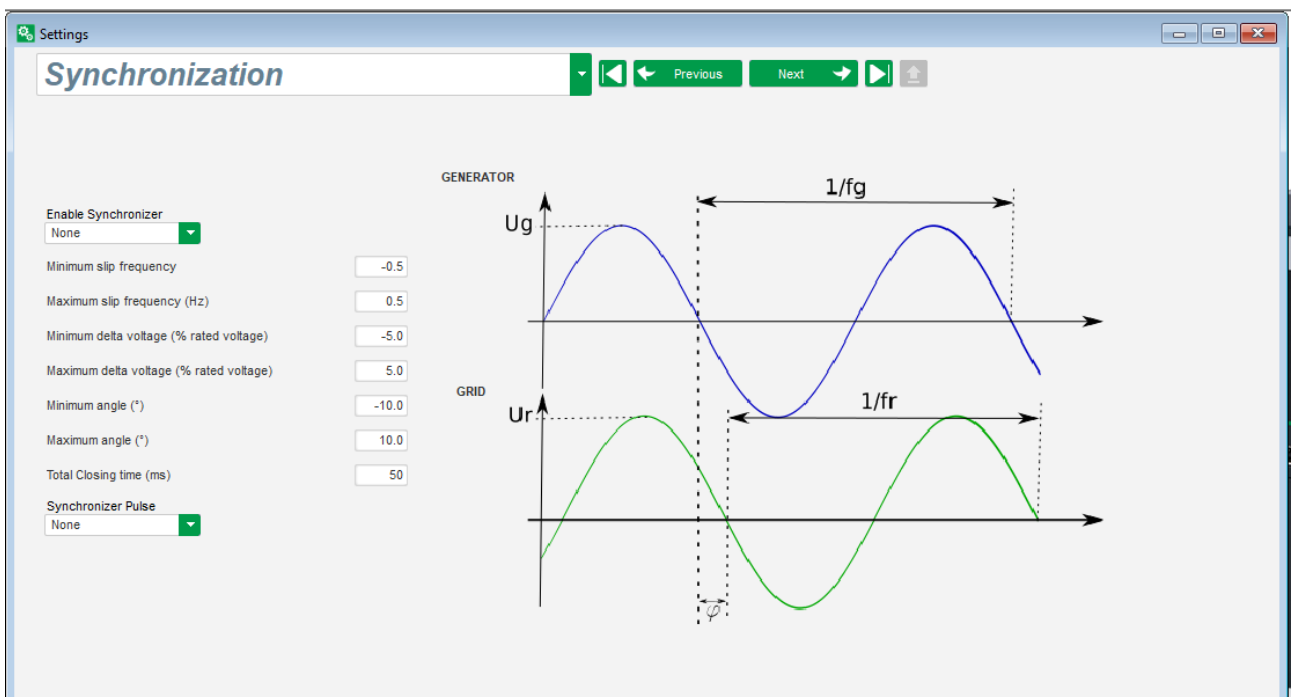

D550

Digital Voltage Regulator

The synchronization sequence is controlled by a logic input or a parameter which is maintained in active mode (controllable via communication or a logic gate).

The possible synchronization pulse remains active as long as the frequency difference and voltage difference are in the range defined by the upper and lower limits. A signal should therefore be provided for closing the grid connection contactor.

The frequency difference can be used to control an analog output to inform the genset controller (or any other control device) that the driving system frequency needs to be increased or decreased. The parameters should be set in the "I/O" page. An example for a frequency difference between -0.5 Hz and +0.5 Hz is given below.

Analog Inputs/Outputs									
ID	Configuration AI	Destination	0% value	100% value	Source	Configuration AO	0% value	100% value	
AI01	4-20mA	None	0.00	0.00	Delta frequency for synchronisation	+/-10V	-0.5	0.5	
AI02	0-10V	None	0.00	0.00	None	None	0	0	

This corresponds to the following diagram:

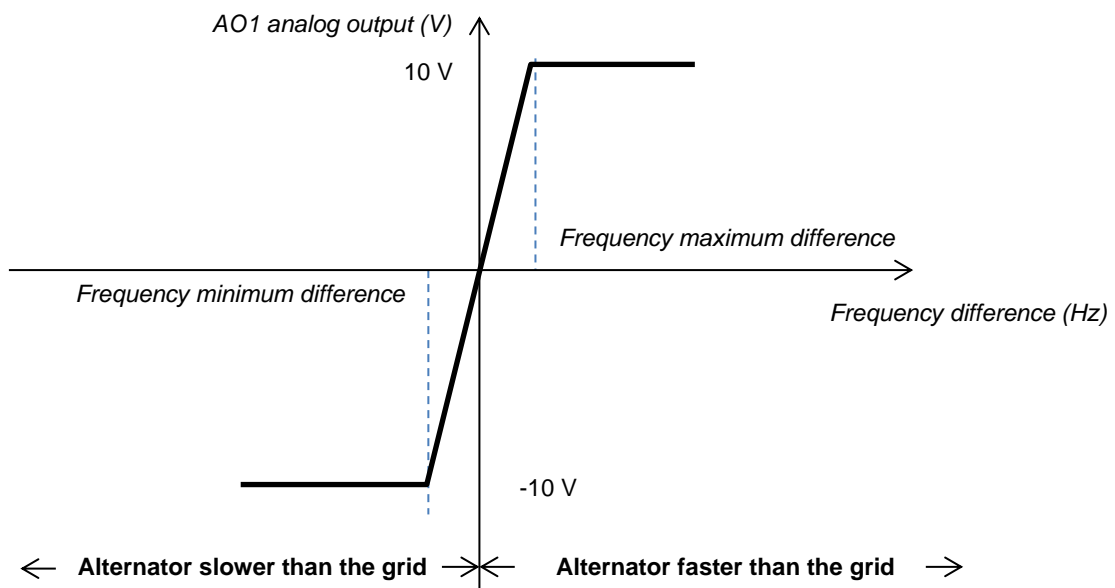

D550

Digital Voltage Regulator

P 5.2.17. Grid code

Grid code function allows activating one or several protections detect faults coming from the grid, as LVRT events (Low Voltage Ride Through) or FRT (Fault Ride Through). These events can damage the generator. 4 independent functions are embedded in the D550:

- Voltage support for detecting grid code faults
- Grid code profile monitoring
- Pole slipping monitoring
- Maximum stator current monitoring

It allows saving some parameters as well, as for example generator voltage measures, generator current measures or internal angles.

This function is available when the option coder is mounted d and Easy Log module is wired.

5.2.17.1. Voltage support

This device is activated by selecting “Enable voltage support in PF mode”. A delay before switching to voltage mode can be configured (in ms), as well as the voltage difference in percentage of the rated grid voltage and the voltage difference in percentage of the rated grid voltage.

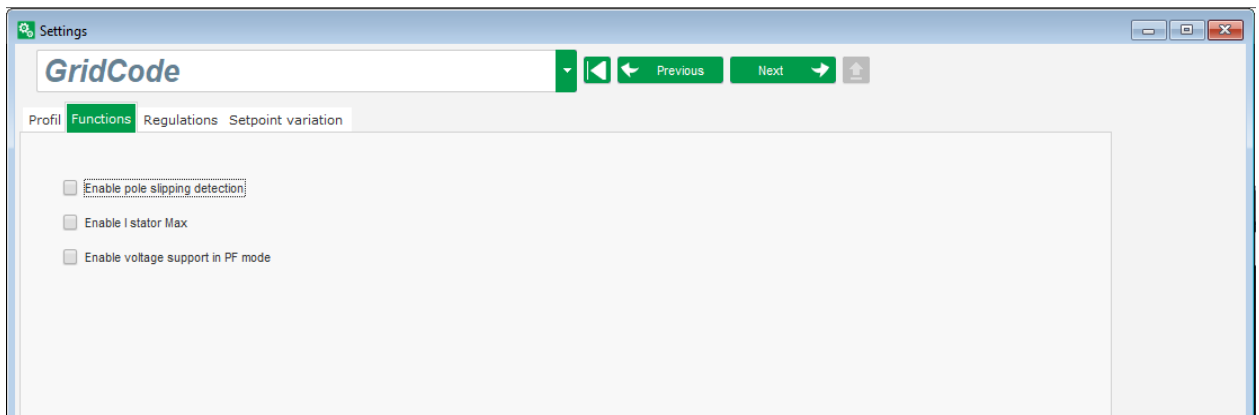

These parameters allow the D550 to force the voltage regulation mode to support the grid by absorbing the reactive power limited by the configured PQ profile (capability curve) or by generating reactive power (with possible limitation) if the voltage measured at the alternator terminals is outside the defined range. In the example below, there is a 10% difference:

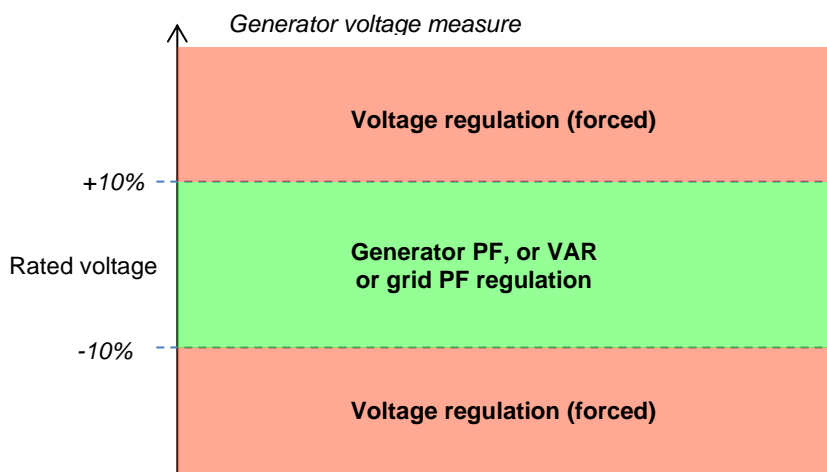

D550

Digital Voltage Regulator

Status of this support can be affected to a logical output or used in logical functions. Below an example with this fault addressed on output DO2 in "Inputs/Outputs page".

Digital Outputs		
Source	Active	Digital Output
None	Active Low	DO1
Voltage monitoring state	Active Low	DO2

5.2.17.2. Grid code profile monitoring

This function is activated by selecting "Enable grid code profile monitoring". It's also imperative to fill in values of the profile, imposed by the grid code standard applied in the location where the D550 is implemented. It allows monitoring that generator voltage is always at least greater or equal to the value given in the profile, as soon as the grid code event is started. If the voltage is lower than the value determined by the profile, the fault flag is activated.

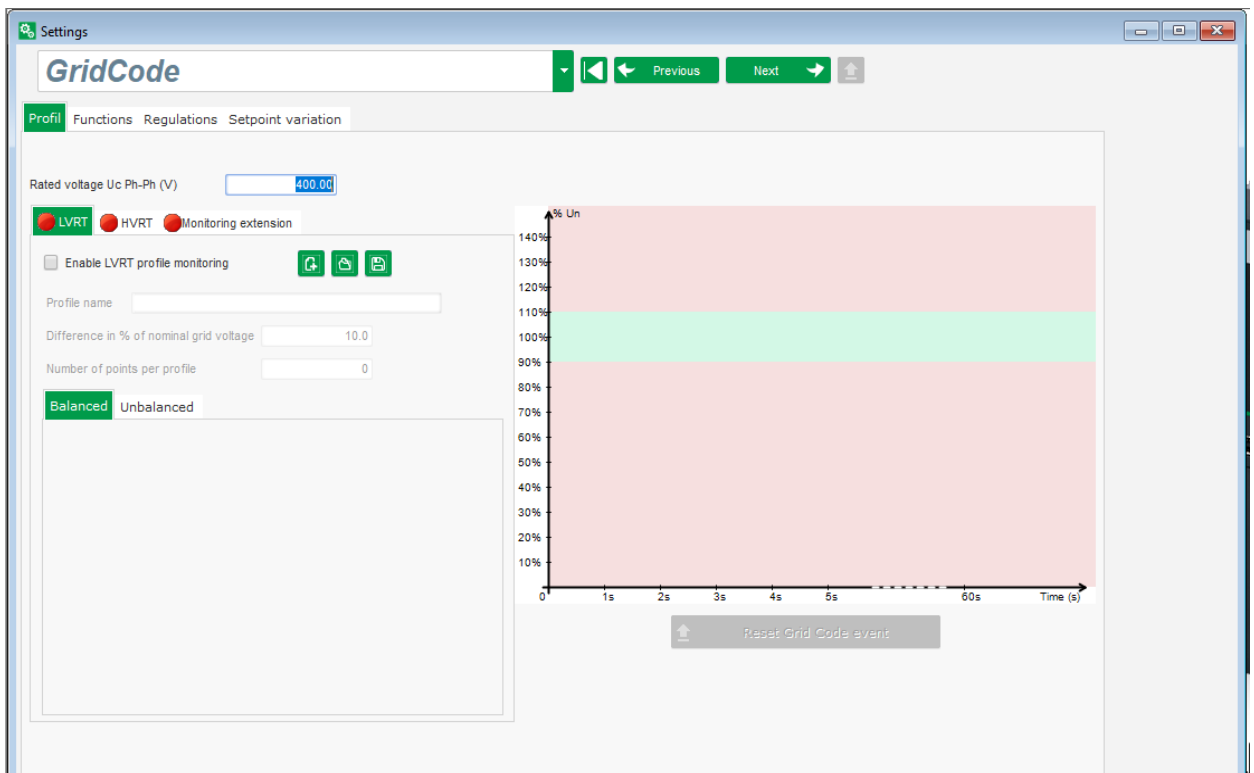

The status of this monitoring can be affected to a logical output or used in a logical function. Below an example with this fault addressed on DO2 in "Inputs/outputs" page.

Digital Outputs		
Source	Active	Digital Output
None	Active Low	DO1
State of grid code profile monitoring	Active Low	DO2
None	Active Low	DO3

D550

Digital Voltage Regulator

5.2.17.3. Stator current monitoring

This protection is activated by selecting “Enable I stator Max” and giving values for maximum current that the generator can withstand (in times of rated stator current). Such an over current can occur when the grid recovers after a grid code fault, if the difference between angular position of the rotor and electric angle is too high.

The measure of overcurrent is realized with a dedicated CT connected on “Grid code” CT input. Values for the primary and the secondary have to be set in “Wiring” page. Hereunder is an example with a coefficient set at “2”.

Enable I stator Max

I stator maximum coeff

Note: As the overcurrent is very fast, the fault status won't be an auto reset fault.

The overcurrent status can be affected to an output or used in a logical function. Below, an example with this fault affected on DO2 in “Inputs/outputs”.

Digital Outputs		
Source	Active	Digital Output
None	Active Low	DO1
Max I stator detection state	Active Low	DO2
None	Active Low	DO3

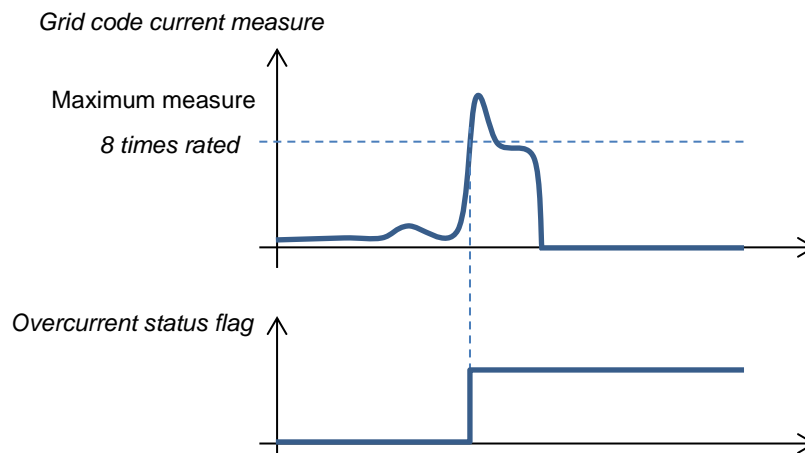

5.2.17.4. Pole slipping monitoring

This detection is only possible if an encoder is installed and wired to the encoder input on the EasyLog PS option connected to the D550.

This function is activated by selecting “Enable pole slipping detection” and giving values for the different parameters:

- Alert angle value (in degrees)
- Maximum angle (in degrees)
- Encoder resolution (in points)
- Encoder offset
- Number of generator pole pairs

D550

Digital Voltage Regulator

The internal angle monitoring, when grid voltage is significantly reduced or lost, controls that the generator internal angle does not exceed a defined value. Indeed, if the internal angle is shifted, when the grid reappears, important mechanical and electrical damages can occur, and can lead to destruction of some elements in the generator.

An auto-calibration function for pole slipping is also possible.

Enable pole slipping detection

Value alert angle	<input type="text" value="20"/>	Encoder offset	<input type="text" value="0"/>	<input type="button" value="Pole Slipping Auto Calibration"/>	<input type="button" value="Reset pole slipping event"/>
Value maximum angle	<input type="text" value="40"/>	Pole pair	<input type="text" value="2"/>		
Encoder resolution	<input type="text" value="1,024"/>				

The pole slipping status can be affected to an output or used in a logical function.

5.3. Comparison window

This window is available by clicking on the button in the home page banner:



The “Comparison” is used to:

- **Compare the D550 configuration with a file**
 - Click on the file 1 “...” button to select the configuration file.

Run the comparison between the AVR and the file:

File 1

File 2

- Click on the “Run the comparison between the AVR and the file” button.
- The modified parameters appear in the list below.

Parameter Number ρ^*	Parameter name	ρ^*	Open file value	ρ^*	AVR Value	ρ^*	Unit	ρ
002.008	Cross Current Enable	Active			Not active			
002.010	Stator current Limit Enable	Active			Not active			
002.017	LAM Engine Help	Enabled			Not enabled			
002.020	Soft Voltage Recovery	Enabled			Not enabled			
003.001	Voltage regulation proportional gain	7000			9000			
003.002	Voltage regulation integral gain	100			120			

- **Compare two configuration files**
 - Click on the file 1 “...” button to select the first configuration file.
 - Click on the file 2 “...” button to select the second configuration file.
 - Click on the “Compare” button on the right.

Run the comparison between the AVR and the file:

File 1

File 2

- The modified parameters appear in the list.

D550

Digital Voltage Regulator

5.4. Print reports

To obtain a of the configuration as a report is possible using “Print” button (this one is active only if settings page is open). This report indicates configuration data of the regulator. A form is opened and this report can be printed or/and exported in another format.

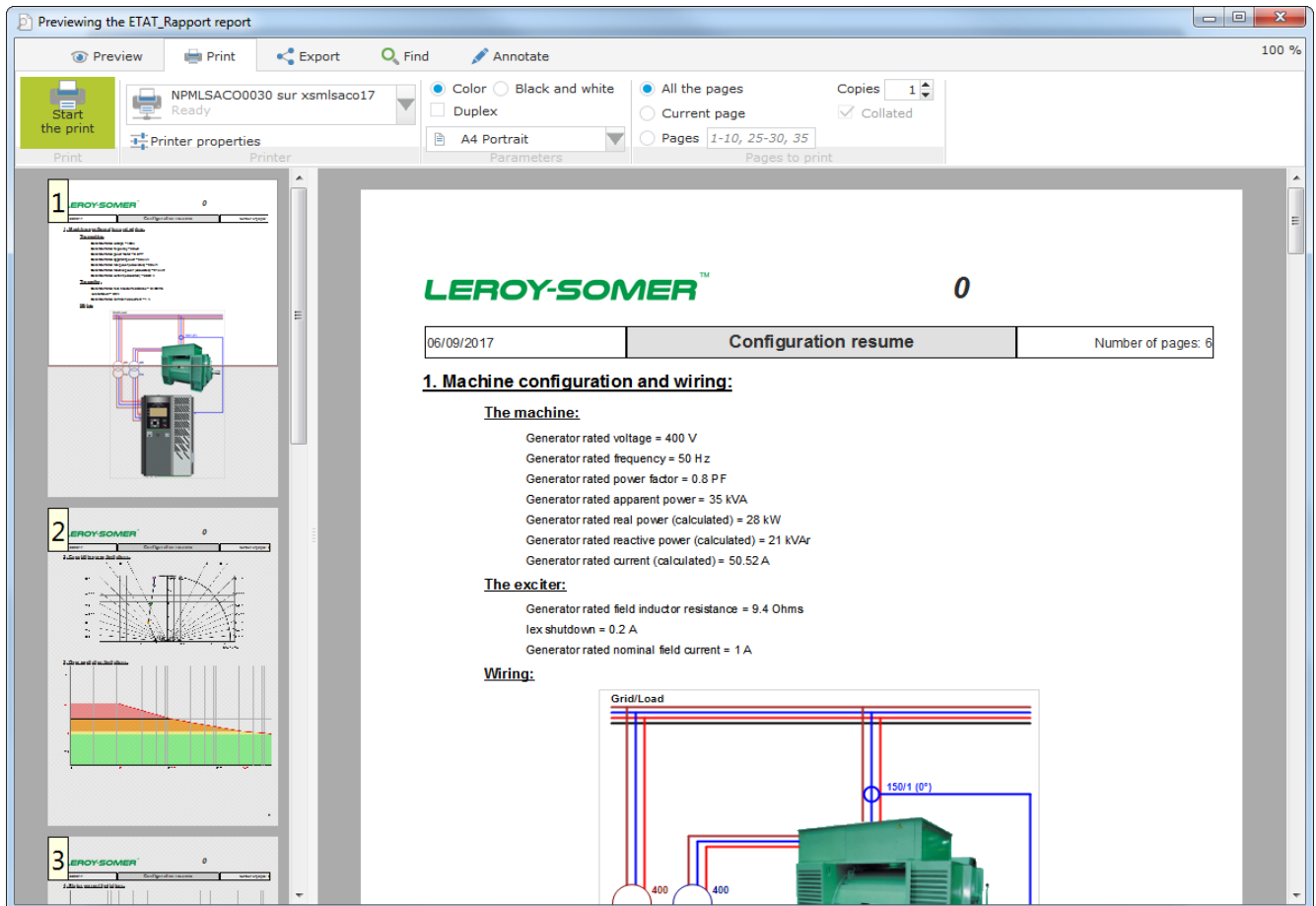

5.5. Excel Export

Configuration can be exported as an excel file by a click on the Save button arrow:

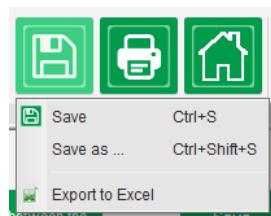

The file created contains each parameter with:

- Identifier (Id)
- Parameter name
- Minimum value
- Maximum value
- Value

D550

Digital Voltage Regulator

- Default value
- Unit
- CAN address
- Value type

Values in grey are “read only” access, others are in read/write.

A	B	C	D	E	F	G	H	I
Id	Parameter name	Minimum value	Maximum value	Value	Initial value	Unit	CAN Address	Type
000.000	Menu0						000.000	INT16
001.000	SystemData						001.000	INT16
001.001	Voltage UN	0	100000	0	0	V	001.001	FLOAT32
001.002	Voltage VN	0	100000	0	0	V	001.002	FLOAT32
001.003	Voltage WN	0	100000	0	0	V	001.003	FLOAT32
001.004	Voltage UV	0	100000	0	0	V	001.004	FLOAT32
001.005	Voltage VW	0	100000	0	0	V	001.005	FLOAT32
001.006	Voltage WU	0	100000	0	0	V	001.006	FLOAT32
001.007	Line Current U	0	10000	0.0	0	A	001.007	FLOAT32
001.008	Line Current V	0	10000	0.0	0	A	001.008	FLOAT32
001.009	Line Current W	0	10000	0.0	0	A	001.009	FLOAT32
001.010	Bus Voltage L1L2	0	100000	0	0	V	001.010	FLOAT32
001.011	Grid Current V	0	10000	0.0	0	A	001.011	FLOAT32
001.012	Real Power KW	0	1000000	0	0	kW	001.012	FLOAT32
001.013	Real Power KW U	0	1000000	0	0	kW	001.013	FLOAT32
001.014	Real Power KW V	0	1000000	0	0	kW	001.014	FLOAT32
001.015	Real Power KW W	0	1000000	0	0	kW	001.015	FLOAT32
001.016	Reactive Power KVAR	0	1000000	0	0	kVAr	001.016	FLOAT32
001.017	Reactive Power KVAR U	0	1000000	0	0	kVAr	001.017	FLOAT32
001.018	Reactive Power KVAR V	0	1000000	0	0	kVAr	001.018	FLOAT32
001.019	Reactive Power KVAR W	0	1000000	0	0	kVAr	001.019	FLOAT32
001.020	Apparent Power KVA	0	1000000	0	0	kVA	001.020	FLOAT32
001.021	Apparent Power KVA U	0	1000000	0	0	kVA	001.021	FLOAT32
001.022	Apparent Power KVA V	0	1000000	0	0	kVA	001.022	FLOAT32
001.023	Apparent Power KVA W	0	1000000	0	0	kVA	001.023	FLOAT32
001.024	Power Factor	-1	1	0.000	0	PF	001.024	FLOAT32
001.025	Power Factor U	-1	1	0.000	0	PF	001.025	FLOAT32
001.026	Power Factor V	-1	1	0.000	0	PF	001.026	FLOAT32
001.027	Power Factor W	-1	1	0.000	0	PF	001.027	FLOAT32
001.028	Frequency Voltage W	0	500	0.0	0	Hz	001.028	FLOAT32
001.029	Field Current	0	1000	0.00	0	A	001.029	FLOAT32
001.030	Field Voltage	0	5000	0.00	0	V	001.030	FLOAT32
001.031	Internal Power Supply Volts	0	500	0.0	0	V	001.031	FLOAT32
001.032	PT100#1 Temperature	-70	500	0.0	0	°C	001.032	FLOAT32
001.033	PT100#2 Temperature	-70	500	0.0	0	°C	001.033	FLOAT32
001.034	PT100#3 Temperature	-70	500	0.0	0	°C	001.034	FLOAT32
001.035	PT100#4 Temperature	-70	500	0.0	0	°C	001.035	FLOAT32
001.036	PT100#5 Temperature	-70	500	0.0	0	°C	001.036	FLOAT32
001.037	PTC 1	100	4700	0	0	ohm	001.037	FLOAT32
001.038	PTC 2	100	4700	0	0	ohm	001.038	FLOAT32
001.039	PTC 3	100	4700	0	0	ohm	001.039	FLOAT32

D550

Digital Voltage Regulator

6. Maintenance instructions

6.1. Warning symbols for maintenance



See section safety [chap 1.4](#).

Preventive maintenance on the D550 AVR should be performed with the alternator stopped, and all power sources switched off and isolated.

6.2. Preventive maintenance instructions

During phases of alternator downtime for preventive maintenance, check that the wires are tight in the connectors (tightening torque between 0.6 Nm and 0.8 Nm), blow dry air through to get rid of any dust that may have settled on and around the D550. Special care should be taken to ensure free circulation of air around the aluminum heatsink at the back of the device.

The D550 has a timer, accessible via parameter 254.008 (parameter 8 of menu 254) (in hours and minutes). Keep an eye on the running time and if this exceeds 40,000 hours, consider changing the AVR.

Note: This timer is only incremented every 10 minutes, and only if the voltage reference is reached.

6.3. Anomalies and incidents

A number of anomalies can occur on the AVR which may lead to its replacement. The main faults are listed in the table below:

ANOMALIES	CAUSES	REMEDIES	RESTARTING
Voltage sensing fault	Alternator sensing VT broken	Replace faulty VT	Stop the alternator and once the faulty VT has been replaced, restart the alternator
	Internal measurement broken	Replace the AVR	Replace the AVR as described in section 6.4
Excitation fault	Faulty component or opening of the field excitation circuit which caused a voltage surge on the transistor	Replace the AVR	Replace the AVR as described in section 6.4
24 Vdc auxiliary supply fault	External supply fault	Replace the 24 Vdc power supply	Stop the alternator and once the faulty power supply has been replaced, restart the alternator
	Voltage converter fault	Replace the AVR	Replace the AVR as described in section 6.4
The AVR is not responding (display frozen, no communication, etc.)	Microcontroller fault	Replace the AVR	Replace the AVR as described in section 6.4

D550

Digital Voltage Regulator

ANOMALIES	CAUSES	REMEDIES	RESTARTING
The regulation mode controlled by an input is not active	Faulty input	Switch control of the regulation mode to another input	Stop the alternator and once the new settings have been entered, restart the alternator
		Replace the AVR	Replace the AVR as described in section 6.4
	The wiring is faulty	Check that the input has been enabled by shunting the 0 V and the local input	Restart the alternator
The field excitation does not start	Faulty starting input	Switch control of starting to another input	Stop the alternator and once the new settings have been entered, restart the alternator
	The AVR power is not switched on	Check the VBus voltage on the HMI	Restart the alternator
	The 24 Vdc power supply is faulty	Check that the AVR is powered up by looking at power LED	Restart the alternator
Regulation of the power factor is unstable	The active power is too low to have a correct power factor measurement	Use kVAr mode for low load regulation (less than 10% of rated load)	Change the AVR settings and restart the alternator
	The stator current measurement is incorrect	Check the CT wiring on the current measurement input and the CT	Restart the alternator
		Replace the AVR if the wiring is correct	Replace the AVR as described in section 6.4

D550

Digital Voltage Regulator

6.4. Replacing a faulty AVR

These operations must be performed by qualified staff. See the warning symbols in [section 2.2](#).

To replace a faulty D550 AVR, proceed as follows:



- Stop the alternator if not already done.
- Switch off and electrically isolate the auxiliary supply and power supply and check that no voltage is present.
- Carefully remove all the AVR connectors, noting their position.
- Undo all the AVR mounting brackets so it can be removed from its position.
- If you do not have the AVR configuration file and the D550 status allows it, import the configuration from the faulty D550 using EasyReg Advanced and a USB cable.
- Still using the PC software, export the retrieved configuration to the new D550 AVR.
- Disconnect the D550 USB stick.
- Fix the new D550 in place of the faulty AVR.
- Reconnect all the connectors on the new AVR.
- Power up the auxiliary supply and check that the AVR is energized
- Start up the alternator drive system.
- Before exciting the alternator, check the alternator voltage measurement and power supply voltage (VBus).
- Switch on the alternator excitation.
- Check all the AVR measurements and regulation modes, and any controlled outputs.

D550

Digital Voltage Regulator

7. Recycling instructions

Nidec Power is committed to minimizing the environmental impacts of its manufacturing operations and of its products throughout their life cycle. To this end, we operate an Environmental Management System (EMS) which is certified to the International Standard ISO 14001.

The automatic voltage regulators manufactured by Nidec Power have the potential to save energy and (through increased machine/process efficiency) reduce raw material consumption and scrap throughout their long working lifetime. In typical applications, these positive environmental effects far outweigh the negative impacts of product manufacture and end-of-life disposal.

Nevertheless, when the products eventually reach the end of their useful life, they must not be discarded but should instead be recycled by a specialist recycler of electronic equipment. Recyclers will find the products easy to dismantle into their major component parts for efficient recycling. Many parts snap together and can be separated without the use of tools, while other parts are secured with conventional fasteners. Virtually all parts of the product are suitable for recycling.

Product packaging is of good quality and can be re-used. Large products are packed in wooden crates; while smaller products come in strong cardboard cartons which themselves have high recycled fiber content. If not re-used, these containers can be recycled. Polythene, used on the protective film and bags for wrapping product, can be recycled in the same way. When you will be preparing to recycle or dispose of any product or packaging, please observe local legislation and best practice.

D550

Digital Voltage Regulator

8. APPENDIX

8.1. Vector permutations

If the alternator rotates in an anti-clockwise direction (non-standard direction of rotation), the following vector permutations can be used to correct the resulting incorrect power and power factor calculations.

It is therefore necessary to modify the D550 wiring. The table below gives the permutations depending on the wiring used.

Alternator direction of rotation (a/c IEC 60034-1)	Alternator voltage measurement			
	AVR terminals	U	V	W
Clockwise	Alternator phases (three-phase measurement)	U	V	W
	Alternator phases (phase/phase single-phase measurement)	-	V	W
	Alternator phases (phase/phase single-phase measurement)	U	-	W
Anti-clockwise	Alternator phases (three-phase measurement)	W	V	U
	Alternator phases (phase/phase single-phase measurement)	-	V	U
	Alternator phases (phase/phase single-phase measurement)	W	-	U

Position of stator current measurement CT	Alternator direction of rotation (a/c IEC 60034-1)	Alternator voltage measurement				Configuration	
		AVR terminals	U	V	W	Current measurement type	Voltage measurement type
Phase U	Clockwise	Three-phase	U	V	W	GEN_U	U-V-W
		Single-phase VW	-	V	W	GEN_U	V-W
		Single-phase UW	U	-	W	GEN_U	U-W
	Anti-clockwise	Three-phase	U	W	V	GEN_U	U-V-W
		Single-phase VW	-	W	V	GEN_U	V-W
		Single-phase UW	W	-	V	GEN_U	U-W
Phase V	Clockwise	Three-phase	U	V	W	GEN_V	U-V-W
		Single-phase VW	-	V	W	GEN_V	V-W
		Single-phase UW	U	-	W	GEN_V	U-W
	Anti-clockwise	Three-phase	W	V	U	GEN_V	U-V-W
		Single-phase VW		V	U	GEN_V	V-W
		Single-phase UW	W		U	GEN_V	U-W

D550

Digital Voltage Regulator

Position of stator current measurement CT	Alternator direction of rotation (a/c IEC 60034-1)	Alternator voltage measurement				Configuration	
		AVR terminals	U	V	W	Current measurement type	Voltage measurement type
Phase W	Clockwise	Three-phase	W	U	V	GEN_U	U-V-W
		Single-phase VW		U	V	GEN_U	V-W
		Single-phase UW	W		V	GEN_U	U-W
	Anti-clockwise	Three-phase	W	V	U	GEN_U	U-V-W
		Single-phase VW		V	U	GEN_U	V-W
		Single-phase UW	W		U	GEN_U	U-W

D550

Digital Voltage Regulator

8.2. AVR regulation mode priority

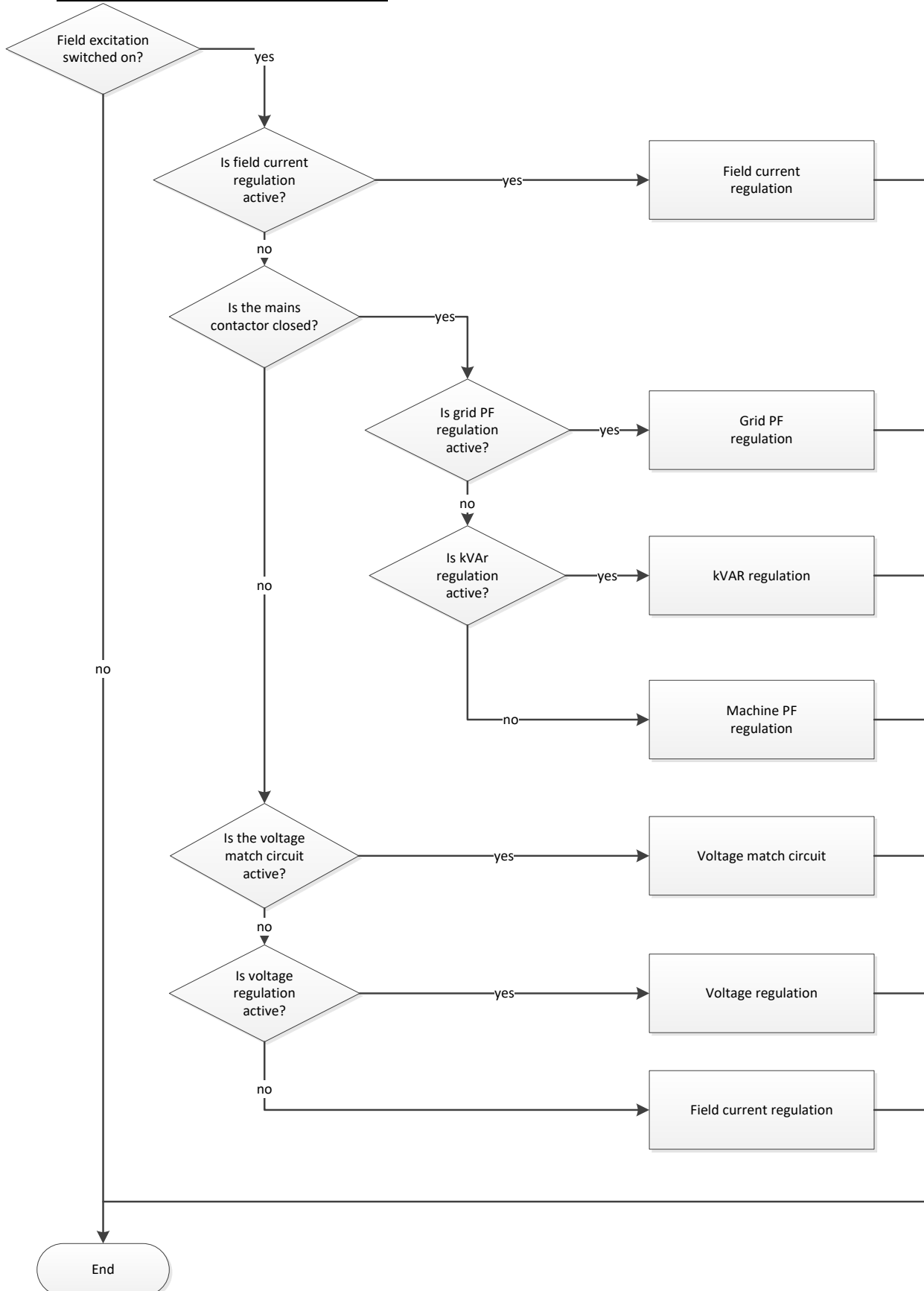

D550

Digital Voltage Regulator

D550

Digital Voltage Regulator

Service & Support

Our worldwide service network of over 80 facilities is at your service. Our local presence is your guarantee for fast and efficient repair, support and maintenance services.

Trust your alternator maintenance and support to electric power generation experts. Our field personnel are 100% qualified and fully trained to operate in all environments and on all machine types.

We have a deep understanding of alternators operations, providing the best value service to optimize your cost of ownership.

How can we help:

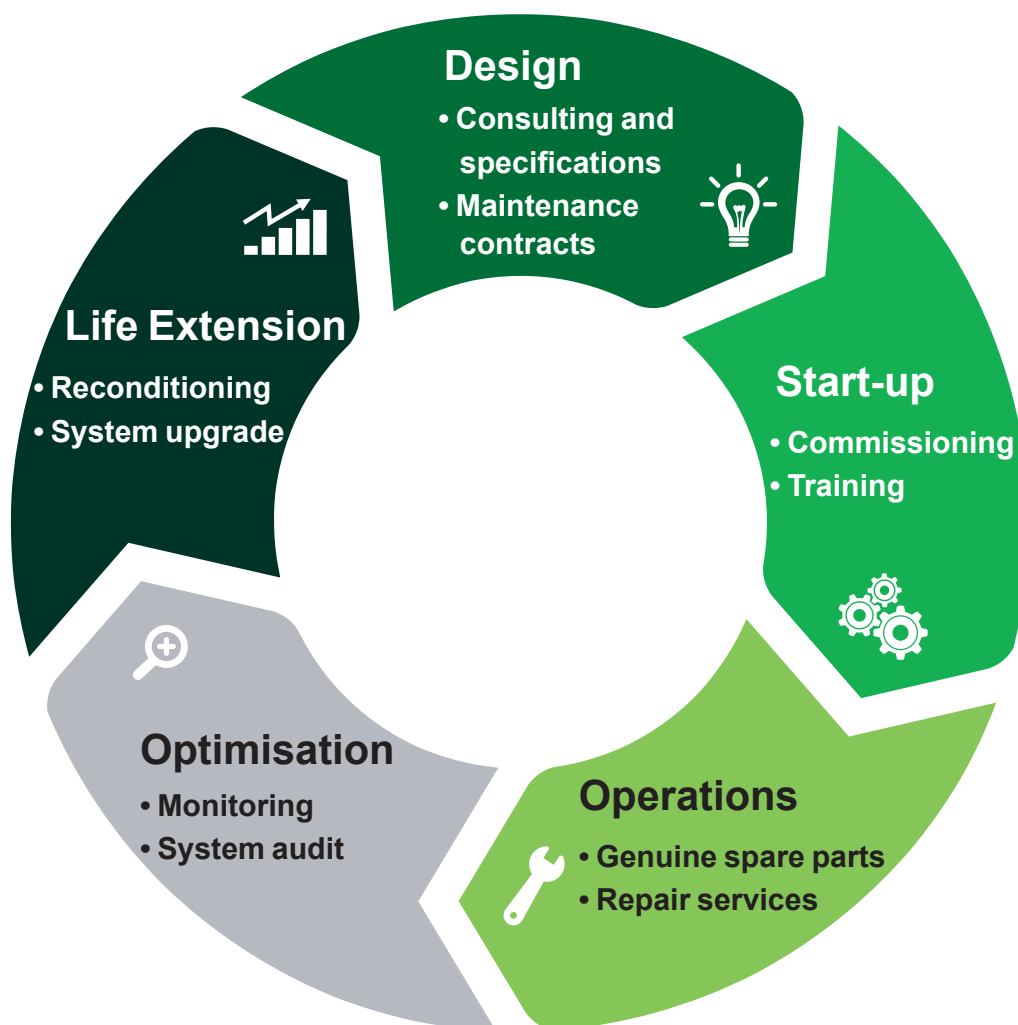

Contact us:

Americas: +1 (507) 625 4011

EMEA: +33 238 609 908

Asia Pacific: +65 6250 8488

China: +86 591 8837 3010

India: +91 806 726 4867



Scan the code or go to:
www.lrsm.co/support

 service.epg@leroy-somer.com

Nidec
All for dreams

www.nidecpower.com

Connect with us at:

