

R449 revision f

AVRs

Installation and maintenance

LEROY-SOMER[™]

Nidec
All for dreams

R449 revision f AVRs

**This manual concerns the alternator AVR which you have just purchased.
We wish to draw your attention to the contents of this maintenance manual.**

SAFETY MEASURES

Before using your machine for the first time, it is important to read the whole of this installation and maintenance manual.

All necessary operations and interventions on this machine must be performed by a qualified technician.

Our technical support service will be pleased to provide any additional information you may require.

The various operations described in this manual are accompanied by recommendations or symbols to alert the user to potential risks of accidents. It is vital that you understand and take notice of the following warning symbols.

WARNING

Warning symbol for an operation capable of damaging or destroying the machine or surrounding equipment.



Warning symbol for general danger to personnel.



Warning symbol for electrical danger to personnel.



All servicing or repair operations performed on the AVR should be undertaken by personnel trained in the commissioning, servicing and maintenance of electrical and mechanical components.



When the generator is driven at a frequency below 28 Hz for more than 30 seconds with an analogue AVR, its AC power supply must be disconnected.

WARNING

This AVR can be incorporated in a EC-marked machine.

This manual is to be given to the end user.

© - We reserve the right to modify the characteristics of this product at any time in order to incorporate the latest technological developments. The information contained in this document may therefore be changed without notice.

This document may not be reproduced in any form without prior authorisation. All brands and models have been registered and patents applied for.

R449 revision f

AVRs

CONTENTS

1 - INTRODUCTION TO THE R449	4
1.1 - Application.....	4
1.2 - Description.....	4
1.3 - Electrical characteristics.....	8
1.4 - Environment.....	11
2 - R726: REGULATION OF POWER FACTOR (2F) AND MAINS SENSING (3F)	12
2.1 - Operating diagram	12
2.2 - Potentiometers.....	13
3 - TYPICAL DIAGRAMS	14
3.1 - AREP 1F LV excitation	14
3.2 - AREP 1F MV excitation	15
3.3 - AREP 3F LV excitation	16
3.4 - AREP 3F MV excitation	17
3.5 - 1F LV shunt + booster excitation	18
3.6 - 1F LV PMG excitation.....	19
4 - COMMISSIONING.....	20
4.1 - In case of standalone regulation.....	20
4.2 - In case of 1F regulation (parallel operation between alternators)	20
4.3 - In case of 2F (power factor regulation) and 3F (voltage match circuit).....	20
5 - TROUBLESHOOTING	22
5.1 - Checking the windings and rotating diodes using a separate excitation	22
5.2 - Static checking of the regulator	22
5.3 - Troubleshooting table	23
5.4 - Replacing the regulator with a spare voltage regulator	25
6 - SPARE PARTS.....	25
6.1 - Designation.....	25
6.2 - Technical support service	25

Disposal and recycling instructions

R449 revision f

AVRs

1 - INTRODUCTION TO THE R449

1.1 - Application

The R449 voltage regulator is of a shunt type. It is designed to fit as standard on A50 to A54 alternators. It can be supplied with power either by a power VT, or by the AREP field excitation system, or by a single-phase or 3-phase PMG. Using the R726 external module, the regulator can control the power factor (2F) and can match the alternator voltage to the mains voltage (3F) prior to synchronisation.

1.2 - Description

The electronic components mounted in a plastic casing are sealed with opaque elastomer. Connection is via 2 connectors (male «Faston» lugs 6.3).

The regulator includes:

- a main terminal strip (10 terminals) J1
 - a secondary terminal block (5 terminals)..... J2
 - a frequency selection terminal block (3 terminals)..... J3
 - a quadrature droop potentiometer..... P1
 - a voltage potentiometer P2
 - a stability potentiometer P3
 - a maximum excitation potentiometer .. P5
 - a sensing selection jumper (single/3-phase with an external module) ST1
 - a response time jumper ST2
 - a frequency selection jumper ST3
 - an external voltage setting jumper ST4
 - a LAM (load adjustment module) jumper ST5
- From R449 Version E number 10,000, this jumper will be removable.
- a selection jumper 13% 25% LAM... ST10
 - bend at 65 Hz (U/F)..... ST11

Two fuses (F1 and F2) are connected to this regulator; they are mounted in the alternator on terminal block C.

Type: gG 10/38 16A 500V.

- ATQ20 (10x38US) 500 VAC UL/CSA

Simplified diagram of a potentiometer: to adjust the potentiometer, check the actual position of the potentiometer stop.

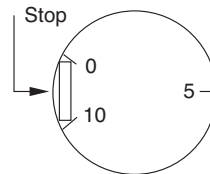

R449 revision f

AVRs

1.2.1 - Power supply connection

1.2.1.1 - AREP system

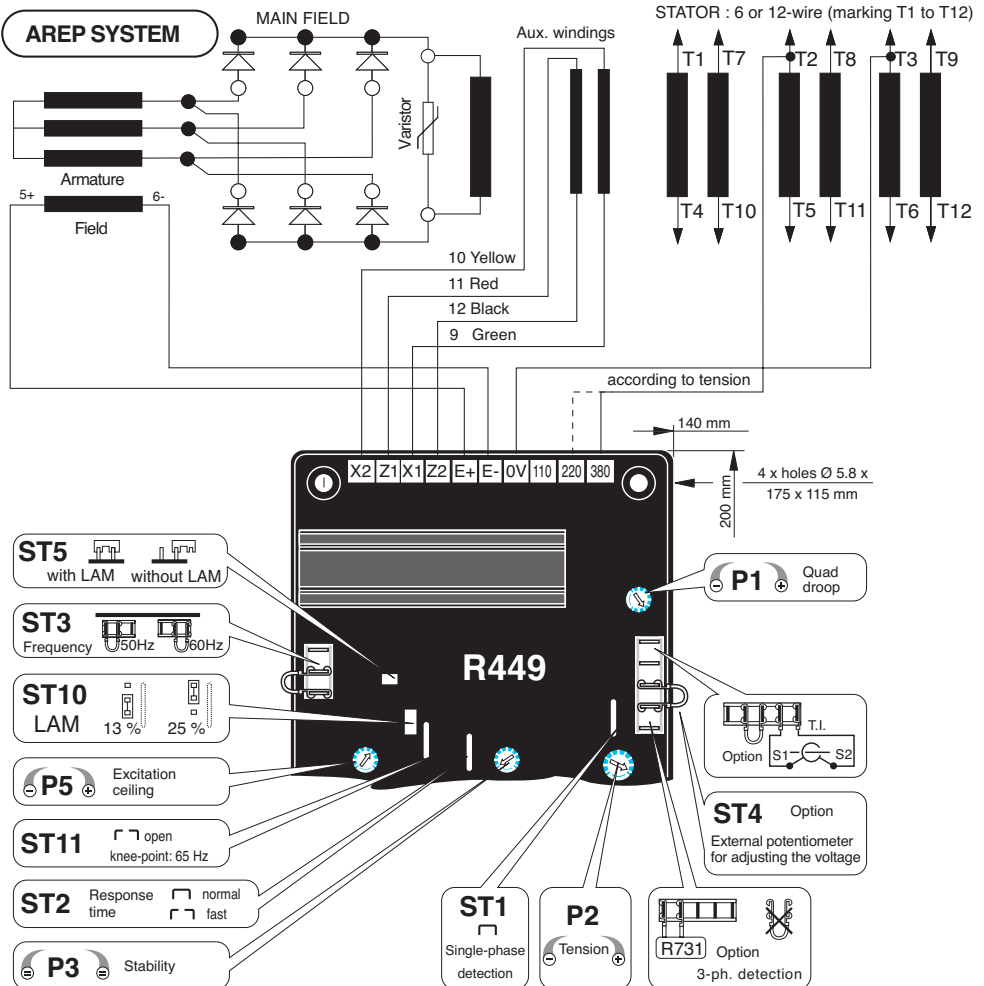

R449 revision f AVRs

1.2.1.2 - PMG system

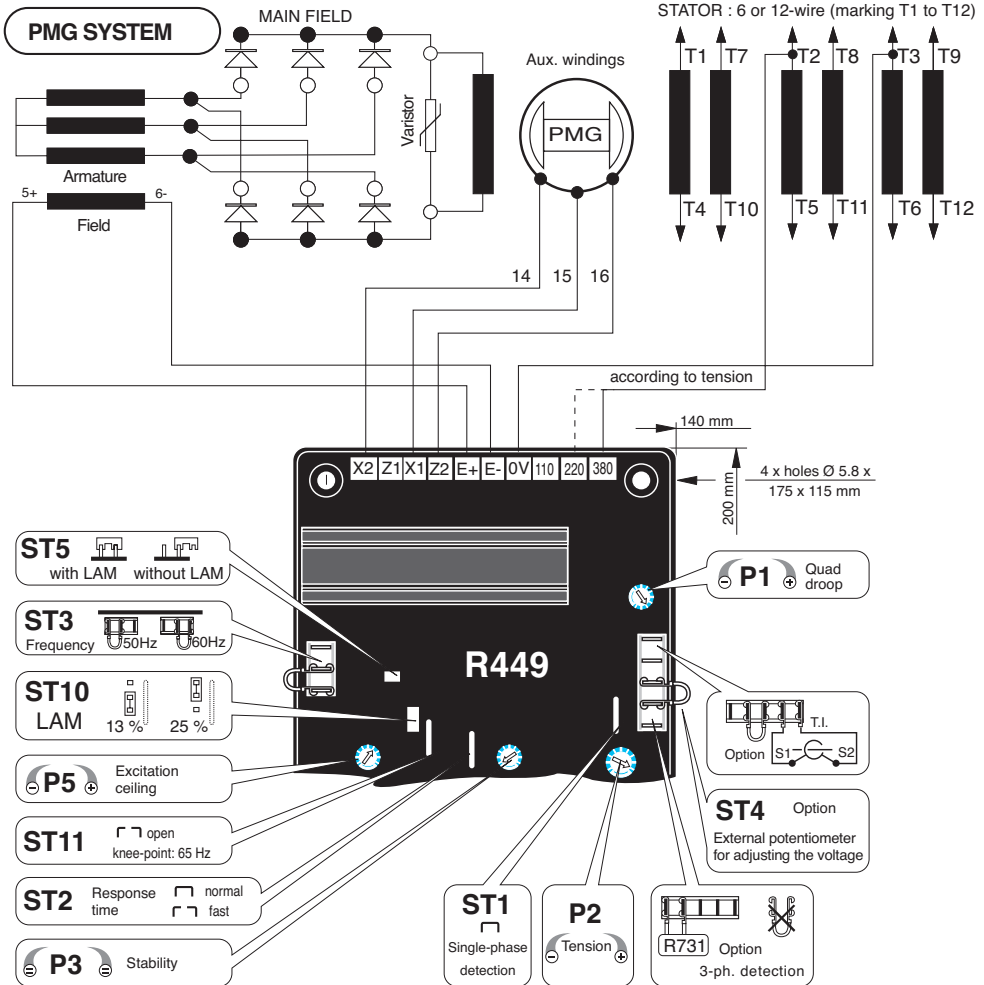

R449 revision f AVRs

1.2.1.3 - SHUNT system

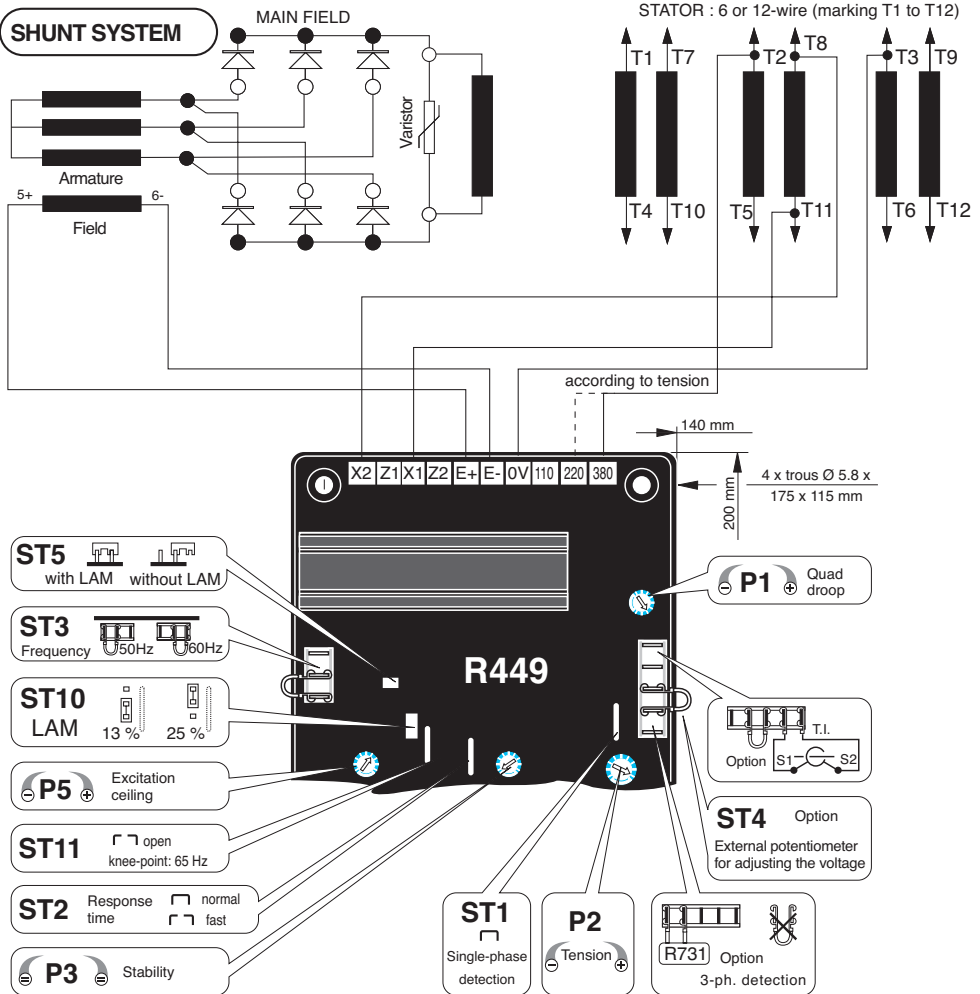

R449 revision f AVRs

1.3 - Electrical characteristics

1.3.1 - Operating diagram

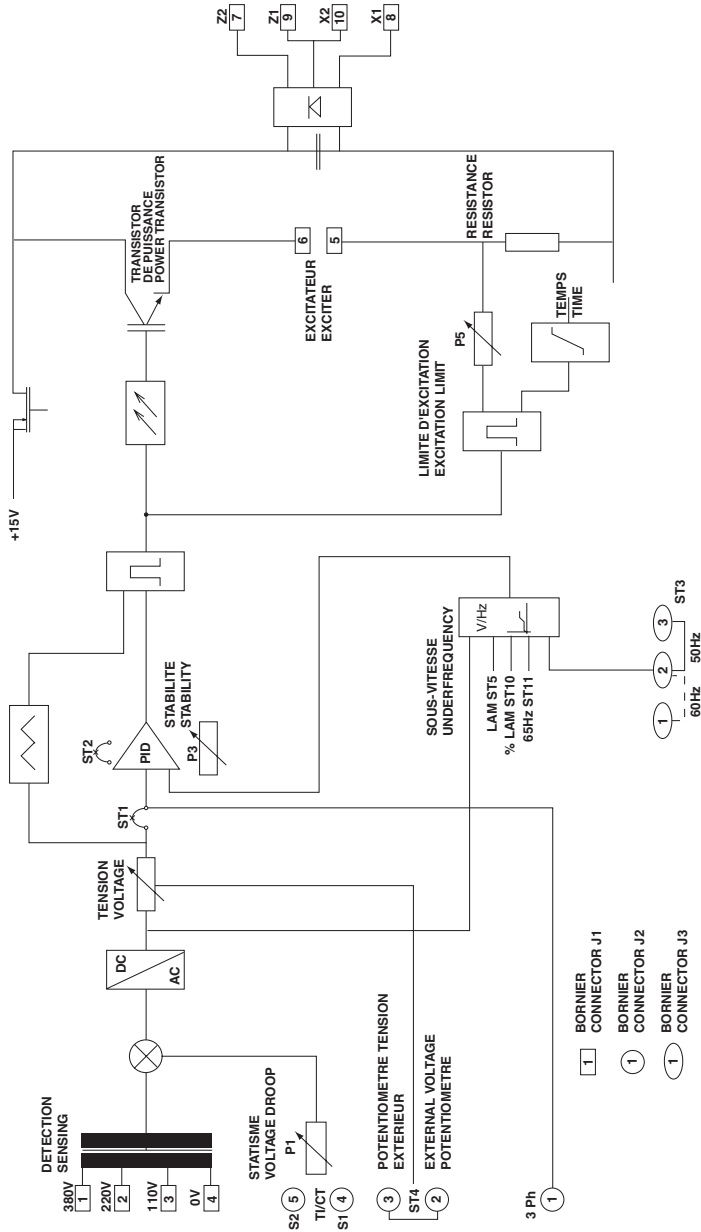

R449 revision f

AVRs

1.3.2 - Detection

The detection is single-phase and is isolated using an internal transformer.

Sensing VA: 5VA

J1 connector, input voltages:

- Terminals 0-110V:
voltage range from 85 to 130V
- Terminals 0-220V:
voltage range from 170 to 260V
- Terminals 0-380V:
voltage range from 340 to 520V

1.3.3 - Voltage accuracy

The voltage accuracy is $\pm 0.5\% U_n$, steady state, linear load.

1.3.4 - Voltage adjustment

The voltage is adjusted either using an internal potentiometer P2, with a voltage range of $\pm 10\% U_n$, or using an external potentiometer (as an option).

The voltage is minimum when internal potentiometer P2 has been rotated fully anti-clockwise.



Connecting the external potentiometer:

- External potentiometer 470 Ω 3W:
voltage range $\pm 5\% U_n$
- External potentiometer 1k Ω 3W:
voltage range $\pm 10\% U_n$

Remove jumper ST4 and connect the external potentiometer as shown in the diagram below. If a regulator is built into the terminal box, remove jumper ST10 from terminal block C and connect the external potentiometer.

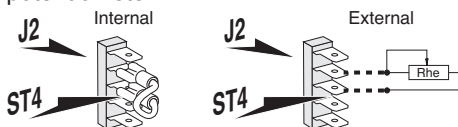

Voltage setting : ST4
A.F. = Internal

1.3.5 - Power supply

The power can be supplied:

- using 2 independent auxiliary windings integrated in the alternator stator (AREP excitation),

- using a single or 3-phase power VT,
- using a single or 3-phase PMG.

The single or 3-phase voltage must not exceed 240V AC.

1.3.6 - Output power

The output power is 7A 63V under normal conditions and 15A for 10s under overload conditions.

1.3.7 - Quadrature droop (1F)

Quadrature droop is achieved using a parallel operation CT (In/1A, 10VA C11).

The voltage droop can be adjusted using potentiometer P1. The voltage range is $5\% U_n$ for Pn PF 0.8.

The quadrature droop is at 0 when potentiometer P1 has been rotated fully anti-clockwise.



1.3.8 - Frequency compared with voltage (without LAM)

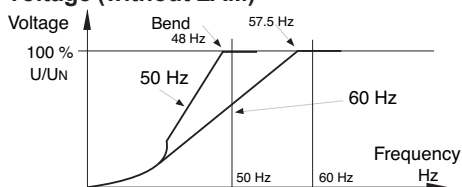

1.3.9 - LAM (Load Acceptance Module) characteristics

The LAM system is integrated in the regulator, as standard it is active (ST5 with bridge). It can be deactivated by removing the ST5 bridge. It can be adjusted to 13% or 25% by means of the ST10 jumper (factory setting 15%).

- Role of the "LAM" (Load Acceptance Module):

On application of a load, the rotation speed of the generator set decreases. When it passes below the preset frequency threshold, the LAM causes the voltage to drop by approximately 13% or 25% and

R449 revision f

AVRs

consequently the amount of active load applied is reduced by approximately 25% to 45%, until the speed reaches its rated value again.

Hence the LAM can be used either to reduce the speed variation (frequency) and its duration for a given applied load, or to increase the applied load possible for one speed variation (turbo-charged engine).

To avoid voltage oscillations, the trip threshold for the LAM function should be set approximately 2 Hz below the lowest frequency in steady state. It is advisable to use the LAM at 25% for load impacts $\geq 70\%$ of the genset rated power.

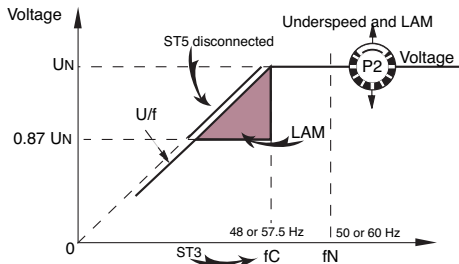

1.3.10 - Typical effects of the LAM with a diesel engine with or without a LAM (U/f only)

1.3.10.1 - Voltage

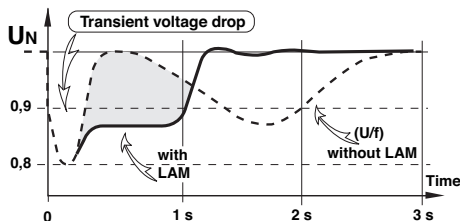

1.3.10.2 - Frequency

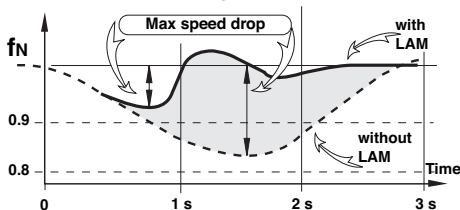

1.3.10.3 - Power

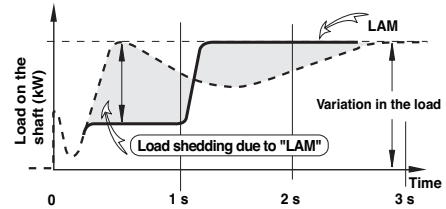

1.3.11 - Gradual voltage return function

During load impacts, the function helps the genset to return to its rated speed faster thanks to a gradual increase in voltage according to the principle:

- if the speed drops between 46 and 50 Hz, the rated voltage follows a fast gradient as it is restored.

- if the speed drops below 46 Hz, since the engine needs more help, the voltage follows a slow gradient as it returns to the reference value.

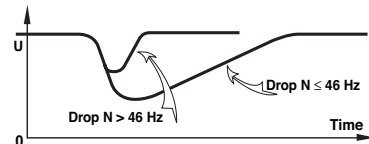

1.3.12 - Stability

The stability and the response time of the alternator can be adjusted using potentiometer P3.

Presetting P3 for different types of alternator:

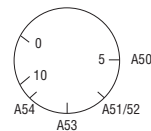

The ST2 jumper modifies the stability. It is closed as standard. Removing this jumper can in some cases improve the response time of the alternator (contact the factory).

1.3.13 - Limiting the excitation current i_{ex}

- The potentiometer P5 is used to adjust the limitation of excitation Amp. Limitation of the excitation current is active for 10s. After this period of time, the excitation current is limited to 2A.

R449 revision f AVRs

The maximum limitation is 15A.

The minimum limitation is when the potentiometer has been rotated fully anti-clockwise.

In the absence of specification to the contrary, P5 is positioned at the clockwise limit.

- Static adjustment of the maximum excitation current.

For this value, the static adjustment is possible when the alternator is stopped, which will not endanger the alternator or the installation.

Disconnect the power supply wires X1,X2 and Z1,Z2 and the alternator voltage reference (terminal strip J1).

Connect the power supply, 200 to 240V, as shown (X1 and X2: 0-220V). Install a 20 ADC ammeter in series with the exciter field.

Turn P5 fully anti-clockwise, switch on the power supply (circuit breaker A).

If the regulator does not discharge, turn potentiometer P2 (voltage) clockwise until the ammeter indicates a stabilised current. Switch the power supply off and then on again, turn P5 clockwise until the required excitation current is reached (limited to 15A), (for precise adjustment contact the factory). Checking the internal protection:

Open the circuit breaker (D): the excitation current must rise to its preset upper limit, maintain this value for 10s and fall back automatically to a value less than 1A.

To reset, switch off the power supply using the circuit breaker (A). Note: After setting the upper excitation limit using this procedure, re-adjust the voltage.

inside the alternator terminal box. Rating: gG 10/38 16A 500V - ATQ20 (10x38US) 500 VAC UL/CSA

1.3.15 - Voltage build-up

The voltage build-up is automatic (no overvoltage) from the residual magnetism. If there is no voltage build-up, a short pulse of continuous isolated voltage (12VDC), will usually remedy this. Otherwise, proceed in accordance with the diagram below to re-establish the residual magnetism:

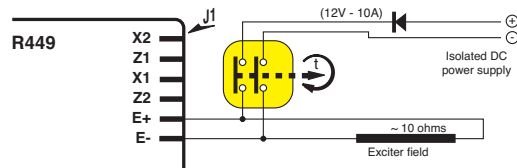

1.3.16 - Power used

The power used by the R449 is 30W, when the alternator is at rated power.

1.3.17 - De-energising

The regulator is de-energised by switching off the voltage regulation power supply. Contact rating: 15A, 250V AC

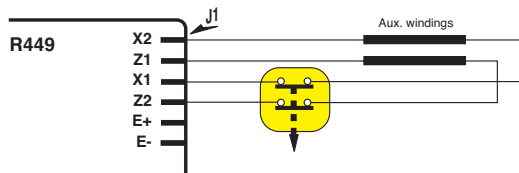

1.4 - Environment

- Operating temperature: - 30°C to +70°C
- Storage temperature: - 55°C to + 85°C
- Shocks on the base: 9g for the 3 right-angled directions
- Vibrations: Less than 10Hz: 2mm half peak amplitude
10Hz to 100Hz: 100mm/s
Above 100Hz: 8g

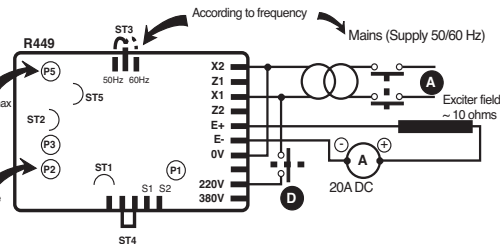

1.3.14 - Protection

There are two fuses in the power section. They are mounted externally to the AVR but

R449 revision f AVRs

2 - R726: REGULATION OF POWER FACTOR (2F) AND MAINS SENSING (3F)

The power factor and mains sensing are done by the R726 module. See the specific manual.

2.1 - Operating diagram

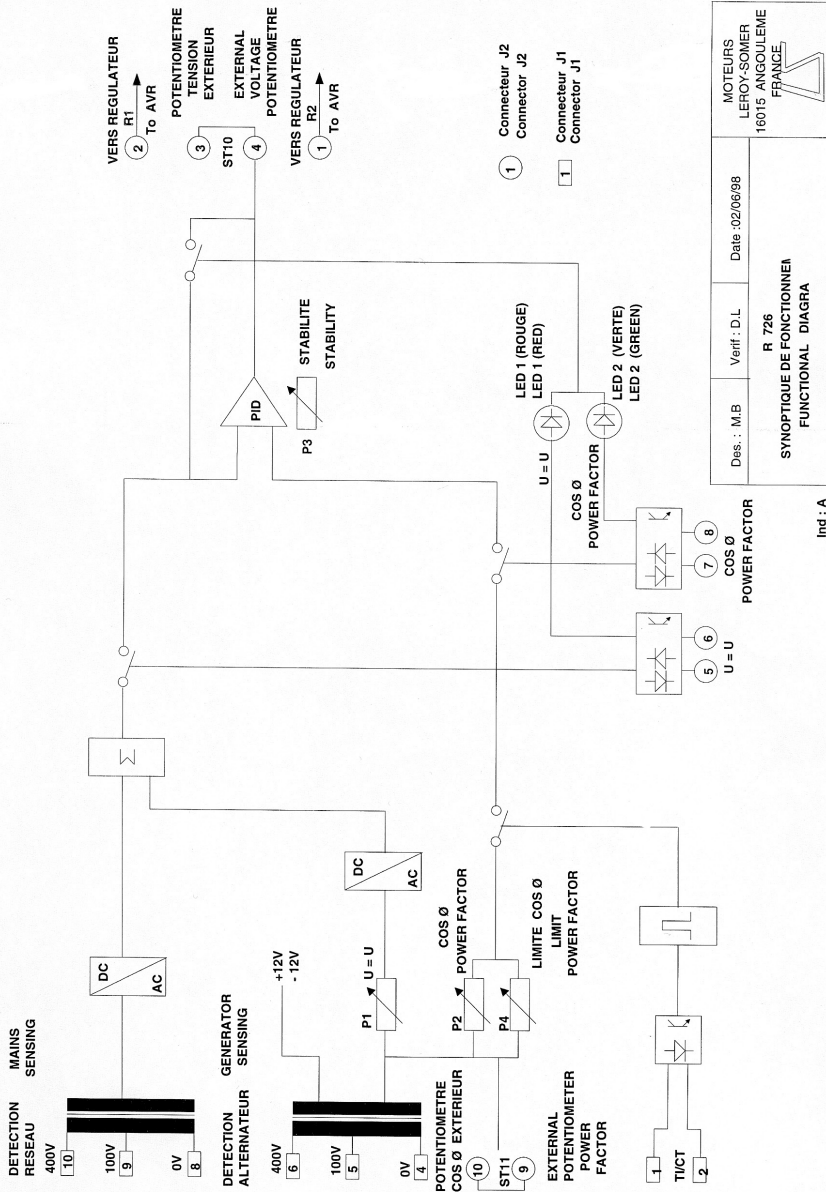

Des. : M.B	Verif. : D.L	Date :02/06/98	
R 726 SYNOPTIQUE DE FONCTIONNEMENT FUNCTIONAL DIAGRAM			

Ind : A

R449 revision f

AVRs

2.2 - Potentiometers

P1: Potentiometer for adjusting the alternator voltage to the mains voltage (operating mode 3F)

P2: Adjustment of the power factor

P3: Stability

P4: Limitation of the power factor

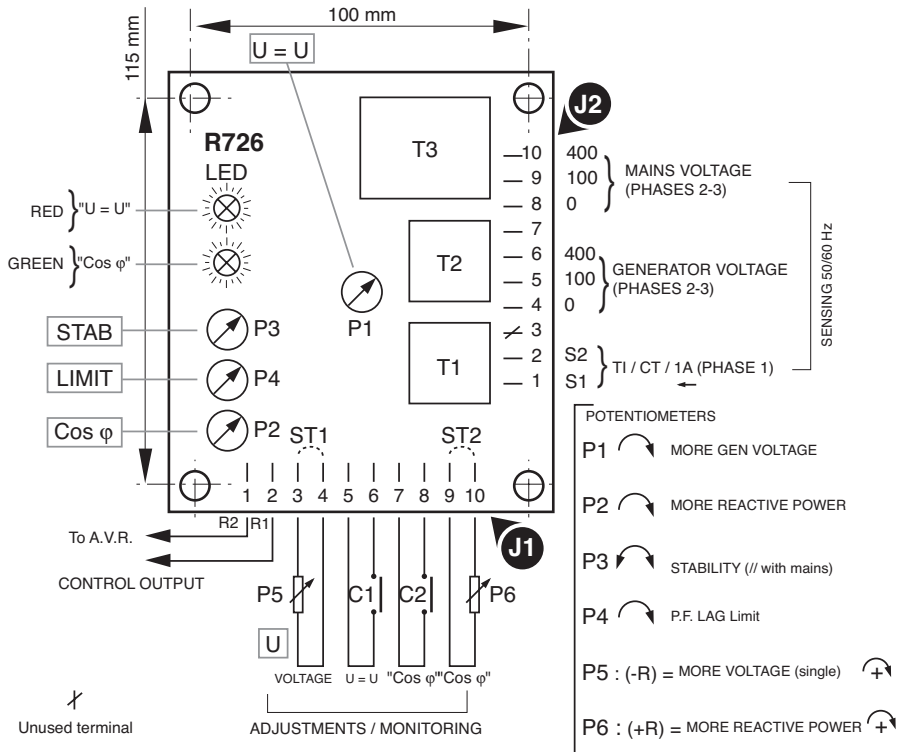

R449 revision f AVRs

3 - TYPICAL DIAGRAMS

The following diagrams are supplied for information only and are not to be used in place of the actual alternator diagrams.

3.1 - AREP 1F LV excitation

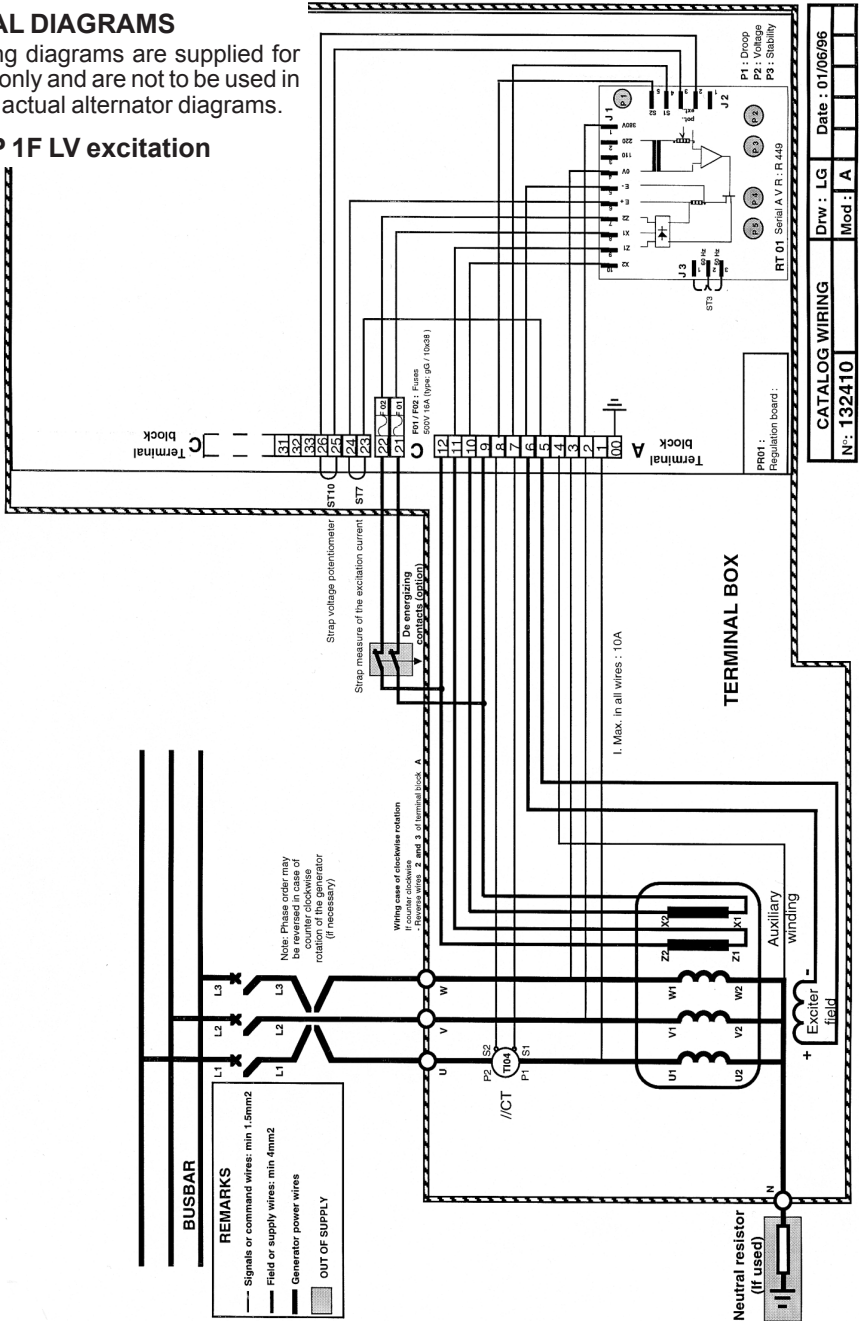

R449 revision f AVRs

3.2 - AREP 1F MV excitation

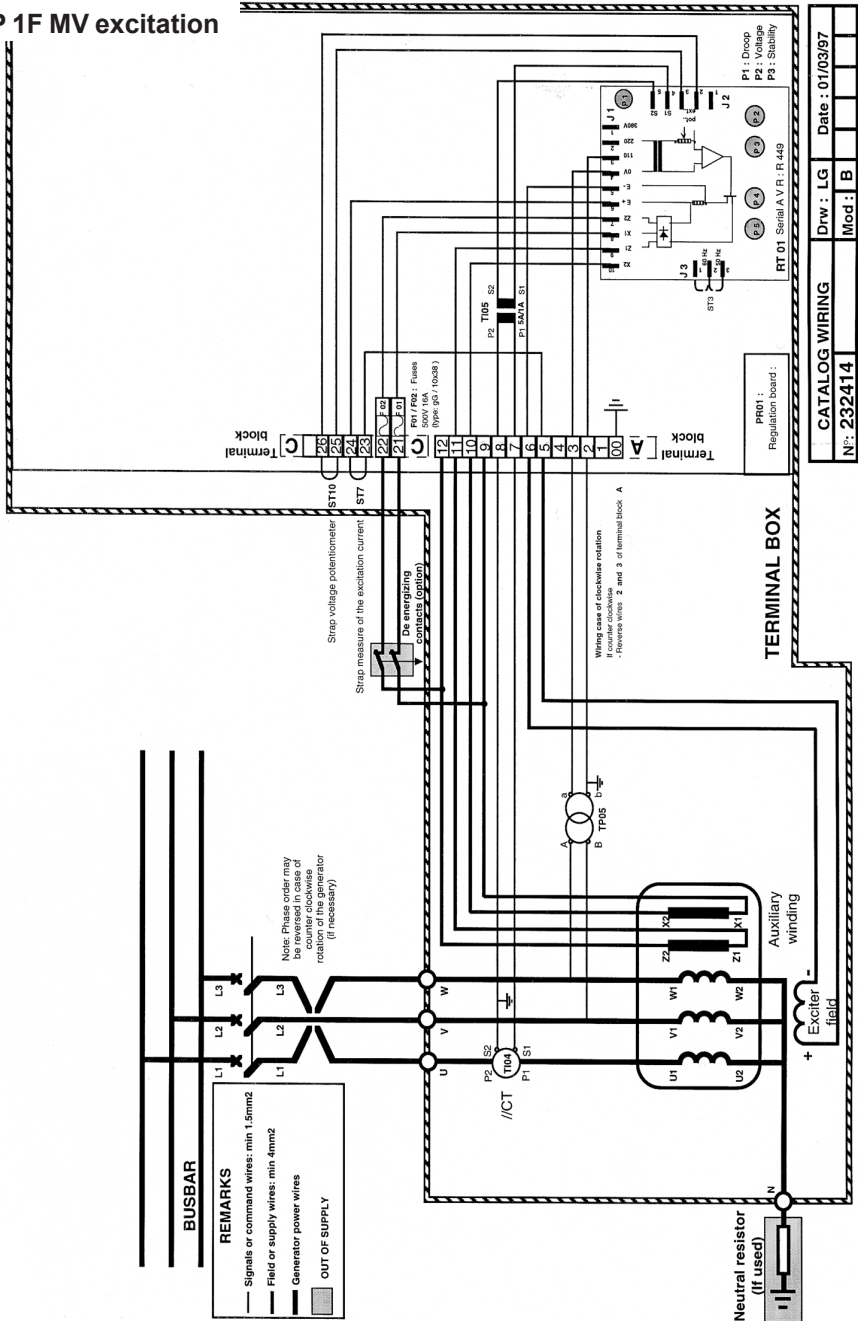

CATALOG WIRING	Draw : LG	Date : 01/03/97
N°: 232414	Mod : B	

R449 revision f AVRs

3.3 - AREP 3F LV excitation

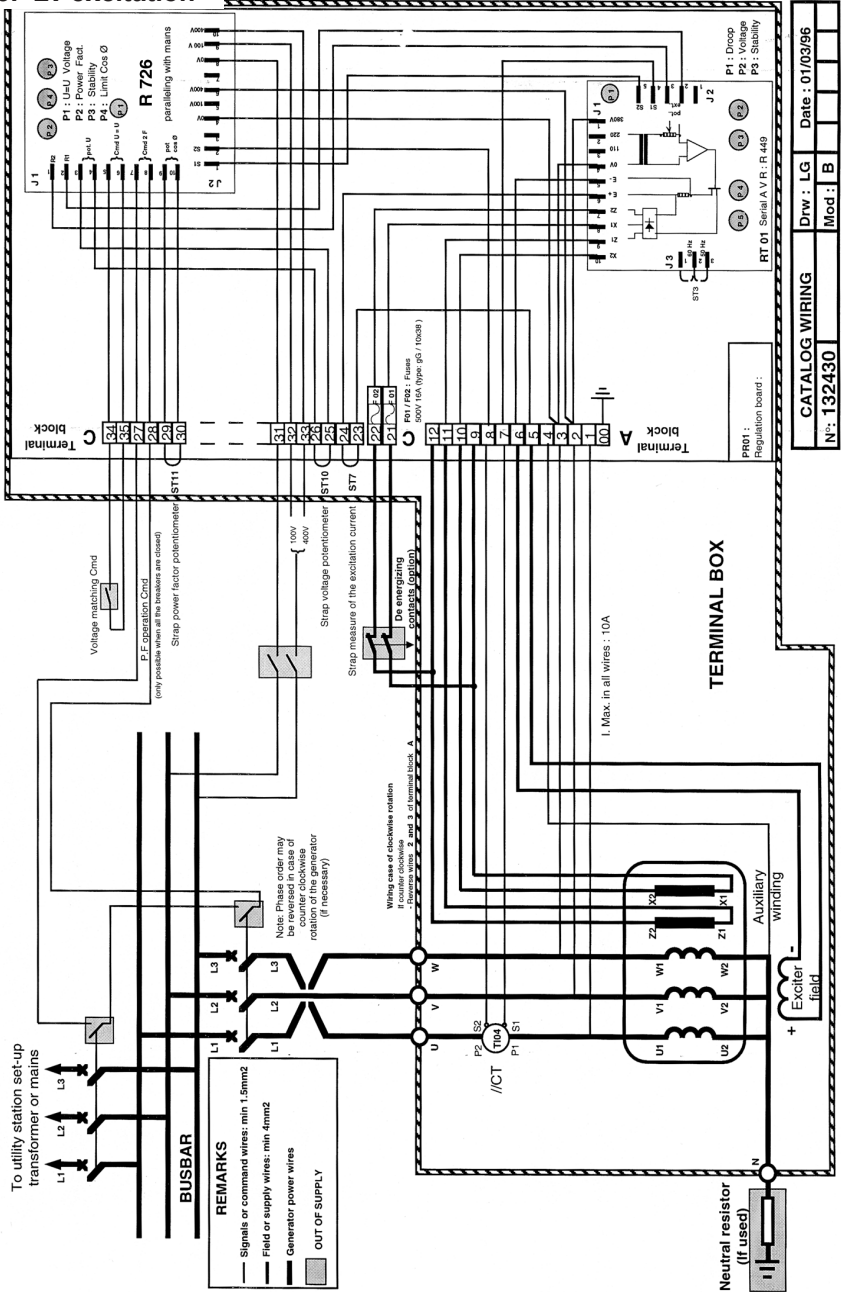

DATE	01/03/96
DRW	LG
MOD	B
CATALOG WIRING	
N°	132430

R449 revision f AVRs

3.4 - AREP 3F MV excitation

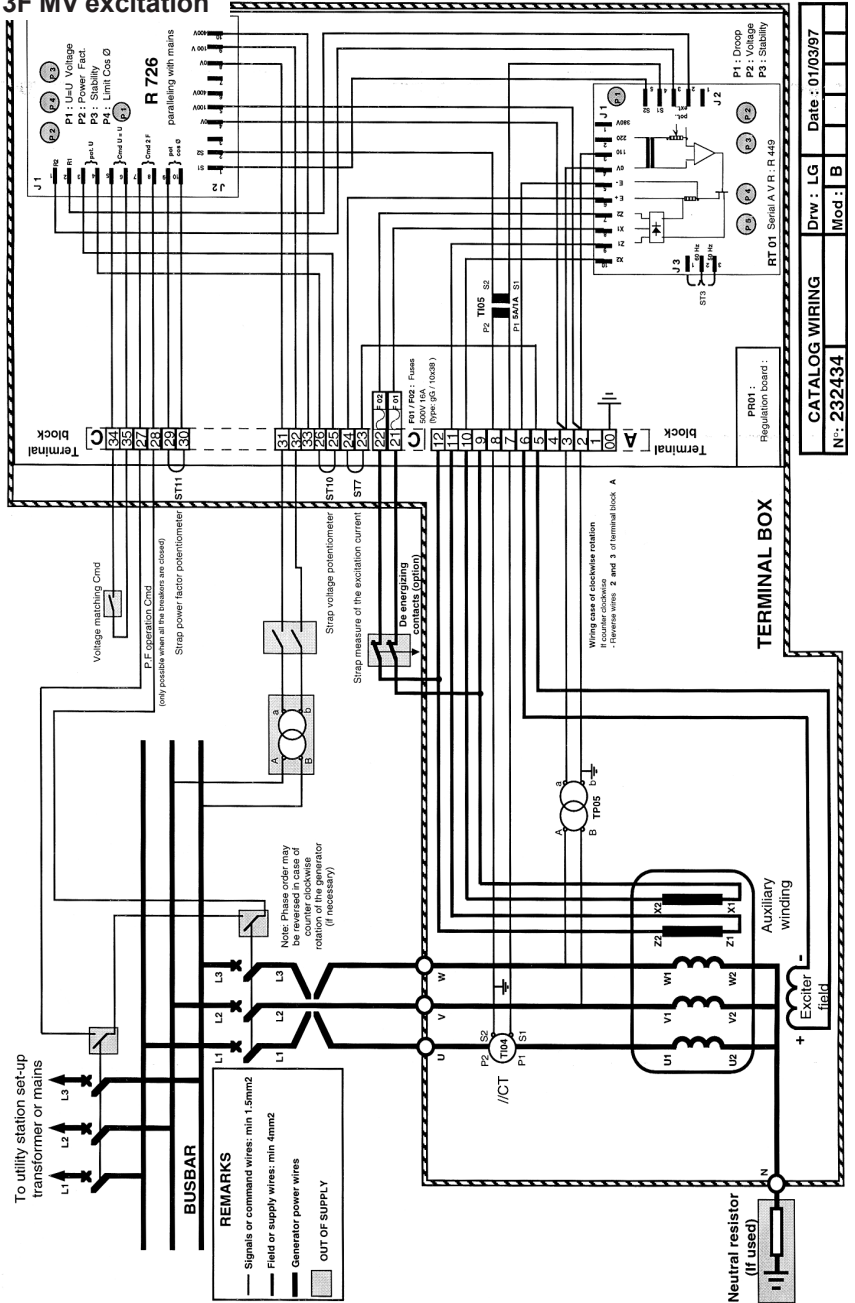

CATALOG WIRING	Draw : LG	Date : 01/03/97
	Mod : B	
N°: 232434		

R449 revision f AVRs

3.6 - 1F LV PMG excitation

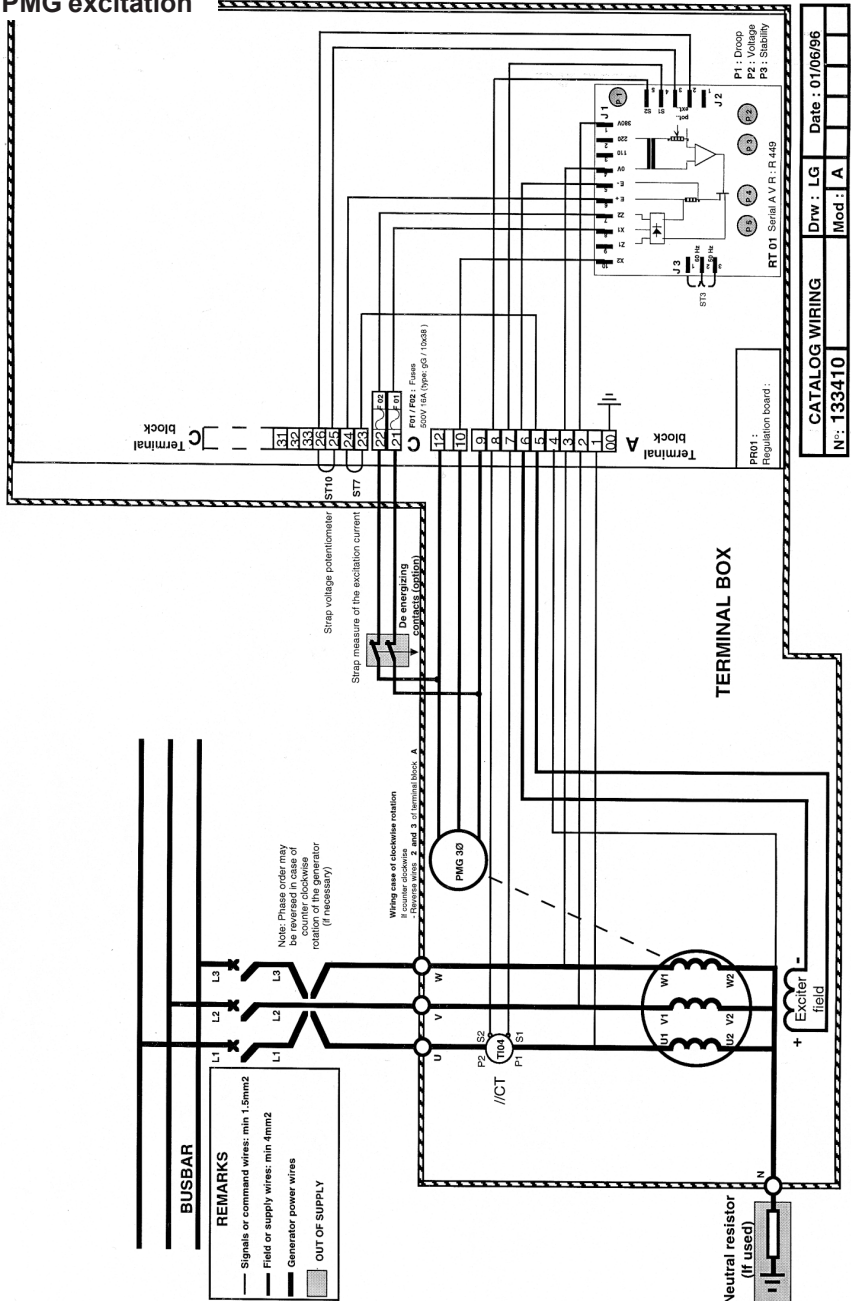

R449 revision f AVRs

4 - COMMISSIONING

The commissioning principle is the same whatever is the type of excitation.

4.1 - In case of standalone regulation

- Check fuses F1 and F2 which are situated on terminal block C in the alternator.
- Check the regulator:
 - Check the position of the ST3 jumper (select the frequency, 50 or 60Hz).
 - If an external voltage potentiometer is used, disconnect it from the regulator and install the ST4 jumper (regulator terminal block J2) or the ST10 jumper, terminal block C in the alternator terminal box.
 - Turn the internal voltage potentiometer P2 on the regulator fully anti-clockwise.
 - Set the alternator to its rated speed using the drive system.
 - The alternator voltage should rise to a value of 85 to 90%U_n.
 - Adjust the voltage to the required value using potentiometer P2.
 - Turn potentiometer P1 fully anti-clockwise.
 - Perform an on-load test with power factor = 0.8 or power factor = 1. The voltage should remain constant within the limits of the regulator. If it is not stable, see section 1.3.9.
 - Stop the alternator and reconnect the external potentiometer, setting it to the centre position.
 - Set the alternator to its rated speed then, using the external potentiometer, set the alternator to its rated voltage.
 - The regulator set-up phase is now complete.

4.2 - In case of 1f regulation (parallel operation between alternators)

- The previous settings should be made on each alternator.
- Set the quadrature droop potentiometer to the centre position and perform an on-load test.
 - With a load at power factor = 1, the voltage does not drop or only drops slightly; with an inductive load, the voltage drops. This voltage drop is set using quadrature droop potentiometer P1. The no-load voltage is

always greater than the on-load voltage, if the voltage rises, invert the parallel operation CT. The voltage quadrature droop is generally 2 to 3% of the rated voltage.

- The no-load voltages should be identical on all the alternators intended for parallel operation between each other.
- Connect the alternators in parallel at no load.
 - Adjust the setting of voltage P2 or the external voltage potentiometer of one of the machines, try to eliminate (or minimise) the circulating stator current between the machines.
 - Do not adjust the voltage further.
 - Match the kW power with a minimum load of 30% by adjusting the drive system speed.
 - Adjust quadrature droop potentiometer P1 on one of the machines to balance or distribute the stator currents.
 - If several alternators are in parallel, take one as a reference.

4.3 - In case of 2f (power factor regulation) and 3f (voltage match circuit) (see R726 manual ref. 2440)

- Check the wiring between the R449 and the R726. (See the connection diagram).
- Check the information given for the R726: mains voltage, 2F contact, 3F contact.
 - If an external voltage potentiometer is used, disconnect it from the R726 and add the ST1 jumper (terminals 3 and 4 of J1) or disconnect it from terminals 25 and 26 of terminal block C of the alternator and add the ST10 jumper.
 - If an external PF potentiometer is used, disconnect it from the R726 and add the ST2 jumper (terminals 9 and 10 of J1) or disconnect it from terminals 29 and 30 of terminal block C of the alternator and add the ST11 jumper.
 - Perform a 1F test.
- The test principle is the same as in the case of 1F regulation.
 - Matching the alternator and mains voltages prior to synchronisation (3F):
 - If this function is not used, match the voltages by adjusting the voltage potentiometer.

R449 revision f AVRs

The following settings are for the R726.

Close the 3F contact (terminals 5 and 6 of J1 of the R726 or terminals 34 and 35 of terminal block C of the alternator). The red LED lights up. Adjust potentiometer P1 to match the alternator voltage to the mains voltage.

- Power factor regulation with the alternator synchronised with the mains (2F):

The following settings are for the R726.

When the alternator is in phase with the mains and the mains and alternator voltages are equal, proceed with synchronisation. Contact 2F closes when the circuit breaker is closed. The green LED on the R726 lights up. Open contact 3F and remove the mains voltage reference.

Preset the PF potentiometer P2 to 5 and limit potentiometer P4 to 3.5.

Without supplying kW power to the mains, the reactive current of the alternator should be at or around 0.

Increase the kW power. When it reaches 50% of the rated power, adjust potentiometer P4 to obtain a PF of 0.9 LAG (inductive) on the alternator. The range is then 0.7 LAG PF (inductive) (P2 turned fully clockwise) to 0.95 LEADING (capacitive) (P2 turned fully anti-clockwise).

Adjust P2 to obtain the required power factor value.

Increase the kW power until it reaches the rated power. The PF should remain constant. If it becomes unstable, adjust potentiometer P3 on the R726 or potentiometer P3 on the R449.

- Stop the alternator and reconnect the external potentiometers.

R449 revision f

AVRs

5 - TROUBLESHOOTING

5.1 - Checking the windings and rotating diodes using a separate excitation

During this procedure, you must check that the alternator is not connected to any external loads and examine the terminal box to check that the connections have been made correctly.

- Stop the generator, disconnect and isolate the regulator wires.
- There are two possible assemblies for a separate excitation: see the diagrams below.
- Assembly A: Connect the DC supply (2 batteries in series) in series with a rheostat of approximately 20 ohms/500W and a diode on both field winding wires (5+) (6-).

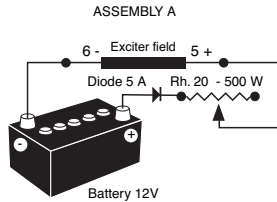

- Assembly B: Connect a «variac» variable power supply and a diode bridge to both field winding wires (5+) (6-).
- These two systems must be compatible with the excitation rating of the machine (see the nameplate).
- Run the generator set at its nominal speed.
- Gradually increase the power supply current of the field winding by adjusting the rheostat or variac and measure output voltages L1, L2, L3, checking the no-load excitation voltages and currents. (See the alternator nameplate or ask factory for the test log).
- If the output voltages are at their rated values and are balanced at < 1% for the given excitation value, the machine is operating correctly and the fault is due to the regulation part (regulator, wiring, sensing, auxiliary windings).



When the alternator is stopped, mains voltage may still be present at the module voltage sensing terminals.



Do not perform dielectric tests without disconnecting the module and associated AVR.

RISK OF DESTRUCTION

ASSEMBLY B

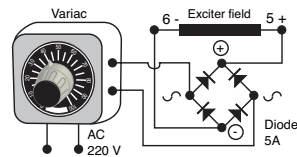

5.2 - Static checking of the regulator

If the regulator operates correctly during a static test, this does not necessarily mean that it will operate correctly under real conditions.

If the regulator fails the static test, it can be concluded without doubt that the regulator is faulty.

Connect a test bulb in accordance with the diagram.

The power supply voltage must be between 200 and 240V. The voltage of the bulb is 230V. The power of the bulb will be less than 100W.

- Turn potentiometer P2 fully anti-clockwise.
- Switch the regulator on; the bulb must briefly light up and then go out.
- Slowly turn the voltage potentiometer clockwise, to the right.
- When turned fully clockwise, the bulb lights up continuously.
- At the regulation point, turning the voltage adjustment potentiometer slightly in one direction or the other should make the bulb light up or go out. If the bulb is either lit continuously or does not light up at all, the regulator is faulty.

R449 revision f AVRs

- Perform one test supplying the regulator via terminals X1 and X2, then another supplying it via terminals Z1 and Z2.

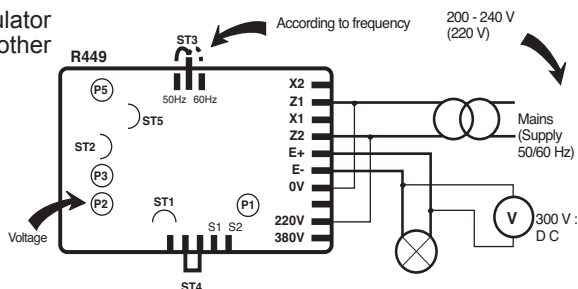

5.3 - Troubleshooting table

Before taking any action on the R449 or the R726, pay careful attention to the positions of the potentiometers and the jumpers.

5.3.1 - In case of 1F, parallel operation between alternators

Symptom	Probable causes	Solutions
Absence of voltage on start-up, at no load	<ul style="list-style-type: none"> - No residual magnetism or polarity inversion between the excitation output and the exciter input - De-energising contacts open - The speed is less than the rated speed - Connection lost between the regulator and the exciter - Alternator loaded or short-circuited - External potentiometer connected incorrectly - Faulty regulator - Faulty exciter or rotating diode bridge - Fuses blown 	<ul style="list-style-type: none"> - Voltage built-up is required - Close this contact - Adjust the speed. - Check the wiring - Remove the load from the alternator - Check the wiring - Test it or change it - Check the exciter and the diodes - Replace the fuses
Voltage too high and adjustment potentiometer not operating	<ul style="list-style-type: none"> - Incorrect voltage at the sensing terminals - Loss of sensing - The external potentiometer has an incorrect value - Faulty regulator 	<ul style="list-style-type: none"> - Check the wiring of the 0, 110V, 220V, 380V terminals on terminal block J1 - Check the wiring - Set a potentiometer with the correct value - Test it or change it
Voltage too high, but adjustable by the adjustment potentiometer	<ul style="list-style-type: none"> - Voltage potentiometer set too high - Regulator sensing incorrect - Regulator faulty 	<ul style="list-style-type: none"> - Adjust voltage potentiometer P2 or the external potentiometer - Check the wiring and the sensing value, at 0V and 110V, 220V, 380V terminals - Test it or change it
Voltage too low, but adjustable by the adjustment potentiometer	<ul style="list-style-type: none"> - ST3 and ST4 jumpers - The speed is too low - Exciter and rotating diodes 	<ul style="list-style-type: none"> - Check the presence of the ST3 and ST4 jumpers - Set to the correct speed - Check the exciter and the rotating diodes
Incorrect regulation	<ul style="list-style-type: none"> - Distortion of the waveform, non-linear load - Unbalanced load - The speed is not at the correct value - Exciter or rotating diodes faulty - Faulty regulator 	<ul style="list-style-type: none"> - Contact the factory - Balance the load or change the sensing points - Adjust the speed - Check the exciter and the rotating diodes - Test it or change it

R449 revision f AVRs

Symptom	Probable causes	Solutions
Voltage unstable	<ul style="list-style-type: none"> - Frequency unstable - Secondary sensing of a transformer supplying other devices - Stability potentiometer P3 is incorrectly set - Faulty regulator 	<ul style="list-style-type: none"> - Check the stability of the drive system speed - Provide separate sensing for the alternator - Adjust stability potentiometer P3 - Test it or change it
Response time too long	<ul style="list-style-type: none"> - Stability adjustment - Speed regulator response too long 	<ul style="list-style-type: none"> - Adjust stability potentiometer P3 and the ST2 jumper - Adjust the stability of the speed
Considerable drop in voltage, on-load	<ul style="list-style-type: none"> - Vectorial composition fault between the voltage and the current - The parallel operation CT ratio is incorrect 	<ul style="list-style-type: none"> - Check the wiring of the sensing and parallel operation CT - Correct the CT ratio
kVAR not stable between alternators (reactive current circulation)	<ul style="list-style-type: none"> - Quadrature droop potentiometer needs adjusting - The no-load voltages are not identical - Phases not connected to the sensing correctly - The CT is not on the correct phase 	<ul style="list-style-type: none"> - Adjust the quadrature droop potentiometer - Check that all the alternators have the same no-load voltage value - Check the sensing wiring - Check the position of the parallel operation CT



Warning : after operational testing, replace all access panels or covers.

5.3.2 - Example of 2F and 3F

Symptom	Probable causes	Solutions
Incorrect regulation of PF, PF potentiometer not operating	<ul style="list-style-type: none"> - Vectorial composition fault between the sensing voltage and the stator current - R726 faulty - R726 ST2 jumper missing - Wiring fault between the R449 and the R726 	<ul style="list-style-type: none"> - Check the sensing wiring and the parallel operation CT - Change the module - Check the wiring, in particular the wires between 1 and 2 of terminal block J1 on the R726
PF range incorrect.	<ul style="list-style-type: none"> - Settings on potentiometers P2 incorrect 	<ul style="list-style-type: none"> - Reset the range as shown above
The LEDs will not light up	<ul style="list-style-type: none"> - Contacts 2F and 3F missing 	<ul style="list-style-type: none"> - Check the wiring
Cannot adjust the voltage matching circuit	<ul style="list-style-type: none"> - The sensing voltage is incorrect or incorrectly connected 	<ul style="list-style-type: none"> - Check the wiring and the value of the voltage



Warning : after operational testing, replace all access panels or covers.

R449 revision f AVRs

5.3.3 - Checking the alternator using a separate excitation

- The alternator is tested at no load.
- Disconnect the R449 and R726 and the entire excitation system of the alternator.
- Connect a 24V 5A variable DC supply to the exciter field wires.

Apply a direct current to the exciter to obtain the rated voltage.

- Check all the alternator parameters: stator voltage, field winding voltage, AREP or regulator power transformer voltages, sensing voltage at the regulator terminal block.

- All these parameters should be checked against the alternator characteristics.

5.4 - Replacing the regulator with a spare voltage regulator

Set the potentiometers and the jumpers in the same way as the original regulator.

6 - SPARE PARTS

6.1 - Designation

Description	Type	Code
AVR	R449	AEM 220 RE 030

6.2 - Technical support service

Our technical support service will be pleased to provide any additional information you may require.

For all spare parts orders or technical support requests, send your request to service.epg@leroy-somer.com or your closest contact, whom you will find at www.lrsom.co/support indicating the type and the code number of the AVR.

To ensure that our products operate correctly and safely, we recommend the use of original manufacturer spare parts.

In the event of failure to comply with this advice, the manufacturer cannot be held responsible for any damage.

R449 revision f AVRs

Disposal and recycling instructions

We are committed limiting the environmental impact of our activity. We continuously monitor our production processes, material sourcing and products design to improve recyclability and minimise our environmental footprint.

These instructions are for information purposes only. It is the user's responsibility to comply with local legislation regarding product disposal and recycling.

Waste & hazardous materials

The following components and materials require special treatment and must be separated from the alternator before the recycling process:

- electronic materials found in the terminal box, including the automatic voltage regulator (198), current transformers (176), interference suppression module (199) and other semi-conductors.
- diode bridge (343) and surge suppressor (347), found on the alternator rotor.
- major plastic components, such as the terminal box structure on some products. These components are usually marked with information concerning the type of plastic.

Service & Support

Our worldwide service network of over 80 facilities is at your service.

This local presence is our guarantee for fast and efficient repair, support and maintenance services.

Trust your alternator maintenance and support to electric power generation experts. Our field personnel are 100% qualified and fully trained to operate in all environments and on all machine types.

We have a deep understanding of alternator operation, providing the best value service to optimise your cost of ownership.

Where we can help:

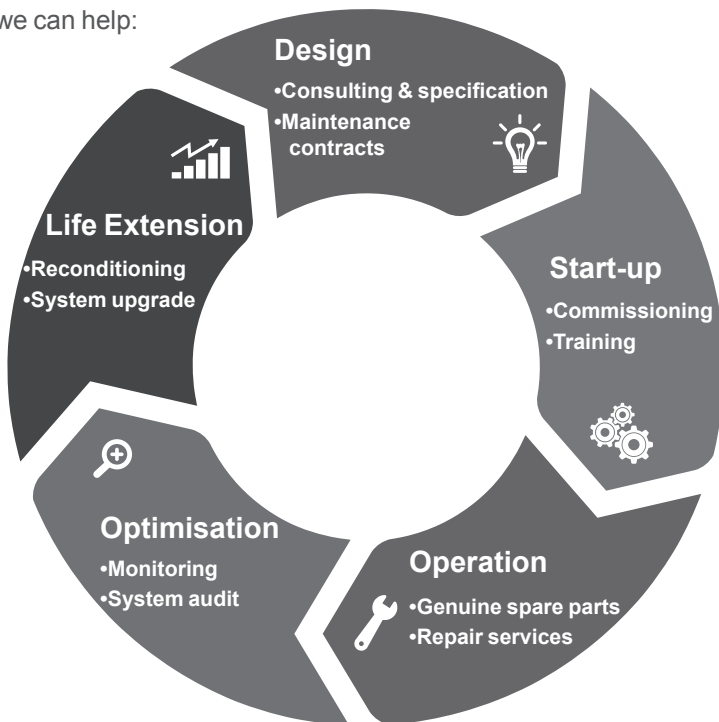

Contact us:

Americas: +1 (507) 625 4011

Europe & Rest of the world: +33 238 609 908

Asia Pacific: +65 6250 8488

China: +86 591 88373036

India: +91 806 726 4867

Middle East: +971 4 811 8483



Scan the code or go to:

 service.epg@leroy-somer.com

www.lrsm.co/support

LEROY-SOMER[™]

www.leroy-somer.com/epg

[Linkedin.com/company/Leroy-Somer](https://www.linkedin.com/company/Leroy-Somer)
[Twitter.com/Leroy_Somer_en](https://twitter.com/Leroy_Somer_en)
[Facebook.com/LeroySomer.Nidec.en](https://www.facebook.com/LeroySomer.Nidec.en)
[YouTube.com/LeroySomerOfficiel](https://www.youtube.com/LeroySomerOfficiel)



Nidec
All for dreams