

**TAL 040**

## **Low Voltage Alternator - 4 pole**

Installation and maintenance

**LEROY-SOMER™**

***Nidec***  
All for dreams

# TAL 040

## Low Voltage Alternator - 4 pole

**This manual concerns the alternator which you have just purchased.  
We wish to draw your attention to the contents of this maintenance manual.**

### SAFETY MEASURES

Before using your machine for the first time, it is important to read the whole of this installation and maintenance manual.

All necessary operations and interventions on this machine must be performed by a qualified technician.

Our technical support service will be pleased to provide any additional information you may require.

The various operations described in this manual are accompanied by recommendations or symbols to alert the user to potential risks of accidents. It is vital that you understand and take notice of the following warning symbols.

#### WARNING

**Warning symbol for an operation capable of damaging or destroying the machine or surrounding equipment.**



**Warning symbol for general danger to personnel.**



**Warning symbol for electrical danger to personnel.**

### SAFETY INSTRUCTIONS

We wish to draw your attention to the following 2 safety measures which must be complied with:

**a) During operation, do not allow anyone to stand in front of the air outlet guards, in case anything is ejected from them.**

**b) Do not allow children younger than 14 to go near the air outlet guards.**

A set of self-adhesive stickers depicting the various warning symbols is included with this maintenance manual. They should be positioned as shown in the drawing below once the machine has been fully installed.

### WARNING

**The alternators must not be put into service until the machines in which they are to be incorporated have been declared compliant with EC Directives plus any other directives that may be applicable.**

**This manual is to be given to the end user.**

**The range of electric alternators and their derivatives, manufactured by us or on our behalf, comply with the technical requirements of the customs Union directives.**

**The alternator is a sub-assembly delivered without a system of protection against short-circuits. The protection must be provided by the circuit-breaker of the generator, sized to interrupt the fault current.**

© 2022 Moteurs Leroy-Somer SAS  
Share Capital: 38,679,664 €, RCS Angoulême  
338 567 258.

We reserve the right to modify the characteristics of this product at any time in order to incorporate the latest technological developments. The information contained in this document may therefore be changed without notice.

This document may not be reproduced in any form without prior authorization.

All brands and models have been registered and patents applied for.

# TAL 040

## Low Voltage Alternator - 4 pole

### CONTENTS

<b>1 - RECEIPT .....</b>	<b>4</b>
1.1 - Standards and safety measures .....	4
1.2 - Inspection .....	4
1.3 - Identification .....	4
1.4 - Storage .....	4
1.5 - Applications .....	4
1.6 - Usage restrictions .....	4
<b>2 - TECHNICAL CHARACTERISTICS .....</b>	<b>5</b>
2.1 - Electrical characteristics .....	5
2.2 - Mechanical characteristics .....	5
<b>3 - INSTALLATION .....</b>	<b>10</b>
3.1 - Assembly .....	10
3.2 - Checks prior to first use .....	11
3.3 - Terminal connection diagrams .....	11
3.4 - Commissioning .....	14
3.5 - Setting up .....	14
<b>4 - SERVICING - MAINTENANCE .....</b>	<b>15</b>
4.1 - Safety measures .....	15
4.2 - Routine maintenance .....	15
4.3 - Bearings .....	16
4.4 - Mechanical defects .....	16
4.5 - Electrical faults .....	17
4.6 - Dismantling, reassembly .....	19
4.7 - Table of characteristics .....	21
<b>5 - SPARE PARTS .....</b>	<b>23</b>
5.1 - First maintenance parts .....	23
5.2 - Technical support service .....	23
5.3 - Accessories .....	23
5.4 - Exploded view, parts list and tightening torque .....	24

**Disposal and recycling instructions**

**EC Declaration**

# TAL 040

## Low Voltage Alternator - 4 pole

### 1 - RECEIPT

#### 1.1 - Standards and safety measures

Our alternators comply with most international standards.

See the EC Declaration of Incorporation on the last page.

#### 1.2 - Inspection

On receipt of your alternator, check that it has not suffered any damage in transit. If there are obvious signs of knocks, contact the transporter (you may be able to claim on their insurance) and after a visual check, turn the machine by hand to detect any malfunction.

#### 1.3 - Identification

The alternator is identified by means of a nameplate fixed on the machine (see drawing).

Make sure that the nameplate on the machine conforms to your order.

So that you can identify your alternator quickly and accurately, we suggest you fill in its specifications on the nameplate below.

#### 1.4 - Storage

Prior to commissioning, machines should be stored:

- away from humidity (< 90%); after a long period of storage, check the machine insulation. To prevent the bearings from becoming marked, do not store in an environment with significant vibration.

#### 1.5 - Applications

This alternator is mainly designed to produce electricity in the context of applications involving the use of generators.

#### 1.6 - Usage restrictions

Use of the machine is restricted to operating conditions (environment, speed, voltage, power, etc) compatible with the characteristics indicated on the nameplate.

# Nidec LEROY-SOMER™

Model	TAL		
S/N		Date	
Enclosure		Protection	
Th. Class		Altitude	
Weight		PF	
AVR		Excitation	
Excitation 415 v / 40°C	No Load	Full Load	
DE bearing			
NDE bearing			

Freq.	Hz						
Speed	min <sup>-1</sup>						
Voltage	V						
Phase							
Connection							
Cont. BR 40°C	kVA						
	kW						
	A						
Std by. PR 27°C	kVA						
	kW						
	A						



IEC 60034 - 1 & 5  
ISO 8528 - 3  
NEMA MG1 - 32 & 33



LSA 000-1-148 a

MOTEURS LEROY-SOMER  
2 BD MARCELLIN LEROY - 16000 ANGOULÊME - FRANCE

[www.leroy-somer.com](http://www.leroy-somer.com)

Made in Europe by Leroy-Somer

Scan the code or go to  
GEN.LS1.DO  
to check product data

# TAL 040

## Low Voltage Alternator - 4 pole

### 2 - TECHNICAL CHARACTERISTICS

#### 2.1 - Electrical characteristics

This alternator is a machine without sliprings or revolving armature brushes, wound as "2/3 pitch", 4, 6 or 12-wire, with class H insulation and a field excitation system available in either SHUNT or AREP+ version (see diagrams and AVR manuals).

##### • Electrical options

- Space heaters
- R791 interference suppression

##### • SHUNT dedicated single-phase 4-wire

#### 2.2 - Mechanical characteristics

- Steel frame
- Aluminum end shields
- Protected ball bearings, greased for life
- Mounting arrangements: single bearing with standard feet and SAE flanges/coupling discs
- Drip-proof machine, self-cooled
- Degree of protection: IP 23

##### • Mechanical options

- Direct output power by cables (not reconnectable), regulator fitted outside the alternator

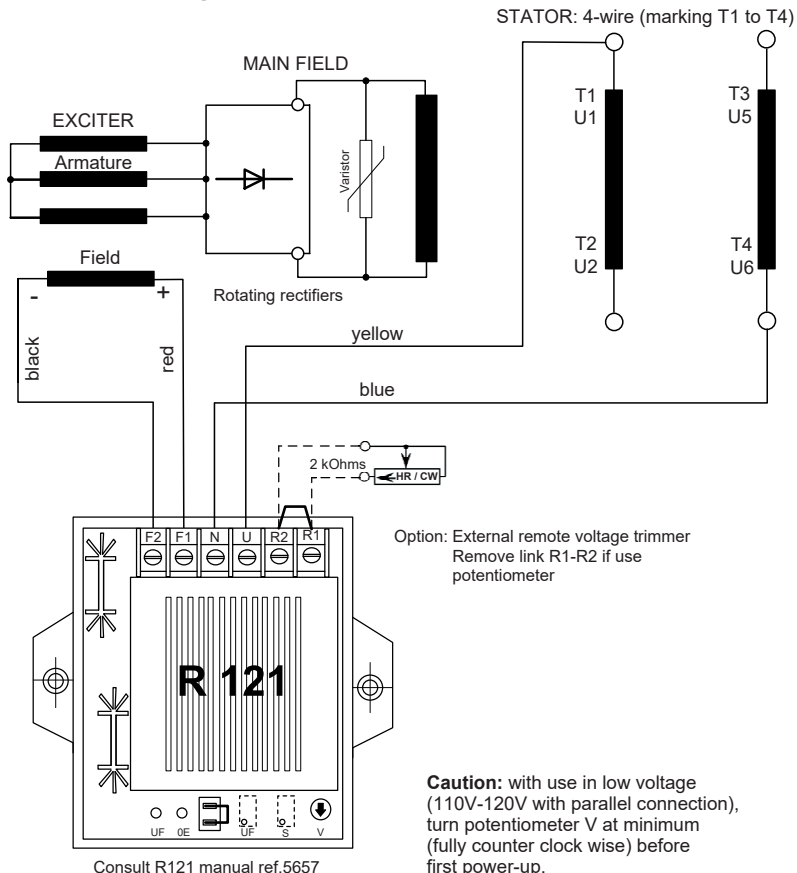

# TAL 040

## Low Voltage Alternator - 4 pole

### • SHUNT three-phase 6-wire

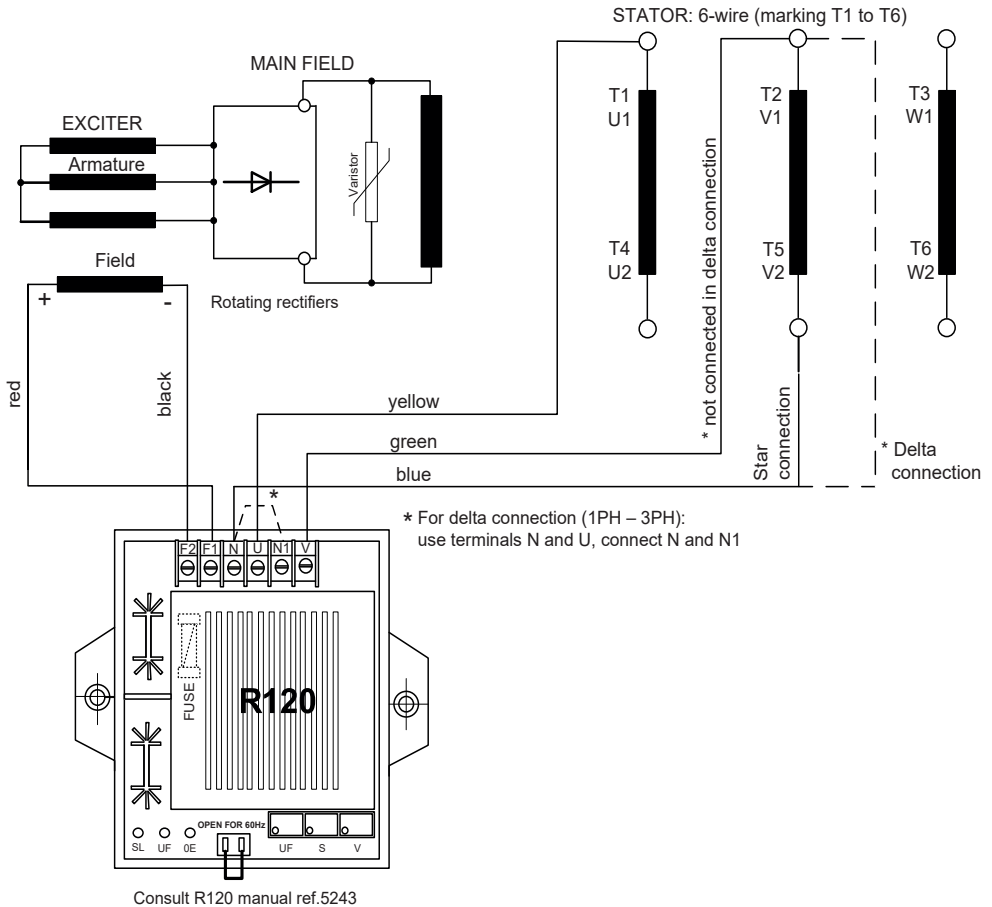

# TAL 040

## Low Voltage Alternator - 4 pole

• **SHUNT three-phase 12-wire**

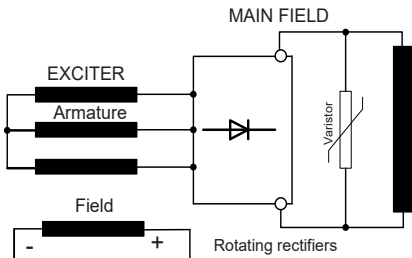

STATOR: 12-wire (marking T1 to T12)

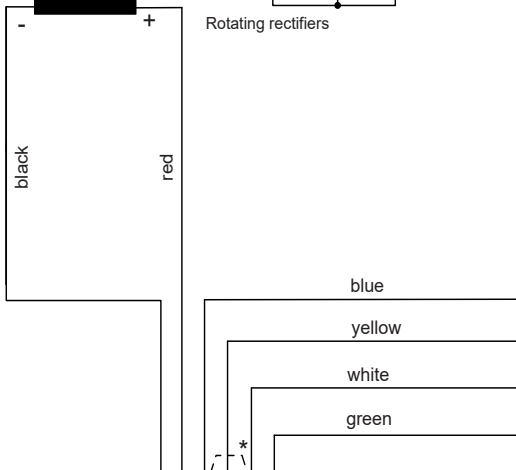
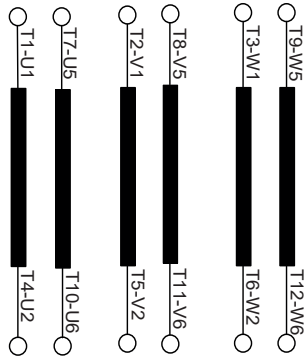

D	3 PH			1 PH	
	A	F	FF	G	
T10	T3	T2	T10	T2	
T1	T1	T1	T1	T3	
N.C.	T2	N.C.	N.C.	N.C.	
T2	N.C.	N.C.	N.C.	N.C.	

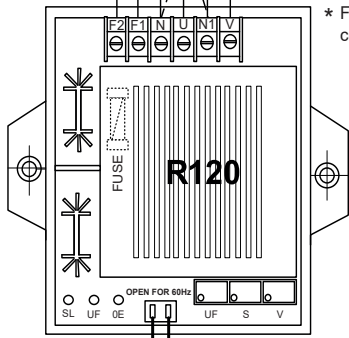

\* For F, FF and G connections:  
connect N and N1

Consult R120 manual ref.5243

# TAL 040

## Low Voltage Alternator - 4 pole

### •AREP+ three-phase 6-wire

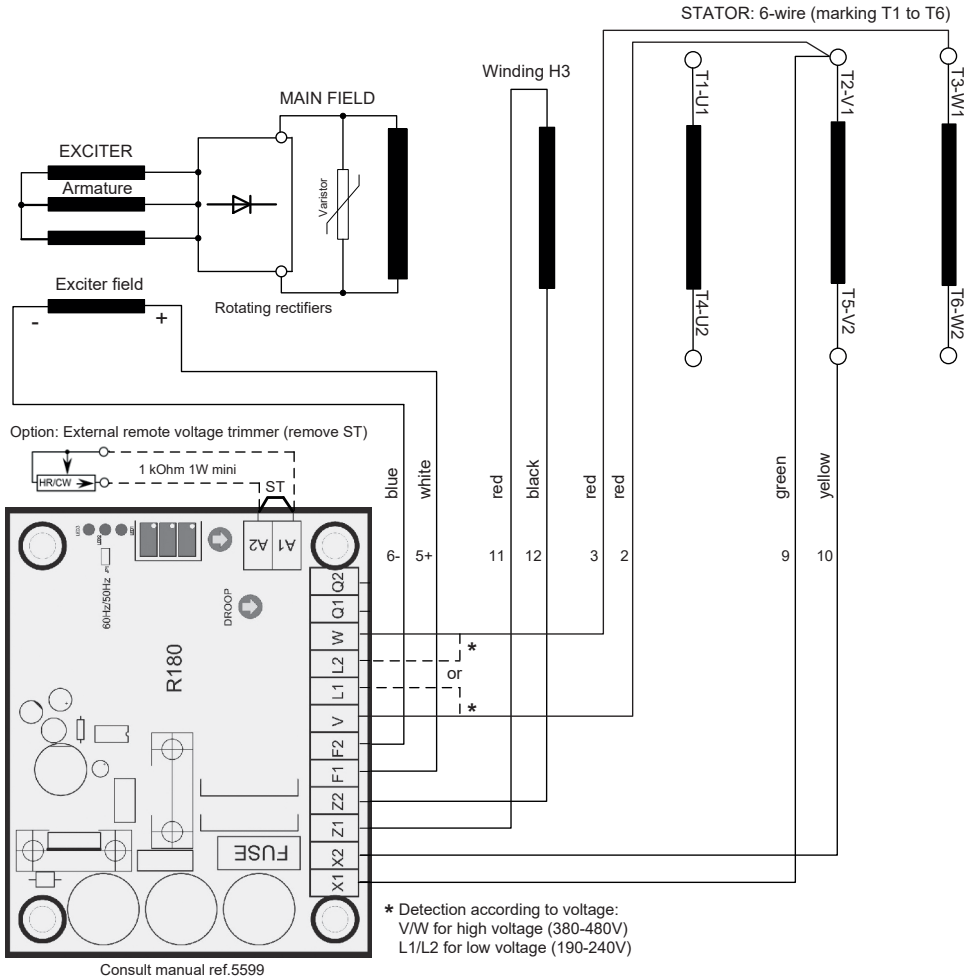

The PMG option is not available with TAL 040.



# TAL 040

## Low Voltage Alternator - 4 pole

• AREP+ three-phase 12-wire

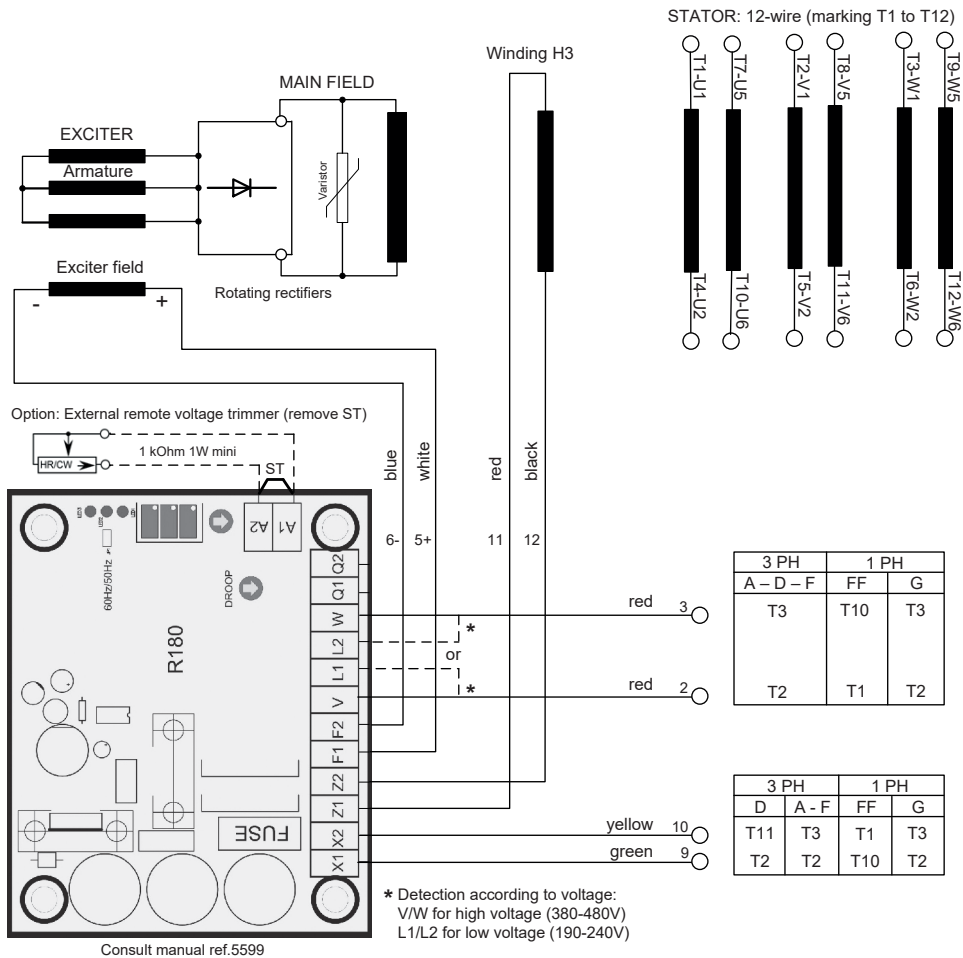

The PMG option is not available with TAL 040.

# TAL 040

## Low Voltage Alternator - 4 pole

### 3 - INSTALLATION

Personnel undertaking the various operations indicated in this section must wear personal protective equipment appropriate for mechanical and electrical hazards.

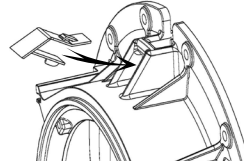

#### 3.1 - Assembly



All mechanical handling operations must be undertaken using suitable equipment and the machine must be horizontal. Check how much the machine weighs before choosing the lifting tool. During this operation, do not allow anyone to stand under the load.

##### • Handling

The generously-sized lifting eyes are for handling the alternator only. They must not be used to lift the genset. The choice of lifting hooks or handles should be determined by the shape of the lifting eyes. Choose a lifting system which respects the integrity and the environment of the machine.

During this operation, do not allow anyone to stand under the load.

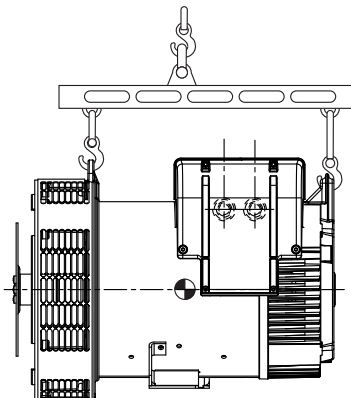

#### WARNING

After handling the machine using the lifting ring, snap on the plastic cover provided in the maintenance manual wallet.

##### • Single-bearing coupling

Before coupling, check the compatibility between the alternator and the engine by performing:

- undertaking a torsional analysis of the transmission (alternators data are available on request),
- checking the dimensions of the flywheel and its housing, the flange, coupling discs and offset.

#### WARNING

When coupling the alternator to the prime mover, do not use the fan to turn the alternator or rotor.

The holes of the coupling discs should be aligned with the flywheel holes by cranking the engine.

Make sure the machine is securely bedded in position during coupling.

Check that there is lateral play on the crankshaft.

##### • Location

The location where the alternator is placed must be ventilated to ensure that the ambient temperature cannot exceed the data on the nameplate.

# TAL 040

## Low Voltage Alternator - 4 pole

### 3.2 - Checks prior to first use

#### • Electrical checks



**Under no circumstances should an alternator, new or otherwise, be operated if the insulation is less than 1 megohm for the stator and 100,000 ohms for the other windings.**

There are 2 possible methods for restoring the above minimum values.

a) Dry out the machine for 24 hours in a drying oven at a temperature of 110 °C (without the regulator).

b) Blow hot air into the air intake, having made sure that the machine is rotating with the exciter field disconnected.

#### **Note : Prolonged standstill**

In order to avoid these problems, we recommend the use of space heaters, as well as turning over the machine from time to time. Space heaters are only really effective if they are working continuously while the machine is stopped.

**WARNING**

**Ensure that the alternator has the degree of protection matching the defined environmental conditions.**



**When the alternator's power output is ensured directly through cables, these must be connected before start-up.**

#### • Mechanical checks

Before starting the machine for the first time, check that:

- all fixing bolts are tight,
- the length of bolt and the tightening torque are correct,
- the cooling air is drawn in freely,
- the protective grille and housing are correctly in place,

- the standard direction of rotation is clockwise as seen from the drive end (phase rotation in order 1 - 2 - 3).

For anti-clockwise rotation, swap 2 and 3.

### 3.3 - Terminal connection diagrams

To modify the connection, change the position of the stator cables on the terminals. The winding code is specified on the nameplate.



**Any intervention on the alternator terminals during reconnection or checks should be performed with the machine stopped. In no case should the internal connections in the terminal box be subjected to stresses due to cables connected by the user.**



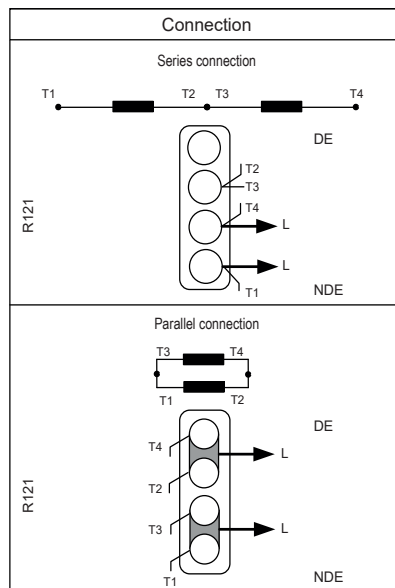

#### • SHUNT dedicated single-phase 4-wire





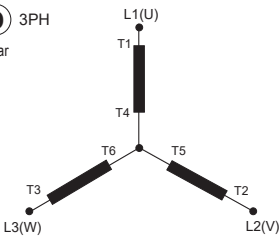
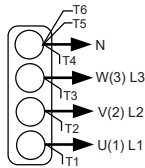

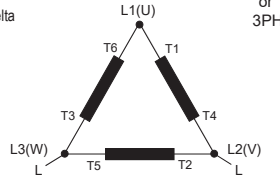
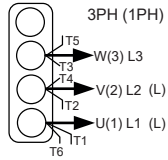
# TAL 040

## Low Voltage Alternator - 4 pole

### • SHUNT three-phase 6-wire

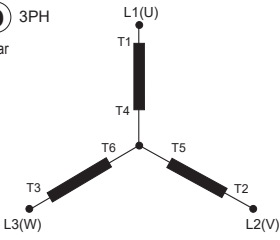
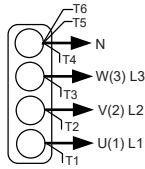
Connection codes		Voltage / Detection			Factory connection		
<b>(D)</b> 3PH Star 		Winding	50 Hz	60 Hz		DE	
		6S	380 - 415	380 - 480			
		8S	-	380 - 416			
		 <b>R120 :</b> N => T5, U => T1, V => T2			NDE		
<b>(F)</b> Delta 1PH or 3PH 		Winding	50 Hz	60 Hz			DE
		6S	220 - 240	220 - 240			
		8S	-	220 - 240			
		 <b>R120 :</b> N => T2, U => T1, V => n.c. N => N1			NDE		
 In case of reconnection, ensure that AVR voltage detection is correct!							

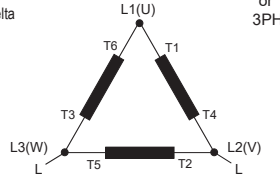
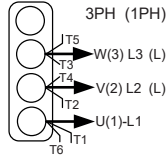
### • AREP+ three-phase 6-wire

Connection codes		Voltage / Detection			Factory connection		
<b>(D)</b> 3PH Star 		Winding	50 Hz	60 Hz		DE	
		6S	380 - 415	380 - 480			
		8S	-	380 - 416			
		 <b>R180 :</b> V => T2, W => T3			NDE		
<b>(F)</b> Delta 1PH or 3PH 		Winding	50 Hz	60 Hz			DE
		6S	220 - 240	220 - 240			
		8S	-	220 - 240			
		 <b>R180 :</b> L1 => T2, L2 => T3			NDE		
 In case of reconnection, ensure that AVR voltage detection is correct!							

# TAL 040

## Low Voltage Alternator - 4 pole

### • SHUNT or AREP+ three-phase 12-wire

Connection codes		Voltage / Detection			Factory connection	
<b>A</b> 3PH Parallel Star 	Winding	50 Hz	60 Hz			
	6	190 - 208	190 - 240			
	8	-	190 - 208			
<b>R120 :</b> N => T3, U => T1, N1 => T2, V => n.c. <b>R180 :</b> L1 => T2, L2 => T3					DE * NDE	
<b>D</b> 3PH Series Star 	Winding	50 Hz	60 Hz			
	6	380 - 415	380 - 480			
	8	-	380 - 416			
<b>R120 :</b> N => T10, U => T1, N1 => n.c., V => T2 <b>R180 :</b> V => T2, W => T3					DE * NDE	
<b>F</b> Series Delta 1PH or 3PH 	Winding	50 Hz	60 Hz			
	6	220 - 240	220 - 240			
	8	-	220 - 240			
<b>R120 :</b> N => T2, U => T1, N1 => n.c., V => n.c. <b>R180 :</b> L1 => T2, L2 => T3					DE * NDE * If counter clockwise, L2 and L3 inverted	
<b>FF</b> 1PH 	Winding	50 Hz	60 Hz			
	6	220 - 240	220 - 240			
	8	-	220 - 240			
<b>R120 :</b> N => T10, U => T1, N1 => n.c., V => n.c. <b>R180 :</b> L1 => T1, L2 => T10					DE NDE	
<b>G</b> 1PH 	Winding	50 Hz	60 Hz			
	6	220 - 240	220 - 240			
	8	-	220 - 240			
<b>R120 :</b> N => T2, U => T3, N1 => n.c., V => n.c. <b>R180 :</b> L1 => T2, L2 => T3					DE NDE	



In case of reconnection, ensure that AVR voltage detection is correct!

# TAL 040

## Low Voltage Alternator - 4 pole

### • Connection checks



**Electrical installations must comply with the current legislation in force in the country of use.**

Check that:

- The residual circuit-breaker conforms to legislation on protection of personnel, in force in the country of use, and has been correctly installed on the alternator power output as close as possible to the alternator. (In this case, disconnect the wire of the interference suppression module linking the neutral).
- Any protection devices in place have not been tripped.
- If there is an external AVR, the connections between the alternator and the cabinet are made in accordance with the connection diagram.
- There is no short-circuit phase-phase or phase-neutral between the alternator output terminals and the generator set control cabinet (part of the circuit not protected by circuitbreakers or relays in the cabinet).
- The machine should be connected with the busbar separating the terminals as shown in the terminal connection diagram.



- The alternator earth terminal inside the terminal box is connected to the electrical earth circuit
  - The earth terminal is connected to the frame.
- The connections inside the terminal box must never be subjected to stress due to cables connected by the user.



Diameter	M6	M8	M10	M12
Torque	4 Nm	10 Nm	20 Nm	35 Nm
Tolerance	± 15%			

### 3.4 - Commissioning



**The machine can only be started up and used if the installation is in accordance with the regulations and instructions defined in this manual.**

The machine is tested and set up at the factory. When first used with no load, make sure that the drive speed is correct and stable (see the nameplate).

On application of the load, the machine should achieve its rated speed and voltage; however, in the event of abnormal operation, the machine setting can be altered (follow the adjustment procedure in section 3.5). If the machine still operates incorrectly, the cause of the malfunction must be located (see section 4.5).

### 3.5 - Setting up



**The various adjustments during tests must be made by a qualified engineer. Ensure that the drive speed specified on the nameplate is reached before commencing adjustment. After operational testing, replace all access panels or covers. The AVR is used to make any adjustments to the machine.**

# TAL 040

## Low Voltage Alternator - 4 pole

### 4 - SERVICING - MAINTENANCE

#### 4.1 - Safety measures

Servicing or troubleshooting must be carried out strictly in accordance with instructions so as to avoid the risk of accidents and to maintain the machine in its original state.



All such operations performed on the alternator should be undertaken by personnel trained in the commissioning, servicing and maintenance of electrical and mechanical components, who must wear personal protective equipment appropriate for mechanical and electrical hazards.

Before any intervention on the machine, ensure that it cannot be started by a manual or automatic system and that you have understood the operating principles of the system.



**Warning :** During and after running, the alternator will reach temperatures hot enough to cause injury, such as burns.

#### 4.2 - Routine maintenance

##### • Checks after start-up

After approximately 20 hours of operation, check that all fixing bolts on the machine are still tight, plus the general state of the machine and the various electrical connections in the installation.

##### • Electrical servicing

Commercially-available volatile degreasing agents can be used.

### WARNING

**Do not use:** trichlorethylene, perchlorethylene, trichloroethane or any alkaline products.



**These operations must be performed at a cleaning station, equipped with a vacuum system that collects and flushes out the products used.**

The insulating components and the impregnation system are not at risk of damage from solvents. Avoid letting the cleaning product run into the slots.

Apply the product with a brush, sponging frequently to avoid accumulation in the housing. Dry the winding with a dry cloth. Let any traces evaporate before reassembling the machine.

##### • Mechanical servicing

### WARNING

**Cleaning the machine using water or a highpressure washer is strictly prohibited. Any problems arising from such treatment are not covered by our warranty.**

**Degreasing:** Use a brush and detergent (suitable for paintwork).

**Dusting:** Use an air gun.

If the machine is fitted with air inlet and outlet filters, the maintenance personnel should clean them routinely at regular intervals. In the case of dry dust, the filter can be cleaned using compressed air and/or replaced if it is clogged.

After cleaning the alternator, it is essential to check the winding insulation (see sections 3.2 and 4.5).

# TAL 040

## Low Voltage Alternator - 4 pole

### 4.3 - Bearings

The bearings are permanently greased	Approximate life of the grease (depending on use) = 20,000 hours or 3 years.
--------------------------------------	--

### 4.4 - Mechanical defects

Fault		Action
Bearing	Excessive overheating of one or both bearings (bearing temperature 80°C above the ambient temperature)	<ul style="list-style-type: none"> <li>- If the bearing has turned blue or if the grease has turned black, change the bearing.</li> <li>- Bearing not fully locked (abnormal play in the bearing cage)</li> <li>- End shields incorrectly aligned</li> </ul>
Abnormal temperature	Excessive overheating of alternator frame (more than 40° C above the ambient temperature)	<ul style="list-style-type: none"> <li>- Air flow (inlet-outlet) partially clogged or hot air is being recycled from the alternator or engine</li> <li>- Alternator operating at too high a voltage (&gt;105% of Un on load)</li> <li>- Alternator overloaded</li> </ul>
Vibrations	Too much vibration	<ul style="list-style-type: none"> <li>- Misalignment (coupling)</li> <li>- Defective mounting or play in coupling</li> <li>- Rotor balancing fault (Engine - Alternator)</li> </ul>
	Excessive vibration and humming noise coming from the machine	<ul style="list-style-type: none"> <li>- Phase imbalance</li> <li>- Stator short-circuit</li> </ul>
Abnormal noise	Alternator damaged by a significant impact, followed by humming and vibration	<ul style="list-style-type: none"> <li>- System short-circuit</li> <li>- Misparalleling</li> </ul> <p>Possible consequences</p> <ul style="list-style-type: none"> <li>- Broken or damaged coupling</li> <li>- Broken or bent shaft end</li> <li>- Shifting and short-circuit of main field</li> <li>- Fan fractured or coming loose on shaft</li> <li>- Irreparable damage to rotating diodes/AVR, surge suppressor</li> </ul>



# TAL 040

## Low Voltage Alternator - 4 pole

### 4.5 - Electrical faults

Fault	Action	Effect	Check/Cause
No voltage at no load on start-up	Connect a new battery of 4 to 12 volts to terminals F1 and F2, respecting the polarity, for 2 to 3 seconds	The alternator builds up and its voltage is still correct when the battery is removed	- Lack of residual magnetism
		The alternator builds up but its voltage does not reach the rated value when the battery is removed	- Check the connection of the voltage reference to the AVR - Faulty diodes - Armature short-circuit
		The alternator builds up but its voltage disappears when the battery is removed	- Faulty AVR - Field windings open circuit (check winding) - Revolving field coil open circuit (check the resistance)
Voltage too low	Check the drive speed	Correct speed	Check the AVR connections (AVR may be faulty) - Field windings short-circuited - Rotating diodes burnt out - Revolving field coil short-circuited (check the resistance)
		Speed too low	Increase the drive speed (do not touch the AVR voltage pot. before running at the correct speed)
Voltage too high	Adjust AVR voltage potentiometer	Adjustment ineffective	- Faulty AVR
Voltage oscillations	Adjust the AVR stability potentiometer		- Check the speed: possibility of cyclic irregularity - Loose connections - Faulty AVR - Speed too low when on load
Voltage correct at no load and too low when on load (*)	Run at no load and check the voltage between F1 and F2 on the AVR	Voltage between F1 and F2 SHUNT < 6V - AREP+ < 10V	- Check the speed
		Voltage between F1 and F2 SHUNT > 10V - AREP+ > 15V	- Faulty rotating diodes - Short-circuit in the revolving field coil (check the resistance) - Faulty exciter armature (check the resistance)
Voltage disappears during operation	Check the AVR, the surge suppressor, the rotating diodes, and replace any defective components	The voltage does not return to the rated value	- Exciter winding open circuit - Faulty exciter armature - Faulty AVR - Revolving field coil open circuit or short-circuited

(\*) During single-phase operation, check that the sensing wires from the AVR are connected to the correct output terminals.

# TAL 040

## Low Voltage Alternator - 4 pole

### • Checking the winding

You can check the winding insulation by performing a high voltage test. In this case, you must disconnect all AVR wires.

### WARNING

Damage caused to the AVR in such conditions is not covered by our warranty.

### • Checking the diode bridge

A diode in good working order should allow the current to flow only in the anode-to-cathode direction.

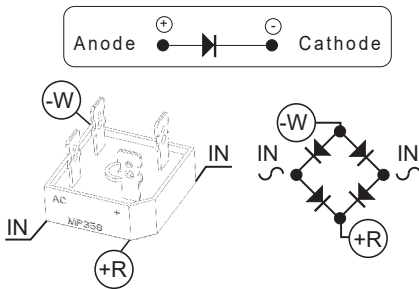

### • Checking the windings and rotating diodes using separate excitation



During this procedure, make sure that the alternator is disconnected from any external load and inspect the terminal box to check that the connections are fully tightened.

1) Stop the unit, disconnect and isolate the AVR wires.

2) There are two ways of creating an assembly with separate excitation.

**Assembly A:** Connect a 12 V battery in series with a rheostat of approximately 50 ohms - 300 W and a diode on both exciter field wires (5+) and (6-).

ASSEMBLY A

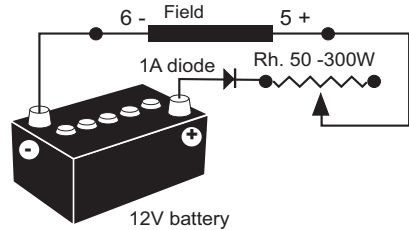

**Assembly B:** Connect a "Variac" variable power supply and a diode bridge on both exciter field wires (5+) and (6-).

Both these systems should have characteristics which are compatible with the field excitation power of the machine (see the nameplate).

3) Run the unit at its rated speed.

4) Gradually increase the exciter field current by adjusting the rheostat or the variac and measure the output voltages on L1 - L2 - L3, checking the excitation voltage and current at no load (see the machine nameplate or ask for the factory test report). When the output voltage is at its rated value and balanced within 1% for the rated excitation level, the machine is in good working order. The fault therefore comes from the AVR or its associated wiring (ie. sensing, auxiliary windings).

ASSEMBLY B

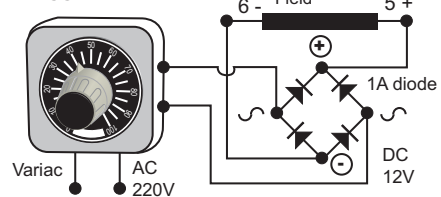

# TAL 040

## Low Voltage Alternator - 4 pole

### 4.6 - Dismantling, reassembly

#### WARNING

During the warranty period, this operation should only be carried out in an approved workshop or in our factory, otherwise the warranty may be invalidated.

Whilst being handled, the machine should remain horizontal (rotor not locked in position). Check how much the alternator weighs before choosing the lifting method.

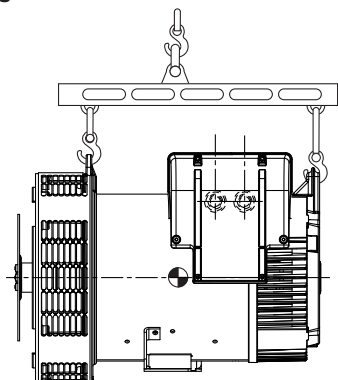

#### • Tools required

To fully dismantle the machine, we recommend using the tools listed below:

- 1 ratchet spanner + extension
- 1 torque wrench
- 1 set of flat spanners: 8 mm, 10 mm, 12 mm
- 1 socket set: 8, 10, 13 mm
- 1 socket TORX bit T20 and T30
- 1 puller (eg. Facom: U35, U32/350)

#### • Screw tightening torque

See section 5.4.



The screws for fixing the feet on the housing and immobilising the stator must not be removed (screw of the stator lower).

#### • Access to connections and the regulation system

Access is directly after removing the terminal box panel (41).

#### • Accessing, checking and replacing the diode bridge

##### Dismantling

- Remove the terminal box panel (41).
- Cut the fixing clamps of the exciter cables, remove the connector from the exciter.
- Remove the nuts on the tie rods (37).
- Remove the NDE bracket (36) using a puller: eg. U.32 - 350 (Facom).
- Unsolder the connections.
- Check the bridge using an ohmmeter or a battery lamp.

##### Reassembly

- Replace the bridges, respecting the polarity.
- Resolder the connections.
- Refit the NDE bracket and pass the bundle of wires between the top bars of the bracket.
- Replace the fixing clamps on the cables.
- Replace the terminal box panel (41).

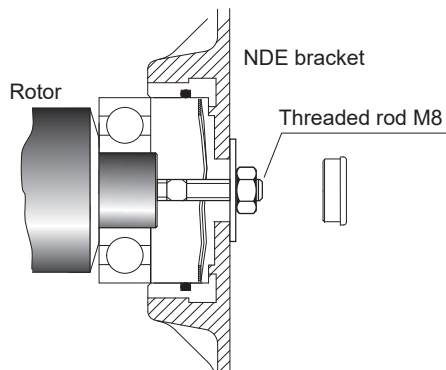

# TAL 040

## Low Voltage Alternator - 4 pole

### • Replacing the NDE bearing on single bearing machines

#### Dismantling

- Remove the NDE bracket (36).
- Remove the ball bearing (70) using a screw puller.

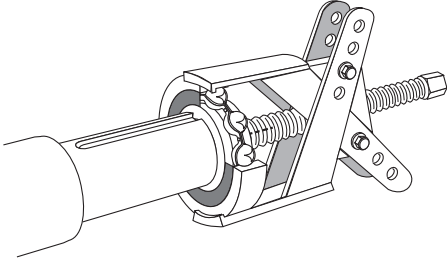

#### Reassembly

- Heat the inner slipping of a new bearing by induction or in a drying oven at 80 °C (do not use an oil bath) and fit it to the alternator.
- Place the preloading wavy washer (79) in the bracket.
- Replace the NDE bracket (36).

### • Accessing the revolving field coil and stator

#### Dismantling

Follow the procedure for dismantling bearings.

- Remove the coupling discs and insert a tube of the corresponding diameter on the shaft end or a support made according the following bellow.

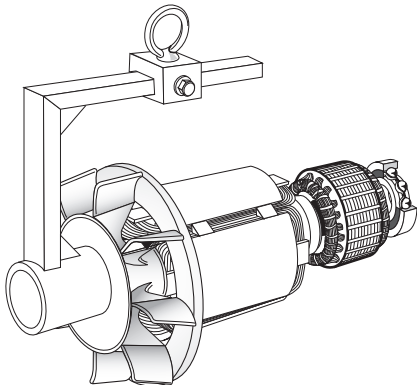

- Rest the rotor on one of its poles, then slide it out. Use the tube as a lever arm to assist dismantling.

- After extracting the rotor, be careful not to damage the fan and place the revolving field on special V-shaped supports.

In the event of disassembly of this one, it is imperative to replace it.

**NOTE: If intervention is required on the revolving field coil (rewinding, replacement of components), the rotor assembly must be rebalanced.**

#### Reassembling the revolving field coil

- Follow the dismantling procedure in reverse order.

Take care not to knock the windings when refitting the rotor in the stator.

- If you replace the fan, respect the assembly guide according the following bellow. Use a tube and a screw.

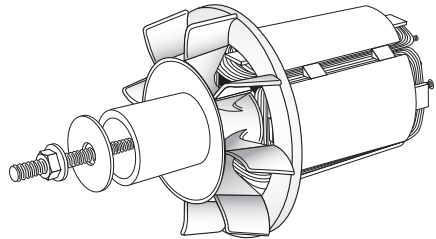

Follow the procedure for reassembling the bearings.

# TAL 040

## Low Voltage Alternator - 4 pole

### 4.7 - Table of characteristics

Table of average values:

Alternator - 4 pole - 50 Hz - Standard winding No. 6S (6-wire) and M (4-wire) connected in dedicated single-phase (400 V for the excitation values).

The voltage and current values are given for no-load operation and operation at rated load with separate field excitation.

All values are given to within  $\pm 10\%$  and may be changed without prior notification (for exact values, consult the test report).

For 60 Hz machines, the "i exc" values are approximately 5 to 10 % lower.

#### • Three-phase: 4-pole SHUNT excitation

##### Resistances at 20 °C ( $\Omega$ )

Type	Stator L/N	Rotor	Exciter field	Exciter armature
B-C	0.654	2.96	12.33	1.64
D	0.423	3.45	12.33	1.64
E	0.347	3.77	12.33	1.64
F	0.285	4.31	12.33	1.64

#### Field excitation current i exc (A)

##### 400V - 50 Hz

"i exc": excitation current of the exciter field

Type	No load	At rated load
B	0.77	1.94
C	0.77	2.30
D	0.76	2.05
E	0.75	2.06
F	0.72	1.95

#### • Three-phase: 4-pole AREP+ excitation

##### Resistances at 20 °C ( $\Omega$ )

Type	Stator L/N	Rotor	Exciter field	Exciter armature
B-C	0.654	2.96	6.54	1.64
D	0.423	3.45	6.54	1.64
E	0.347	3.77	6.54	1.64
F	0.285	4.31	6.54	1.64

##### Resistance of auxiliary windings at 20 °C ( $\Omega$ )

Type	X1, X2	Z1, Z2
B-C	0.565	0.469
D	0.456	0.333
E	0.420	0.356
F	0.407	0.385

#### Field excitation current i exc (A)

##### 400V - 50 Hz

"i exc": excitation current of the exciter field

Type	No load	At rated load
B	1.06	2.65
C	1.06	3.14
D	1.03	2.79
E	1.03	2.80
F	0.98	2.66

# TAL 040

## Low Voltage Alternator - 4 pole

### • Dedicated single-phase M: 4-pole SHUNT excitation

#### Resistances at 20 °C ( $\Omega$ ) - Series connection

Type	Stator L/N	Rotor	Exciter field	Exciter armature
C	0.149	2.96	12.33	1.64
C1	0.114	3.24	12.32	1.64
D	0.097	3.45	12.33	1.64
E	0.081	3.77	12.33	1.64
F	0.068	4.31	12.33	1.64

#### Field excitation current $i_{exc}$ (A) 230V - 50 Hz

" $i_{exc}$ ": excitation current of the exciter field

Type	No load	At rated load
C	0.77	2.02
C1	0.77	1.84
D	0.77	1.75
E	0.75	1.69
F	0.71	1.54

### • Table of weights

(values given for information only)

#### Three-phase: SHUNT/AREP+

Type	Total weight (kg)	Rotor (kg)
B	73	27
C	73	27
D	87	31
E	92	33
F	102	36

#### Dedicated single-phase M: SHUNT

Type	Total weight (kg)	Rotor (kg)
C	73	27
C1	80	29
D	87	31
E	92	33
F	102	36



**After operational testing, it is essential to replace all access panels or covers.**

# TAL 040

## Low Voltage Alternator - 4 pole

### 5 - SPARE PARTS

#### 5.1 - First maintenance parts

Here is the list of parts:

<b>Single bearing kit</b>	<b>5065809</b>
Non drive end bearing RLT025ET030 Preloading (wavy) washer	
<b>Diode bridge with integrated varistor</b>	<b>4659918</b>
before serial number 324878	
<b>Diode bridge</b>	<b>5013394</b>
after serial number 324878	
<b>AVR SHUNT R120</b>	<b>4969966</b>
<b>AVR AREP+ R180</b>	<b>5089747</b>

#### 5.2 - Technical support service

Our technical support service will be pleased to provide any additional information you may require.

For all spare parts orders or technical support requests, send your request to [service.epg@leroy-somer.com](mailto:service.epg@leroy-somer.com) or your nearest contact, whom you will find at [www.lrsm.co/support](http://www.lrsm.co/support) indicating the complete type of machine, its number and the information indicated on the nameplate.

Part numbers should be identified from the exploded views and their description from the parts list.

To ensure that our products operate correctly and safely, we recommend the use of original manufacturer spare parts.

In the event of failure to comply with this advice, the manufacturer cannot be held responsible for any damage.



**After operational testing, it is essential to replace all access panels or covers.**

#### 5.3 - Accessories

##### • Space heater for use when stopped

The space heater must run as soon as the alternator stops. It is installed at the rear of the machine. Its standard power is 60W with 220V or 60W with 110V on request.



**Warning: the power supply is present when the machine has stopped.**

# TAL 040

## Low Voltage Alternator - 4 pole

### 5.4 - Exploded view, parts list and tightening torque

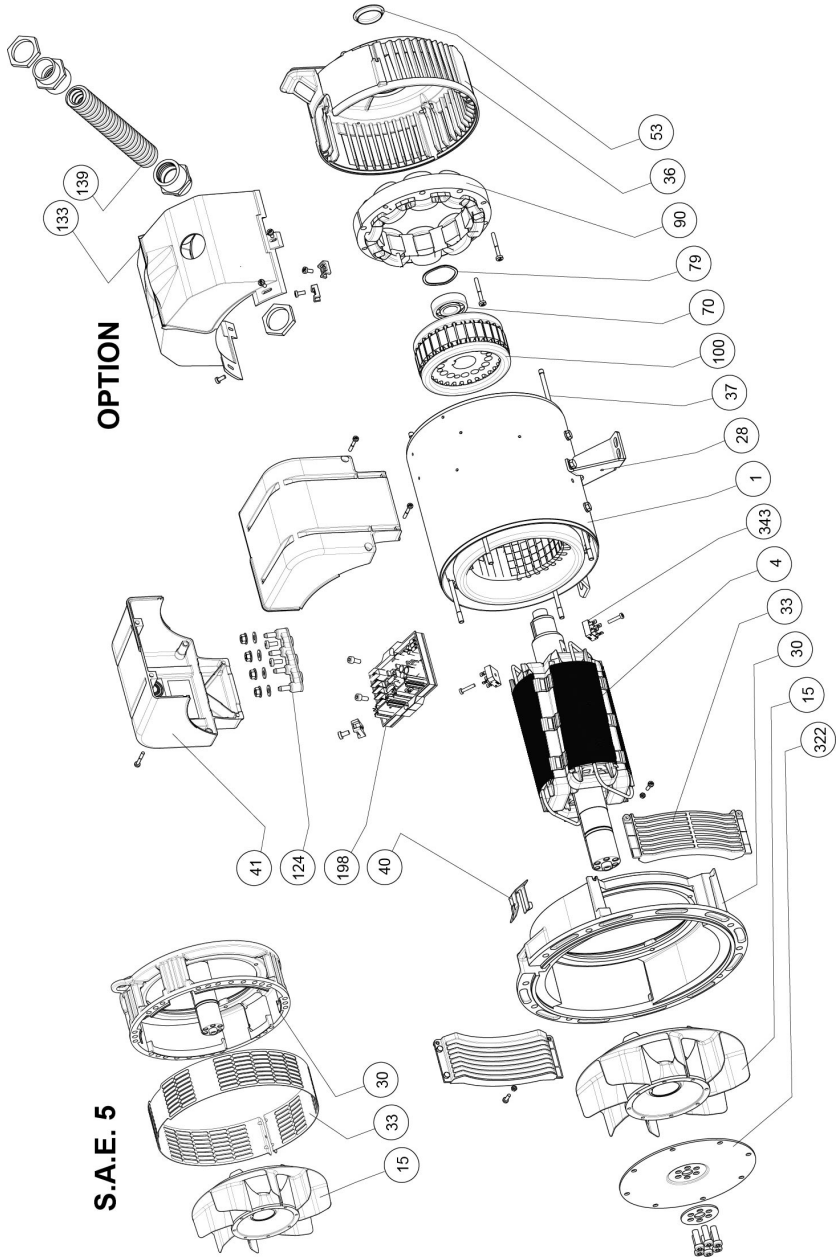



## TAL 040

### Low Voltage Alternator - 4 pole

Ref.	Qty	Description	Screw Ø	Torque N.m	Ref.	Qty	Description	Screw Ø	Torque N.m
1	1	Stator assembly	-	-	70	1	Non drive end (NDE) bearing	-	-
4	1	Rotor assembly	-	-	79	1	Preloading (wavy) washer	-	-
15	1	Fan	M5	4	90	1	Exciter field (stator)	M6	10
28	1	Earth terminal	M6	10	100	1	Exciter armature (rotor)	-	-
30	1	Drive end (DE) flange	-	-	124	1	Terminal block	-	-
33	2	Air outlet grille	M5	4	133	1	Cover (option)	M5	3.6
36	1	Non drive end (NDE) bracket	M8	20	139	1	Wire shield tube (option)	-	-
37	4	Tie rod	-	-	198	1	Voltage regulator (AVR)	M6	6
40	1	Plastic cap	-	-	322	1	Coupling disc	M10	66
41	2	Terminal box panel	M5	3.6	343	2	Diode bridge	M5	4
53	1	Sealing cap	-	-					

# TAL 040

## Low Voltage Alternator - 4 pole

### Disposal and recycling instructions

We are committed to limiting the environmental impact of our activity. We continuously monitor our production processes, material sourcing and product design to improve recyclability and minimise our environmental footprint.

These instructions are for information purposes only. It is the user's responsibility to comply with local legislation regarding product disposal and recycling.

### Recyclable materials

Our alternators are mainly constructed from iron, steel and copper materials, which can be reclaimed for recycling purposes.

These materials can be reclaimed through a combination of manual dismantling, mechanical separation and melting processes. Our technical support department can provide detailed directions on how to dismantle products on request.

### Waste & hazardous materials

The following components and materials require special treatment and must be separated from the alternator before the recycling process:

- electronic materials found in the terminal box, including the automatic voltage regulator (198), current transformers (176), interference suppression module and other semi-conductors.
- diode bridge (343) and surge suppressor (347), found on the alternator rotor.
- major plastic components, such as the terminal box structure on some products. These components are usually marked with information concerning the type of plastic.

All materials listed above need special treatment to separate waste from reclaimable materials and should be entrusted to specialist recycling companies.

The oil and grease from the lubrication system should be treated as hazardous waste and must be treated in accordance with local legislation.

Our alternators have a specified lifetime of 20 years. After this period, the operation of the product should be stopped, regardless of its condition. Any further operation after this period will be under the sole responsibility of the user.

# TAL 040

## Low Voltage Alternator - 4 pole

# TAL 040

## Low Voltage Alternator - 4 pole

# TAL 040

## Low Voltage Alternator - 4 pole



**Moteurs Leroy-Somer**  
Boulevard Marcellin Leroy - CS 10015  
16915 Angoulême cedex 9 - France

Angoulême, 28 October 2021

### EC Declaration

Moteurs Leroy-Somer declares hereby that the electric generators of the types:  
LSA 40 – LSA 42.3 – LSA 44.3 – LSA 46.3 – LSA 47.2 – LSA 47.3 – LSA 49.1 – LSA 49.3 – LSA 50.1 –  
LSA 50.2 – LSA 51.2 – LSA 52.2 – LSA 52.3 – LSA 53 – LSA 53.1 – LSA 53.2 – LSA 54 – LSA 54.2 – TAL  
040 – TAL 042 – TAL 044 – TAL 046 – TAL 047 – TAL 0473 – TAL 049 – LSAH 42.3 – LSAH 44.3  
as well as their derivatives, manufactured by Leroy-Somer or on Leroy-Somer's behalf:

**MOTEURS LEROY-SOMER**  
Boulevard Marcellin Leroy  
16015 Angoulême  
France

**MLS HOLICE STLO.SRO**  
Sladkovskeho 43  
772 04 Olomouc  
République Tchèque

**MOTEURS LEROY-SOMER**  
1, rue de la Burelle  
Boite Postale 1517  
45800 St Jean de Braye France

**LEROY-SOMER ELECTRO-  
TECHNIQUE Co., Ltd**  
No1 Aimosheng Road, Galshan Town,  
Cangshan District,  
Fuzhou, Fujian 350026 Chine

**NIDEC INDUSTRIAL AUTOMATION  
INDIA PRIVATE Ltd - BANGALORE**  
#45, Nagarur, Huskur Road  
Off Tumkur Road,  
Bengaluru-562 162 Inde

**NIDEC INDUSTRIAL AUTOMATION  
INDIA PRIVATE Ltd - HUBLI**  
#64/A, Main Road,  
Tarihal IndustrialArea,  
Tarihal, Hubli-580 026 Inde

meet the requirements of the following standards and directives:

#### Declaration of compliance:

- Low Voltage Directive Nr 2014/35/EU dated 26<sup>th</sup> February 2014.
- EN and IEC 60034-1, 60034-5 and 60034-22.
- ISO 8528-3 "Reciprocating internal combustion engine driven alternating current generating sets. Part 3. Alternating current generators for generating sets".

These generators also comply with the ROHS Directive Nr 2011/65/EU dated 8<sup>th</sup> June 2011 and its Annex II Nr 2015/863 dated 31<sup>st</sup> March 2015, as well as the EMC Directive Nr 2014/30/EU dated 26<sup>th</sup> February 2014.

#### Declaration of incorporation:

These generators are designed to meet the essential requirements Annex I, chapters 1.1.2, 1.1.3, 1.1.5, 1.3.1 to 1.3.3, 1.3.6 to 1.3.8.1, 1.4.1, 1.4.2.1, 1.5.2 to 1.5.11, 1.5.13, 1.6.1, 1.6.4, 1.7 (except 1.7.1.2) of Machinery Directive Nr 2006/42/EC, as well as Annex VII, part B of this directive and the aforementioned standards.

As a result, these "Partly completed machinery" are designed to be incorporated into Electrical Gen-Sets complying with the Machinery Directive Nr 2006/42/EC dated 17<sup>th</sup> May 2006.

#### WARNING:

The here mentioned generators should not be commissioned until the corresponding Gen-Sets have been declared in compliance with the Directives Nr 2006/42/EC, 2014/30/EU, 2011/65/EU and 2015/863, as well as with other relevant Directives.

Moteurs Leroy-Somer undertakes to transmit, in response to a reasoned request by the national authorities, relevant information on the generator.

Those responsible for compiling the technical files and this declaration are:  
Yannick MESSIN, Technical Manager LS Orléans, 1 rue de la Burelle, 45800 Saint Jean de Braye  
Jean-Pierre CHARPENTIER, Technical Manager LS Sillac, Bld Marcellin Leroy, 16015 Angoulême

J.P. CHARPENTIER – Y. MESSIN

**LEROY-SOMER**<sup>™</sup>

**Moteurs Leroy-Somer**

Headquarters: Boulevard Marcellin Leroy CS 10015 - 16915 Angoulême cedex 9 - France  
SAS with share capital of 38,679,664 € - RCS Angoulême 338 567 258

4152 en - 2021.10 / v

*The contractual EC Declaration of compliance and incorporation can be obtained from your contact on request.*

# TAL 040

## Low Voltage Alternator - 4 pole

# Service & Support

Our worldwide service network of over 80 facilities is at your service.

This local presence is our guarantee for fast and efficient repair, support and maintenance services.

Trust your alternator maintenance and support to electric power generation experts. Our field personnel are 100% qualified and fully trained to operate in all environments and on all machine types.

We have a deep understanding of alternator operation, providing the best value service to optimise your cost of ownership.

Where we can help:

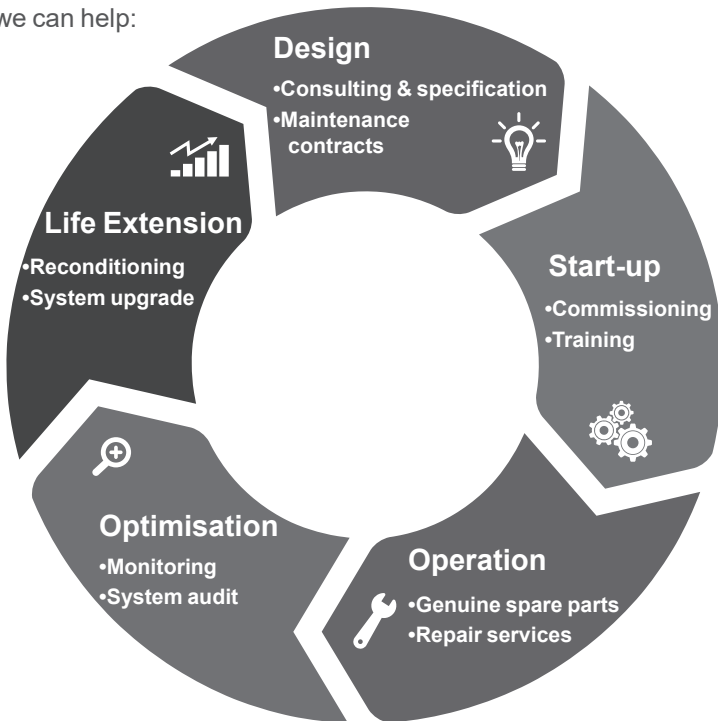

Contact us:

**Americas:** +1 (507) 625 4011

**EMEA:** +33 238 609 908

**Asia Pacific:** +65 6250 8488

**China:** +86 591 8837 3010

**India:** +91 806 726 4867



Scan the code or go to:

 [service.epg@leroy-somer.com](mailto:service.epg@leroy-somer.com)

[www.lrsom.co/support](http://www.lrsom.co/support)

**LEROY-SOMER**<sup>TM</sup>

[www.leyoy-somer.com/epg](http://www.leyoy-somer.com/epg)

Connect with us at:



***Nidec***  
All for dreams