

1220-0020020 - DBR3, 2000W, 20R, TS - BRAKING RESISTOR

This resistor is made with coiled coil elements inside a metallic framework. The frame of the enclosure is made of galvanized steel with IP20 degree of protection. The power terminals are available on a clamp and are located within the lid, which can be opened for electrical connection. The box is equipped with thermal pad with proper terminal in the lid.

1. Electrical parameters

Parameter	Value	UM	Condition
Resistance	20 ±10%	Ω	@ 20°C
Rated Power UL	1700	W	continuous duty 100%
Rated Power CE	2000	W	
Max working voltage	800	V	
Max current	57	A	
Dielectric strength	3800	V	between terminals and ground, test according to IEC 61439
Energy absorption	105	kJ	for not repetitive pulses with duration < 1 s
Operating temperature	- 25 °C ÷ + 60 °C		Stocking temp. - 25 °C ÷ + 70 °C
Max surrounding temperature +40°C (UL rating requirement)			

2. Thermal performance

The temperature of the resistor depends on the power that it will dissipate. The UL rated power value indicated in this data sheet refers to a temperature on the upper wall of about 200°C. The CE rated power indicated in this datasheet refers to a temperature of the wire around 600 °C. In the graph on the right it's indicated the relationship between the power and the temperature of the resistive wire.

Derating: due to ambient temperature the rated power is reduced to zero linearly starting from 40 to 220 °C

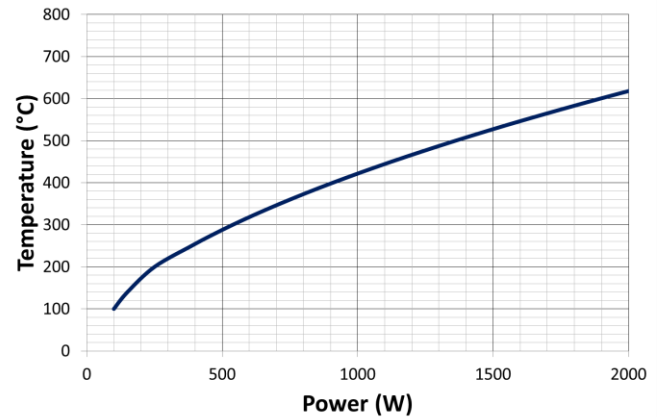

3. Cyclic work

The resistor can be overloaded with respect to its nominal power based on the working cycle (insertion and rest time).

In the table below it is indicated the braking power (kW) that is possible to supply to the resistor during the cyclic load.

Period time	ED = 6%	ED = 10%	ED = 25%
30 s	33	20	8
60 s	27	18	8
120 s	20	12	6
240 s	13	8	6

4. Marking

Each resistor is labelled with this information:

- Name of the product and part number
- Ohmic value and tolerance
- Degree of protection IP
- Rated power UL and CE
- UL file nr.
- Order number
- Batch of production in the format WW/YY where WW means week and YY year

5. Installation

- Allowed mounting positions are shown in the pictures on the right.
- The terminals should always be kept low to avoid heating during the working of the resistance.
- The resistor is provided with 4 slots for screws max M6, not included in the resistor.
- The use of the appropriate screws and washers and its torqueing clamp is at user's responsibility.
- In order to assure the correct thermal behaviour of the unit, it's recommended to keep at least 100 mm between two consecutive resistors and 150 mm of free space on the top, see fig. 4 for reference.
- If the power connection is kept low it also secures the optimal position of the thermal switch.

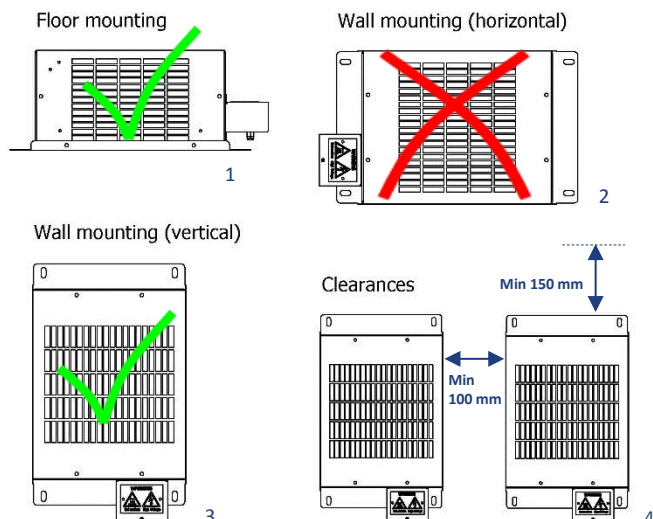

1220-0020020 - DBR3, 2000W, 20R, TS - BRAKING RESISTOR

6. Safety instruction

- The thermal switch should preferably power down the inverter.
- Never operate with the terminal cover removed, hazard risk of serious injury because of dangerous voltage.
- Never touch the resistor enclosure, the temperature of the enclosure can be very hot and dangerous.
- Never supply the resistor over the limits indicated in the par. 1 and 3, the resistor might burn.
- Never insert parts through the resistor enclosure, the resistor will always be at dangerous voltage level.
- The resistor is not protected against short circuit condition, in case the braking transistor on the inverter is close, the consequence if the current continue to flow for a time > 3 s is the burn of the resistor.
- The thermal switch operates in case of long overload of 2 / 3 times the rated power.



7. Maintenance and general care

This component is not subject to any maintenance. Nevertheless when used in a very dusty or humid environment, it should be cleaned in order to maintain its thermal and electrical characteristics. The resistor is provided inside a sealed box to protect against accidental fall. During the handling operation once the resistor is extracted from the box, it must be handle with care. Accidental fall may cause serious damages to the unit.

8. Procedure for electrical connections

1. fix the resistor in its final destination according to par.5.
2. remove the cover by unscrewing the 3 screws as shown in the Fig. 1.

power connection

3. Insert the cable gland (not provided with the resistor) in the hole diam.20 mm that is provided for cable gland M20.
4. Insert the cable into the cable gland.
5. Connect the power cable terminals to clamps BR1 and BR2, max clamping torque on the terminals is 2 Nm.
6. Torque the cable gland at the value that is specified on the cable gland datasheet provided by the manufacturer.

thermal switch connection

7. Insert the cable gland (not provided with the resistor) in the hole diam.16 mm that is provided for cable gland M16.
8. Connect the thermal switch cable terminals to clamp C1 C2, max clamping torque on the terminals is 0,45 Nm.
9. Torque the cable gland at the value that is specified on the cable gland datasheet provided by the manufacturer.
10. Close the lip by screwing 3 screws as shown in the Figure 1, max clamping torque is 1 Nm.

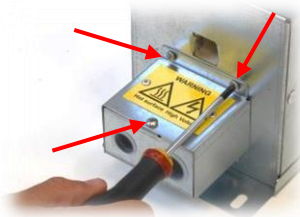

Figure 1

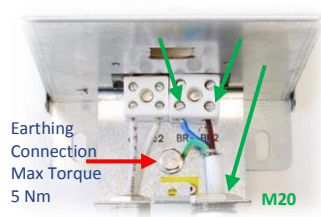

Figure 2 – power connection

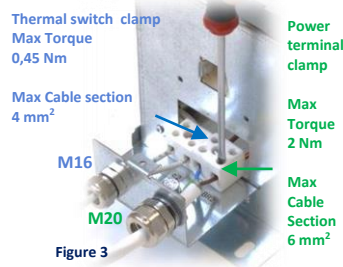

Figure 3

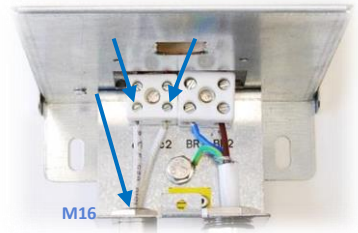
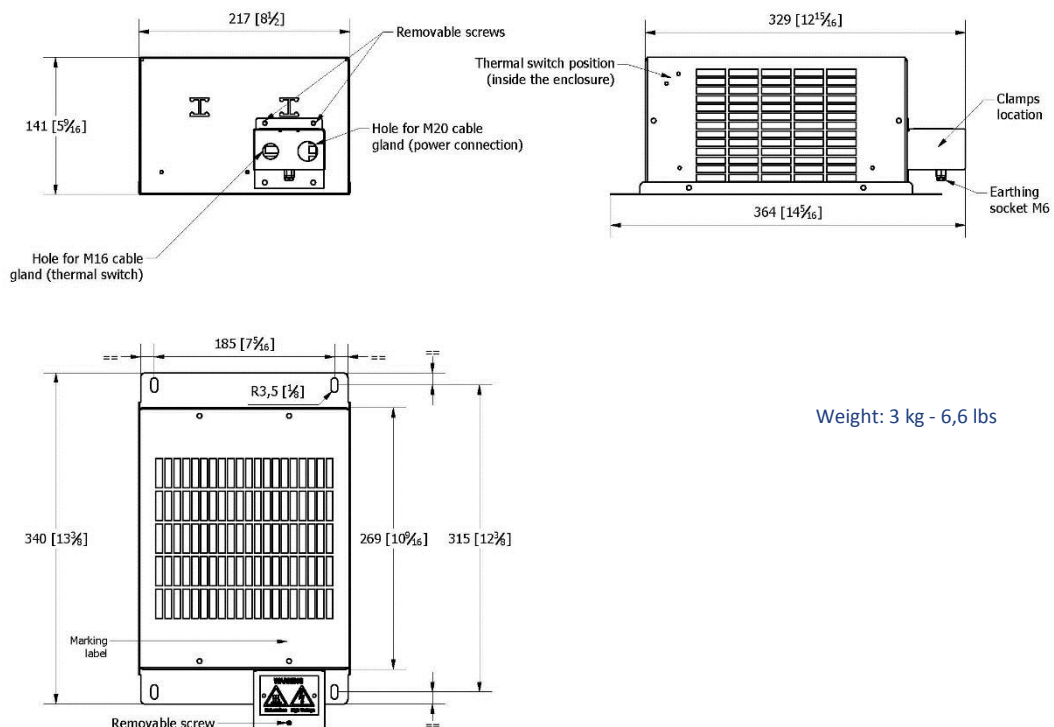

Figure 4 – thermal switch connection

9. Drawing



1220-0020100 - DBR3, 2000W, 100R, TS - BRAKING RESISTOR

This resistor is made with coiled coil elements inside a metallic framework. The frame of the enclosure is made of galvanized steel with IP20 degree of protection. The power terminals are available on a clamp and are located within the lid, which can be opened for electrical connection. The box is equipped with thermal pad with proper terminal in the lid.

1. Electrical parameters

Parameter	Value	UM	Condition
Resistance	100 ±10%	Ω	@ 20°C
Rated Power UL	1700	W	continuous duty 100%
Rated Power CE	2000	W	
Max working voltage	800	V	
Max current	57	A	
Dielectric strength	3800	V	between terminals and ground, test according to IEC 61439
Energy absorption	126	kJ	for not repetitive pulses with duration < 1 s
Operating temperature	- 25 °C ÷ + 60 °C		Stocking temp. - 25 °C ÷ + 70 °C
Max surrounding temperature +40°C (UL rating requirement)			

2. Thermal performance

The temperature of the resistor depends on the power that it will dissipate. The UL rated power value indicated in this data sheet refers to a temperature on the upper wall of about 200°C. The CE rated power indicated in this datasheet refers to a temperature of the wire around 600 °C. In the graph on the right it's indicated the relationship between the power and the temperature of the resistive wire.

Derating: due to ambient temperature the rated power is reduced to zero linearly starting from 40 to 220 °C

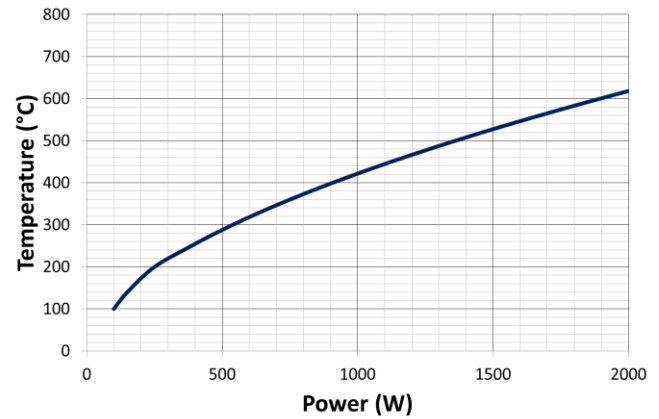

3. Cyclic work

The resistor can be overloaded with respect to its nominal power based on the working cycle (insertion and rest time).

In the table below it is indicated the braking power (kW) that is possible to supply to the resistor during the cyclic load.

Period time	ED = 6%	ED = 10%	ED = 25%
30 s	33	20	8
60 s	27	18	8
120 s	20	12	6
240 s	13	8	6

4. Marking

Each resistor is labelled with this information:

- Name of the product and part number
- Ohmic value and tolerance
- Degree of protection IP
- Rated power UL and CE
- UL file nr.
- Order number
- Batch of production in the format WW/YY where WW means week and YY year

5. Installation

- Allowed mounting positions are shown in the pictures on the right.
- The terminals should always be kept low to avoid heating during the working of the resistance.
- The resistor is provided with 4 slots for screws max M6, not included in the resistor.
- The use of the appropriate screws and washers and its torqueing clamp is at user's responsibility.
- In order to assure the correct thermal behaviour of the unit, it's recommended to keep at least 100 mm between two consecutive resistors and 150 mm of free space on the top, see fig. 4 for reference.
- If the power connection is kept low it also secures the optimal position of the thermal switch.

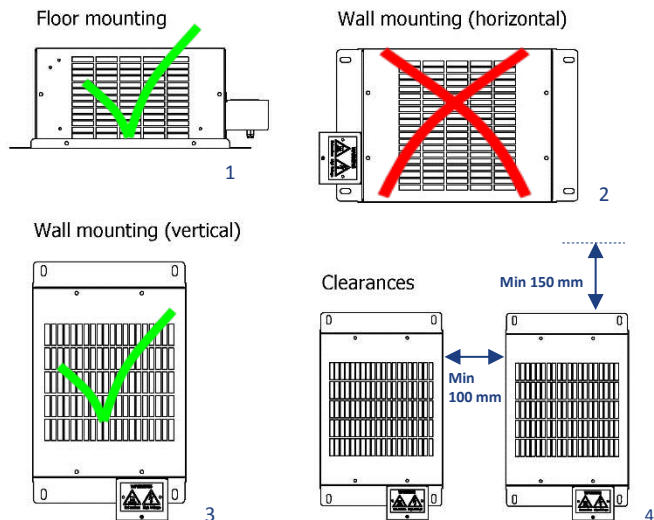

6. Safety instruction

- The thermal switch should preferably power down the inverter.
- Never operate with the terminal cover removed, hazard risk of serious injury because of dangerous voltage.
- Never touch the resistor enclosure, the temperature of the enclosure can be very hot and dangerous.
- Never supply the resistor over the limits indicated in the par. 1 and 3, the resistor might burn.
- Never insert parts through the resistor enclosure, the resistor will always be at dangerous voltage level.
- The resistor is not protected against short circuit condition, in case the braking transistor on the inverter is close, the consequence if the current continue to flow for a time > 3 s is the burn of the resistor.
- The thermal switch operates in case of long overload of 2 / 3 times the rated power.



7. Maintenance and general care

This component is not subject to any maintenance. Nevertheless when used in a very dusty or humid environment, it should be cleaned in order to maintain its thermal and electrical characteristics. The resistor is provided inside a sealed box to protect against accidental fall. During the handling operation once the resistor is extracted from the box, it must be handle with care. Accidental fall may cause serious damages to the unit.

8. Procedure for electrical connections

1. fix the resistor in its final destination according to par.5.
2. remove the cover by unscrewing the 3 screws as shown in the Fig. 1.

power connection

3. Insert the cable gland (not provided with the resistor) in the hole diam.20 mm that is provided for cable gland M20.
4. Insert the cable into the cable gland.
5. Connect the power cable terminals to clamps BR1 and BR2, max clamping torque on the terminals is 2 Nm.
6. Torque the cable gland at the value that is specified on the cable gland datasheet provided by the manufacturer.

thermal switch connection

7. Insert the cable gland (not provided with the resistor) in the hole diam.16 mm that is provided for cable gland M16.
8. Connect the thermal switch cable terminals to clamp C1 C2, max clamping torque on the terminals is 0,45 Nm.
9. Torque the cable gland at the value that is specified on the cable gland datasheet provided by the manufacturer.
10. Close the lip by screwing 3 screws as shown in the Figure 1, max clamping torque is 1 Nm.

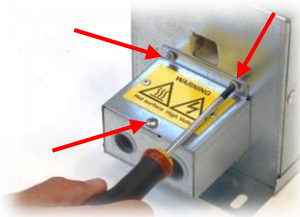

Figure 1

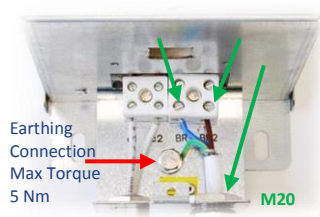

Figure 2 – power connection

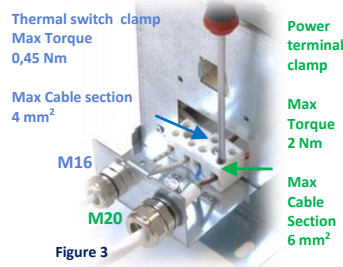

Figure 3

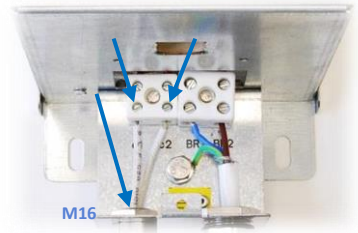
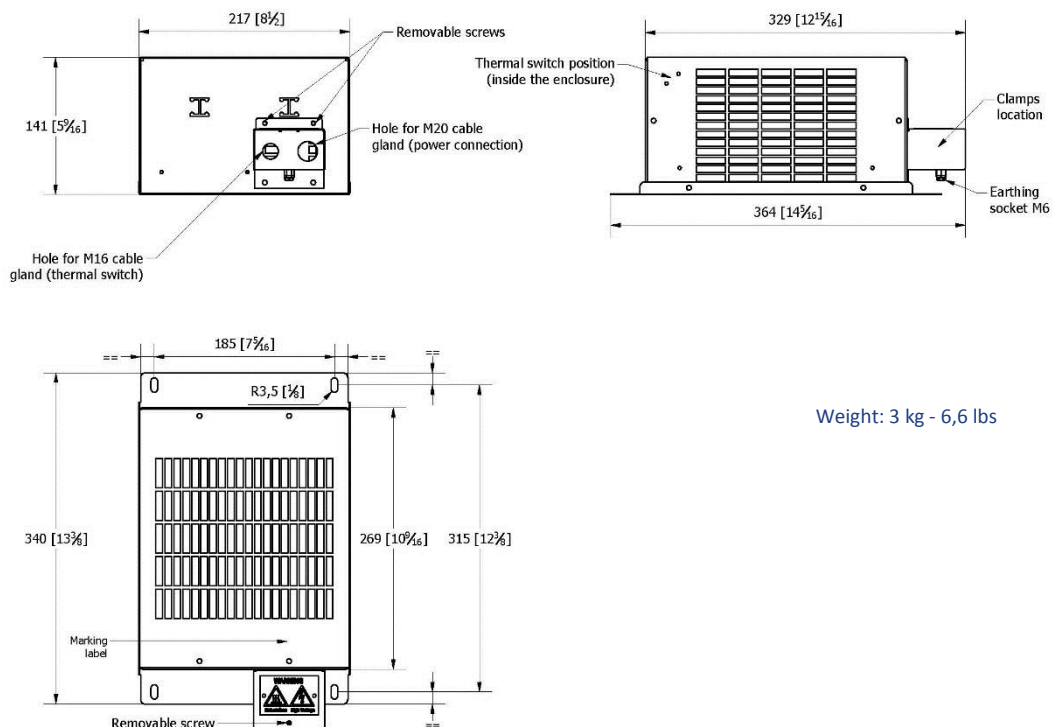

Figure 4 – thermal switch connection

9. Drawing



Weight: 3 kg - 6,6 lbs

1220-0020050 - DBR3, 2000W, 50R, TS - BRAKING RESISTOR

This resistor is made with coiled coil elements inside a metallic framework. The frame of the enclosure is made of galvanized steel with IP20 degree of protection. The power terminals are available on a clamp and are located within the lid, which can be opened for electrical connection. The box is equipped with thermal pad with proper terminal in the lid.

1. Electrical parameters

Parameter	Value	UM	Condition
Resistance	50 ±10%	Ω	@ 20°C
Rated Power UL	1700	W	continuous duty 100%
Rated Power CE	2000	W	
Max working voltage	800	V	
Max current	57	A	
Dielectric strength	3800	V	between terminals and ground, test according to IEC 61439
Energy absorption	98	kJ	for not repetitive pulses with duration < 1 s
Operating temperature	- 25 °C ÷ + 60 °C		Stocking temp. - 25 °C ÷ + 70 °C
Max surrounding temperature +40°C (UL rating requirement)			

2. Thermal performance

The temperature of the resistor depends on the power that it will dissipate. The UL rated power value indicated in this data sheet refers to a temperature on the upper wall of about 200°C. The CE rated power indicated in this datasheet refers to a temperature of the wire around 600 °C. In the graph on the right it's indicated the relationship between the power and the temperature of the resistive wire.

Derating: due to ambient temperature the rated power is reduced to zero linearly starting from 40 to 220 °C

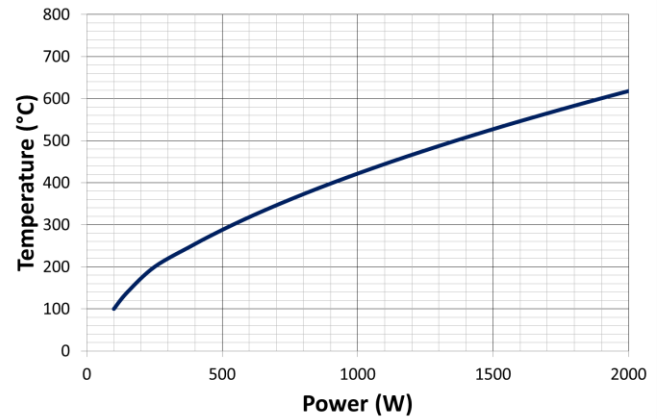

3. Cyclic work

The resistor can be overloaded with respect to its nominal power based on the working cycle (insertion and rest time).

In the table below it is indicated the braking power (kW) that is possible to supply to the resistor during the cyclic load.

Period time	ED = 6%	ED = 10%	ED = 25%
30 s	33	20	8
60 s	27	18	8
120 s	20	12	6
240 s	13	8	6

5. Installation

- Allowed mounting positions are shown in the pictures on the right.
- The terminals should always be kept low to avoid heating during the working of the resistance.
- The resistor is provided with 4 slots for screws max M6, not included in the resistor.
- The use of the appropriate screws and washers and its torqueing clamp is at user's responsibility.
- In order to assure the correct thermal behaviour of the unit, it's recommended to keep at least 100 mm between two consecutive resistors and 150 mm of free space on the top, see fig. 4 for reference.
- If the power connection is kept low it also secures the optimal position of the thermal switch.

4. Marking

Each resistor is labelled with this information:

- Name of the product and part number
- Ohmic value and tolerance
- Degree of protection IP
- Rated power UL and CE
- UL file nr.
- Order number
- Batch of production in the format WW/YY where WW means week and YY year

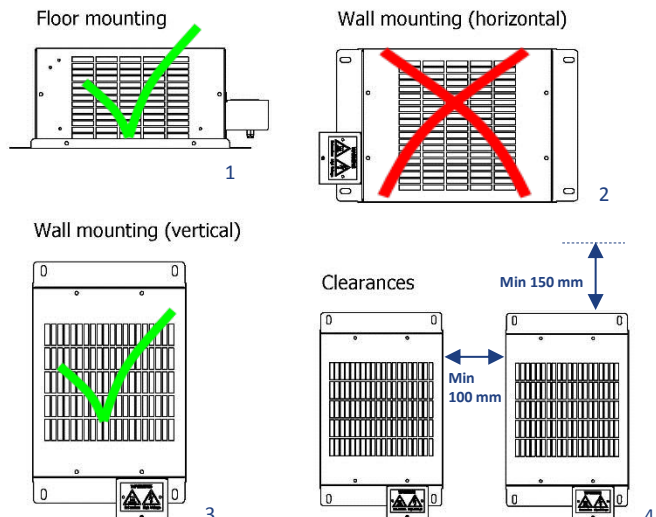

1220-0020050 - DBR3, 2000W, 50R, TS - BRAKING RESISTOR

6. Safety instruction

- The thermal switch should preferably power down the inverter.
- Never operate with the terminal cover removed, hazard risk of serious injury because of dangerous voltage.
- Never touch the resistor enclosure, the temperature of the enclosure can be very hot and dangerous.
- Never supply the resistor over the limits indicated in the par. 1 and 3, the resistor might burn.
- Never insert parts through the resistor enclosure, the resistor will always be at dangerous voltage level.
- The resistor is not protected against short circuit condition, in case the braking transistor on the inverter is close, the consequence if the current continue to flow for a time > 3 s is the burn of the resistor.
- The thermal switch operates in case of long overload of 2 / 3 times the rated power.



7. Maintenance and general care

This component is not subject to any maintenance. Nevertheless when used in a very dusty or humid environment, it should be cleaned in order to maintain its thermal and electrical characteristics. The resistor is provided inside a sealed box to protect against accidental fall. During the handling operation once the resistor is extracted from the box, it must be handle with care. Accidental fall may cause serious damages to the unit.

8. Procedure for electrical connections

1. fix the resistor in its final destination according to par.5.
2. remove the cover by unscrewing the 3 screws as shown in the Fig. 1.

power connection

3. Insert the cable gland (not provided with the resistor) in the hole diam.20 mm that is provided for cable gland M20.
4. Insert the cable into the cable gland.
5. Connect the power cable terminals to clamps BR1 and BR2, max clamping torque on the terminals is 2 Nm.
6. Torque the cable gland at the value that is specified on the cable gland datasheet provided by the manufacturer.

thermal switch connection

7. Insert the cable gland (not provided with the resistor) in the hole diam.16 mm that is provided for cable gland M16.
8. Connect the thermal switch cable terminals to clamp C1 C2, max clamping torque on the terminals is 0,45 Nm.
9. Torque the cable gland at the value that is specified on the cable gland datasheet provided by the manufacturer.
10. Close the lip by screwing 3 screws as shown in the Figure 1, max clamping torque is 1 Nm.

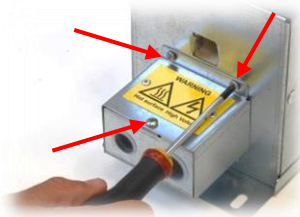

Figure 1

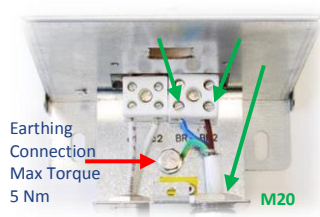

Figure 2 – power connection

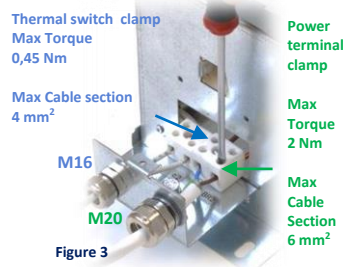

Figure 3

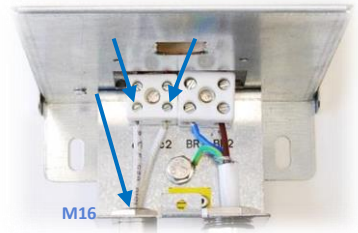
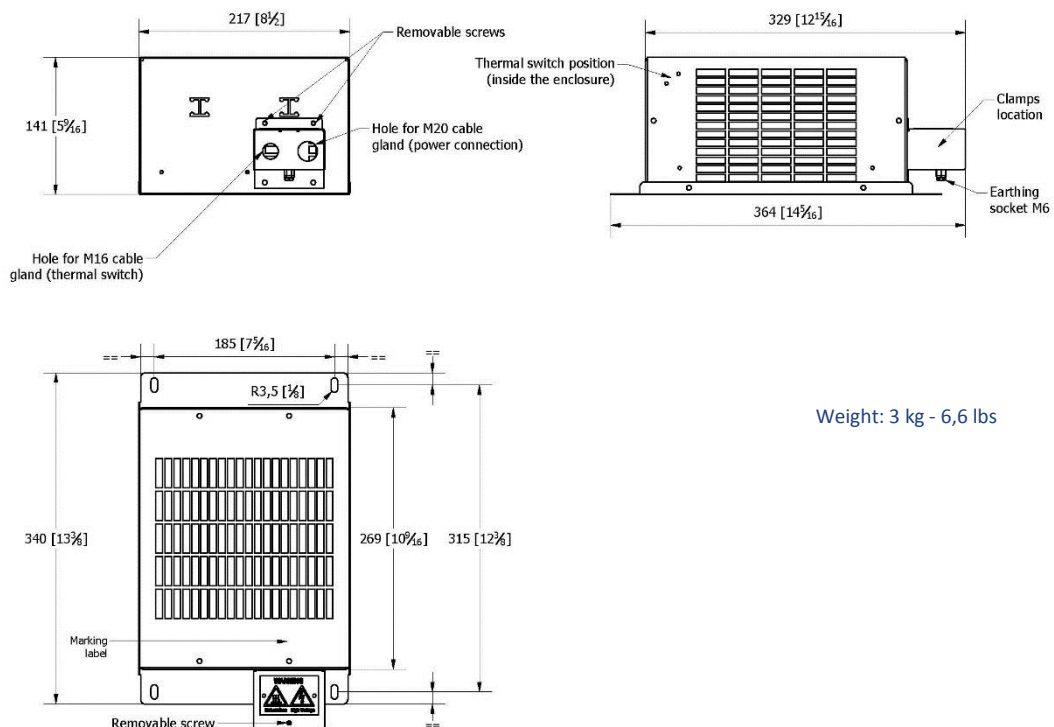

Figure 4 – thermal switch connection

9. Drawing



Weight: 3 kg - 6,6 lbs

1220-0020040 - DBR3, 2000W, 40R, TS - BRAKING RESISTOR

This resistor is made with coiled coil elements inside a metallic framework. The frame of the enclosure is made of galvanized steel with IP20 degree of protection. The power terminals are available on a clamp and are located within the lid, which can be opened for electrical connection. The box is equipped with thermal pad with proper terminal in the lid.

1. Electrical parameters

Parameter	Value	UM	Condition
Resistance	40 ±10%	Ω	@ 20°C
Rated Power UL	1700	W	continuous duty 100%
Rated Power CE	2000	W	
Max working voltage	800	V	
Max current	57	A	
Dielectric strength	3800	V	between terminals and ground, test according to IEC 61439
Energy absorption	81	kJ	for not repetitive pulses with duration < 1 s
Operating temperature	- 25 °C ÷ + 60 °C		Stocking temp. - 25 °C ÷ + 70 °C
Max surrounding temperature +40°C (UL rating requirement)			

2. Thermal performance

The temperature of the resistor depends on the power that it will dissipate. The UL rated power value indicated in this data sheet refers to a temperature on the upper wall of about 200°C. The CE rated power indicated in this datasheet refers to a temperature of the wire around 600 °C. In the graph on the right it's indicated the relationship between the power and the temperature of the resistive wire.

Derating: due to ambient temperature the rated power is reduced to zero linearly starting from 40 to 220 °C

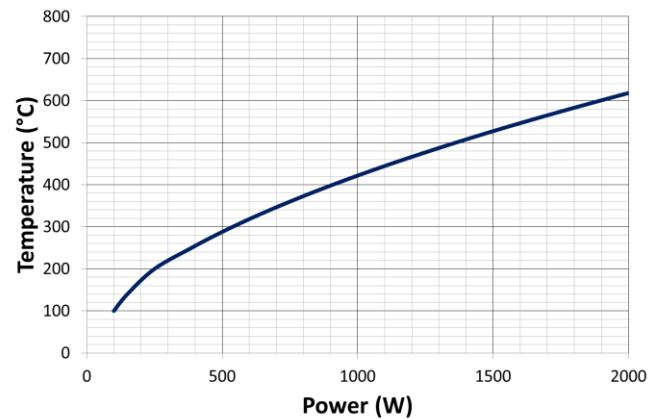

3. Cyclic work

The resistor can be overloaded with respect to its nominal power based on the working cycle (insertion and rest time).

In the table below it is indicated the braking power (kW) that is possible to supply to the resistor during the cyclic load.

Period time	ED = 6%	ED = 10%	ED = 25%
30 s	33	20	8
60 s	27	18	8
120 s	20	12	6
240 s	13	8	6

4. Marking

Each resistor is labelled with this information:

- Name of the product and part number
- Ohmic value and tolerance
- Degree of protection IP
- Rated power UL and CE
- UL file nr.
- Order number
- Batch of production in the format WW/YY where WW means week and YY year

5. Installation

- Allowed mounting positions are shown in the pictures on the right.
- The terminals should always be kept low to avoid heating during the working of the resistance.
- The resistor is provided with 4 slots for screws max M6, not included in the resistor.
- The use of the appropriate screws and washers and its torqueing clamp is at user's responsibility.
- In order to assure the correct thermal behaviour of the unit, it's recommended to keep at least 100 mm between two consecutive resistors and 150 mm of free space on the top, see fig. 4 for reference.
- If the power connection is kept low it also secures the optimal position of the thermal switch.

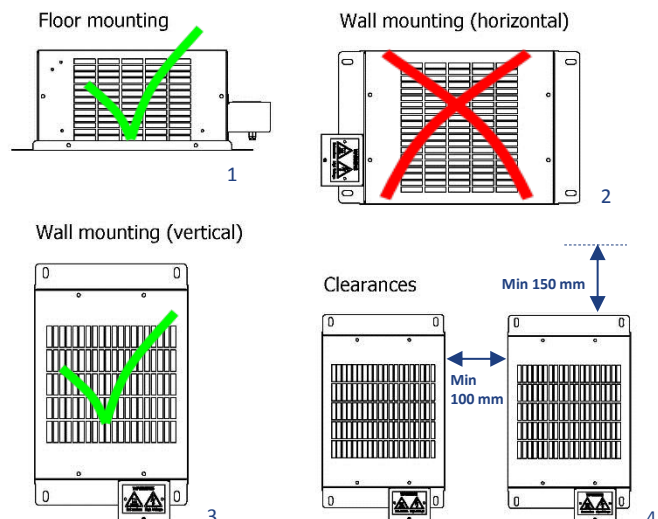

1220-0020040 - DBR3, 2000W, 40R, TS - BRAKING RESISTOR

6. Safety instruction

- The thermal switch should preferably power down the inverter.
- Never operate with the terminal cover removed, hazard risk of serious injury because of dangerous voltage.
- Never touch the resistor enclosure, the temperature of the enclosure can be very hot and dangerous.
- Never supply the resistor over the limits indicated in the par. 1 and 3, the resistor might burn.
- Never insert parts through the resistor enclosure, the resistor will always be at dangerous voltage level.
- The resistor is not protected against short circuit condition, in case the braking transistor on the inverter is close, the consequence if the current continue to flow for a time > 3 s is the burn of the resistor.
- The thermal switch operates in case of long overload of 2 / 3 times the rated power.



7. Maintenance and general care

This component is not subject to any maintenance. Nevertheless when used in a very dusty or humid environment, it should be cleaned in order to maintain its thermal and electrical characteristics. The resistor is provided inside a sealed box to protect against accidental fall. During the handling operation once the resistor is extracted from the box, it must be handle with care. Accidental fall may cause serious damages to the unit.

8. Procedure for electrical connections

1. fix the resistor in its final destination according to par.5.
2. remove the cover by unscrewing the 3 screws as shown in the Fig. 1.

power connection

3. Insert the cable gland (not provided with the resistor) in the hole diam.20 mm that is provided for cable gland M20.
4. Insert the cable into the cable gland.
5. Connect the power cable terminals to clamps BR1 and BR2, max clamping torque on the terminals is 2 Nm.
6. Torque the cable gland at the value that is specified on the cable gland datasheet provided by the manufacturer.

thermal switch connection

7. Insert the cable gland (not provided with the resistor) in the hole diam.16 mm that is provided for cable gland M16.
8. Connect the thermal switch cable terminals to clamp C1 C2, max clamping torque on the terminals is 0,45 Nm.
9. Torque the cable gland at the value that is specified on the cable gland datasheet provided by the manufacturer.
10. Close the lip by screwing 3 screws as shown in the Figure 1, max clamping torque is 1 Nm.

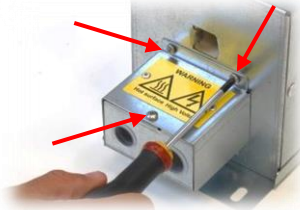

Figure 1

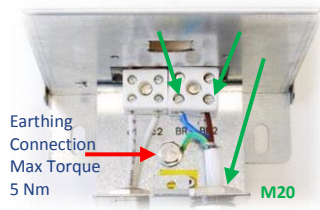

Figure 2 – power connection

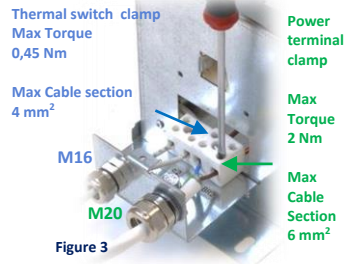

Figure 3

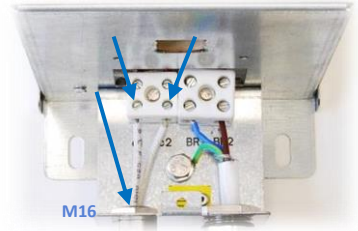
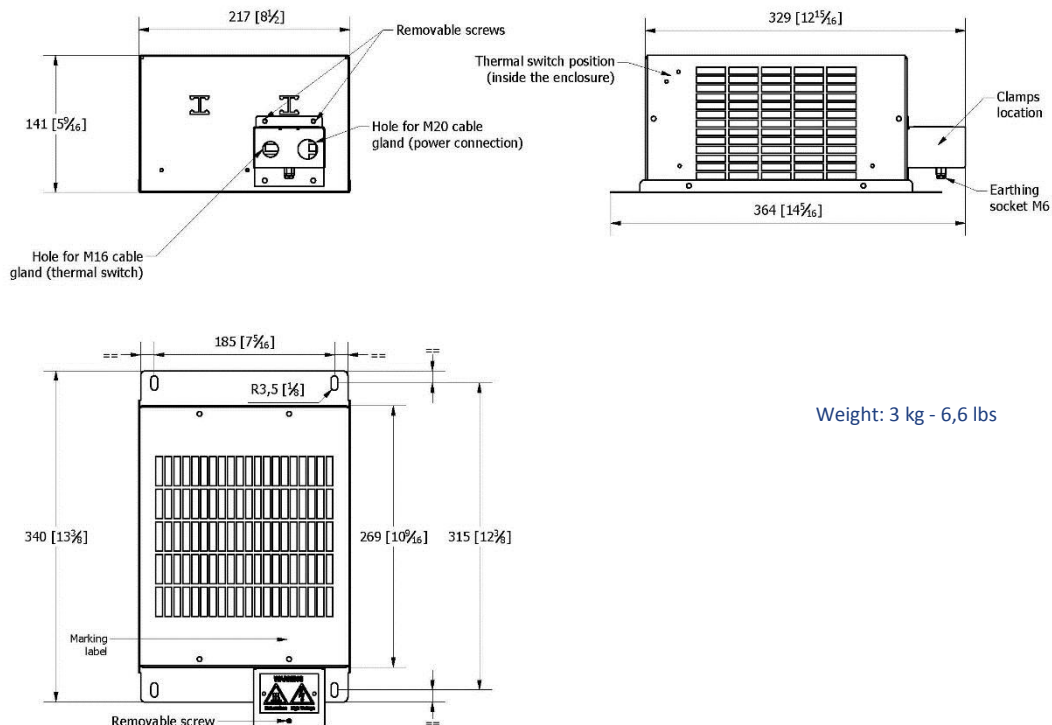

Figure 4 – thermal switch connection

9. Drawing



Weight: 3 kg - 6,6 lbs